

Three Wide Unassembled Six High Box Locker Units With or Without Legs

RETAIN INSTRUCTIONS FOR FUTURE REFERENCE

.....



GENERAL SAFETY INFORMATION

Some parts may have sharp edges. CARE must be taken when handling various pieces to avoid injury. For safety, wear a pair of work gloves when assembling or performing any maintenance on units.

.....

LIMITED WARRANTY

Tennsco warrants goods purchased hereunder to be free of defects in materials and workmanship for a period of one (1) year from the date of shipment, hereunder. This warranty shall not apply in the event goods are damaged as a result of misuse, abuse, neglect, accident, improper application, modification or repair by persons not authorized by Seller, where goods are damaged during shipment, or where the date stamps on the goods have been defaced, modified or removed. UNLESS CONSIDERED UNENFORCEABLE OR UNLAWFUL UNDER APPLICABLE LAW:

- a. ALL IMPLIED WARRANTIES, INCLUDING BUT NOT LIMITED TO WARRANTIES OR MERCHANTABILITY AND FITNESS FOR A PARTICULAR PURPOSE ARE HEREBY EXCLUDED:
- b. BUYERS REMEDY, IF ANY, FOR ANY DEFECTIVE GOODS SHALL BE LIMITED TO A REFUND BY SELLER OR REPLACEMENT OF THE GOODS AT SELLER'S OPTION, AND SHALL IN NO EVENT INCLUDE DAMAGES OF ANY KIND, WHETHER INCIDENTAL, CONSEQUENTIAL OR OTHERWISE.

NO GOODS ACCEPTED FOR RETURN WITHOUT PRIOR APPROVAL. Seller shall have the right to inspect any goods claimed to be defective at Buyers place of business or require Buyer to return the goods to Seller for inspection on Seller's premises. Transportation charges covering returned goods will be borne by Seller only if such goods are proven to be defective, are covered by this warranty and are returned within the warranty period stated above.

.....



PROUDLY MADE IN THE U.S.A.

Tennsco LLC., Dickson, TN 37056-1888 • (866) 446-8686

ASSEMBLY OF THREE WIDE BOX LOCKERS

Tools Needed: A provided 11/32" nut driver (11/32" socket may be substituted).

Two people are recommended for assembly. Approximate assembly time: 40-50 minutes.

1. The reference numbers used throughout this sheet refer to the illustration on the back cover. This is to help you to identify the various parts as they are mentioned.
2. Unpack all the parts then locate the left and right hand sides and separate them. The top of the sides and back can be determined by the three holes closest to the end of the part.
3. Place back (Ref. No. 1) on a protected flat surface so that the flanges face upward. Keep all parts level and square during assembly. Make sure all the parts are aligned properly before tightening the bolts and nuts (Ref. No. 13). Bolt the left side (Ref. No. 2) to the back so that the side flange fits around the back using seven nuts and bolts (nuts to the inside); use nine bolts and nuts if the locker does not have legs.

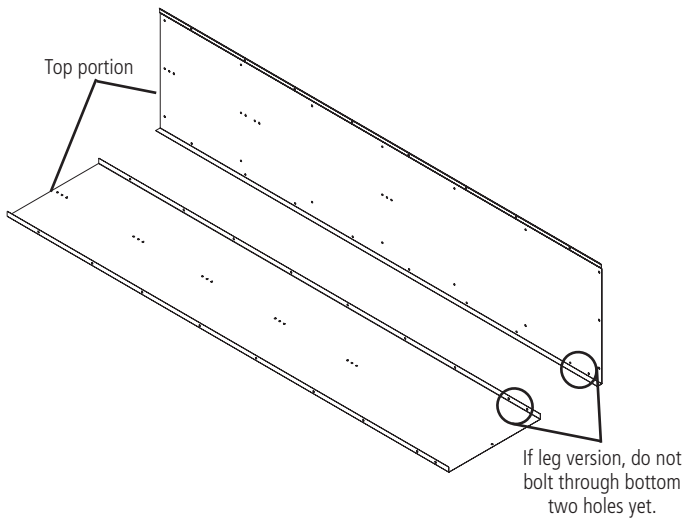

4. Bolt the shelves (Ref. No. 4), top and bottom (Ref. No. 5) to the back and left side panel using four nuts and bolts each. Next bolt an intermediate side and back panel to the flange on the back of the first locker in seven places (nine if no legs). Next attach a top, bottom, and shelves to the first intermediate side and back. These will share bolts with the parts on either side of them as shown in detail view. Next attach remaining intermediate side and back to the flange of the second back. Attach the remaining top, bottom, and shelves to the intermediate side.

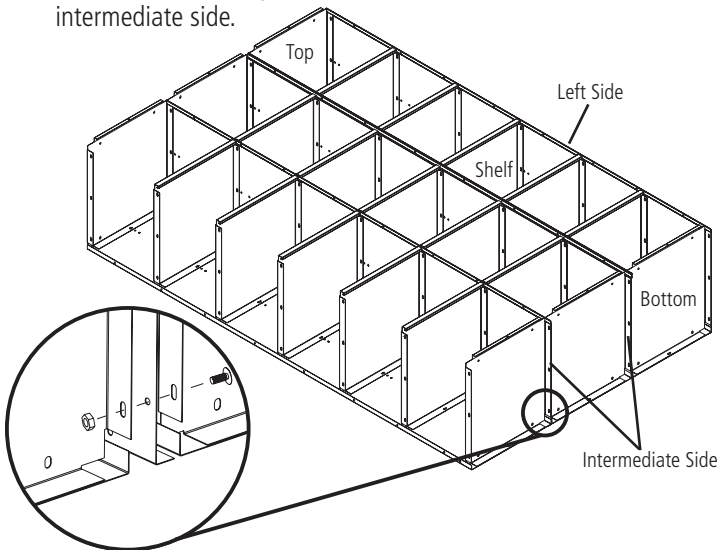

5. Next bolt the right side (Ref. No. 6) to the back so that the side flange fits around the back. Also attach to the top, bottom and shelves. Use twenty three bolts and nuts (for a unit without legs) to complete this step.

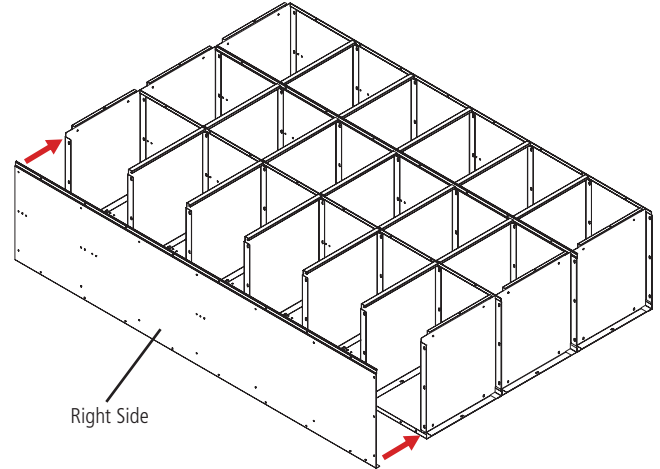

6. If the locker has legs, insert the leg into the corner between the bottom and the side. Bolt the leg to the side using two bolts and nuts per leg.

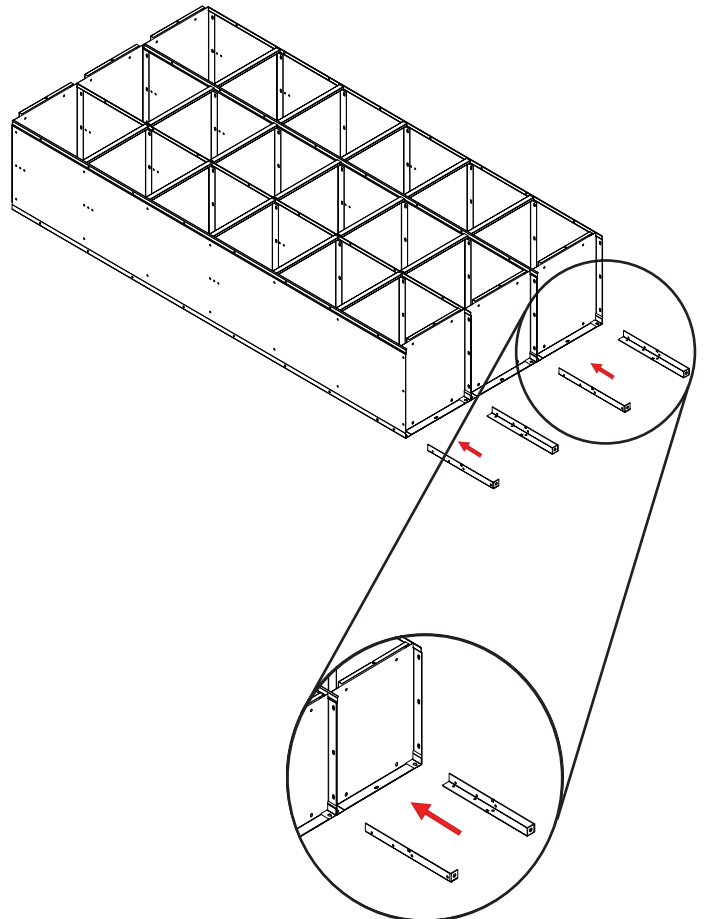

- Place the frame and door assembly (Ref. Nos. 7 & 8) over the locker body. Make certain that the body sides are inside the frames not between the frames. Attach the top to the frame header and the bottom to the frame sill using one bolt each.

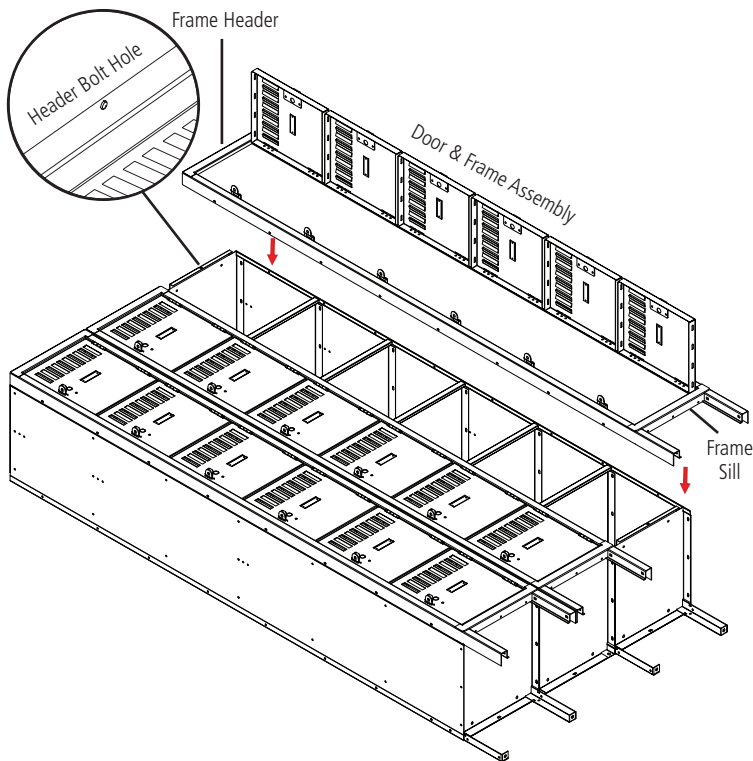

- If joining a three wide unit beside another unit, temporarily install only one bolt and nut into the third and sixth holes down from the top of the outer frame(s) that will be joined to the adjacent locker frame(s). The center locker frame can be bolted complete. If the locker is just a stand alone three wide unit, finish attaching the frames using thirty eight bolts and nuts. Check and tighten all permanent bolts.

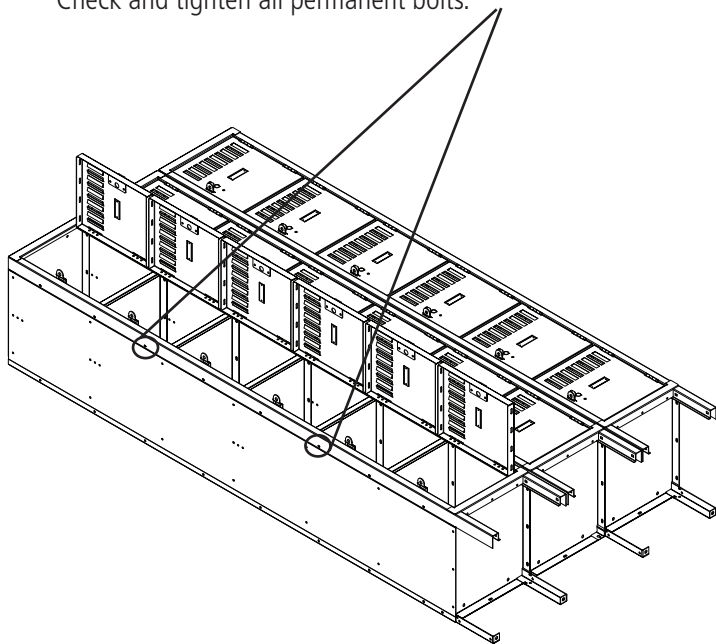

- Stand the unit upright and place in the desired location. Remove temporary bolts in frames and bolt to adjacent units together through frames.

NOTE: If the temporary bolts are not removed before the frames are joined side by side, the frames will have a 1/8" gap between them.

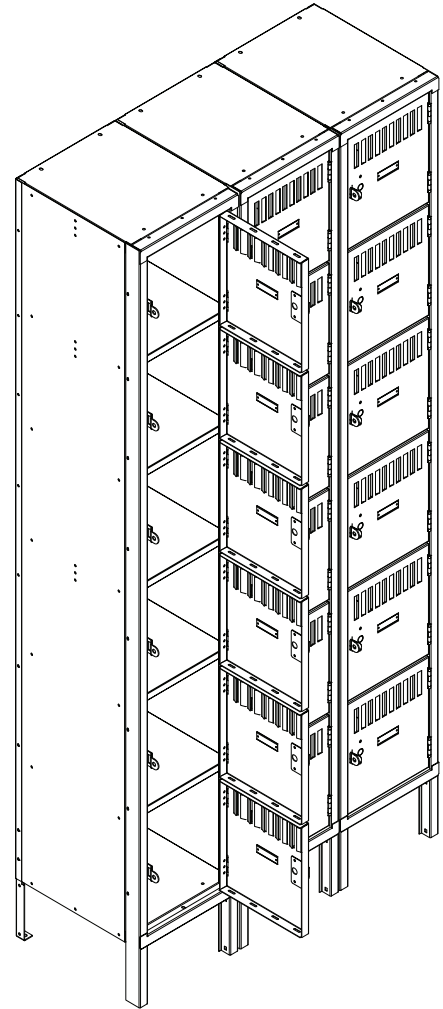

- Anchor units to wall or floor. The units are not intended to stand free and may topple if not secured. Units standing back to back should be bolted back to back.

NOTE: Care must be taken to assure that lockers are set plumb and level before anchoring.

- If units are not pre-numbered, optional number plates and plastic covers (Ref. No. 9) may be attached using push plugs (Ref. No. 10). Tensco name plate (Ref. No. 18) is installed at the factory. As an alternative, custom number or name plates may be ordered from the factory. Your locker is complete.
- If additional accessories were purchased such as End Bases/ Front Bases (for lockers with legs), Closed Bases (for lockers without legs), Slopping Tops, and/or Combination Locks or Grooved Key Locks, please see the instructions that came along with those parts.

REPLACEMENT PARTS

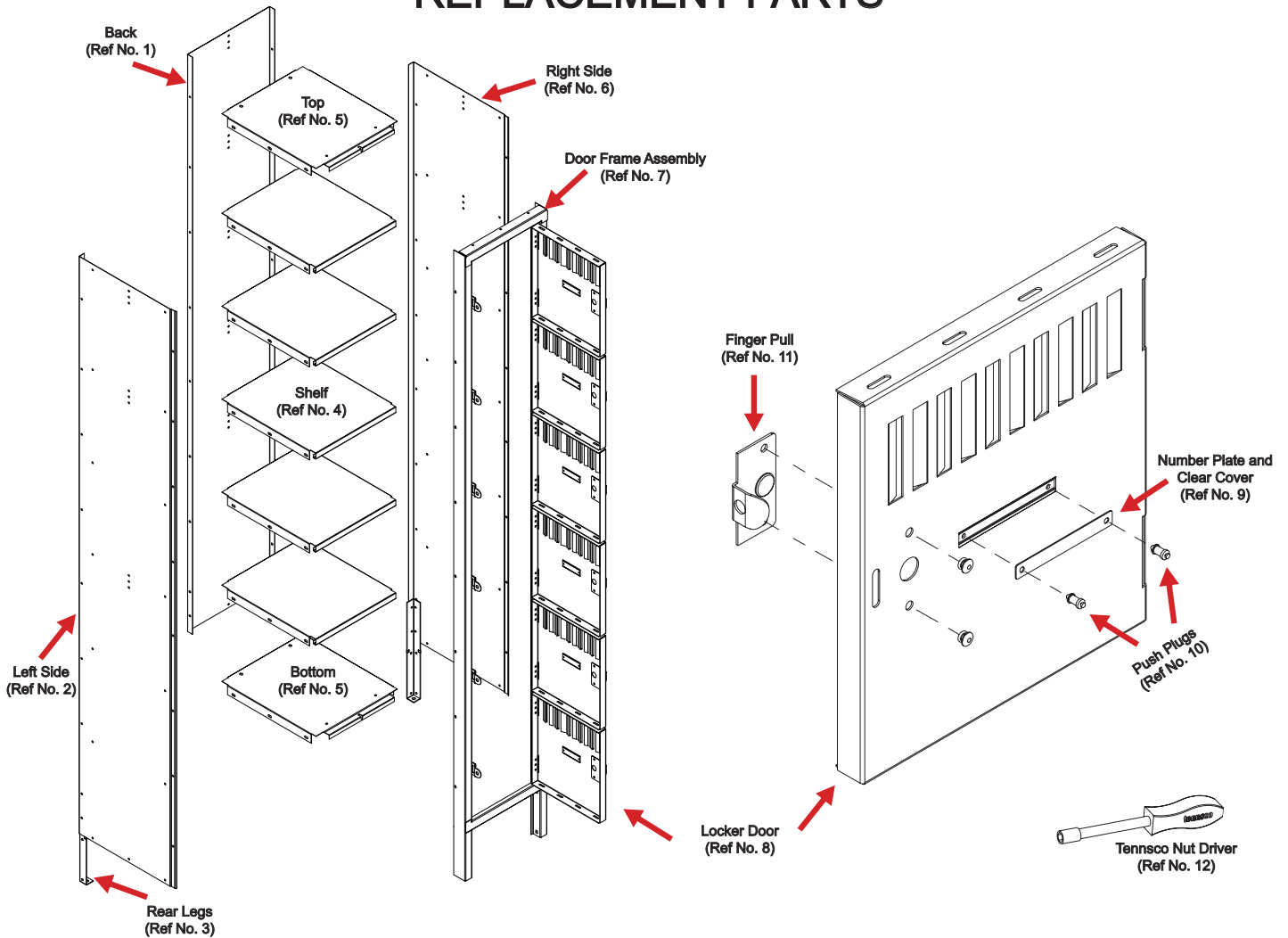

REF. NO.	DESCRIPTION	PART NO.	QTY.
1	Back	LSTB-wwhh	3
2	Left Side	LBSL-ddhh	2
3	Rear Leg (leg version unit only)	LRL-1	4
4	Shelf	ESL-wwdd	15
5	Top/Bottom	LTB-wwdd	6
6	Right Side	LBSR-ddhh	2
7	Door Frame Assembly	LBFA-wwhh-x	3
8	Locker Door	LB-wwhh	18
9	Paper Number Plate and Clear Cover*	LNP-1	18
10	Push Plug*	LPP-1	36
11	Finger Pull	LFP-1	18
12	Tensco Nut Driver*	TOOL-2	1
13	Bolts and Nuts #8-32 x 1/2" (not shown)*	**	144

*These items are included in the hardware pack enclosed (Part No.: HWBK6-3). **Available Locally

Part No. is composed of prefix shown plus combination of opening or unit. Width = ww and Depth = dd.

Door Frame assemblies require a further suffix (x) of either 1 or A. "1" indicates frame with legs; "A" indicates frame without legs. For example: A door frame assembly for locker BK6-121812-1 (with legs) would be Part No. LBFA-1272-1. The door assembly alone without the frame for the same locker would be Part No. LBD-1212.

NOTE: Additional hardware may be included for replacement purposes.

Tensco makes every effort to ensure that all units ship complete with all parts and arrive undamaged. However, should your unit contain missing or damaged parts, please contact your purchase location.