

## SPECIFICATIONS

## PRODUCT

|                       |   |
|-----------------------|---|
| USB                   | 5V  |
| CRI                   | >80   |
| Lumens                | 100 lm  |
| CCT                   | 3000K   |
| Life                  | 15,000 hrs  |
| Working Time          | 5.5 hours of continuous light                               |
| Charging Time         | 4 hrs   |
| Operating Temperature | During Charge: 50F to 113F<br>During Discharge: -4F to 140F |

## SAVE THESE INSTRUCTIONS

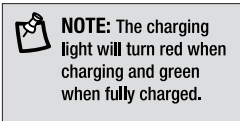

Model: BPUCLPUCK/830/BAT/3

## IMPORTANT SAFETY INSTRUCTIONS AND INSTALLATION GUIDE

### Rechargeable LED Motion Puck Light

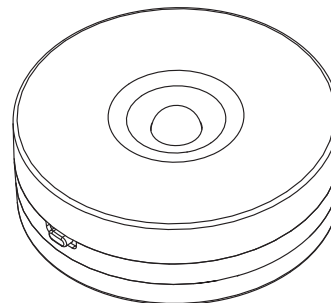

## READ BEFORE INSTALLATION SAVE THESE INSTRUCTIONS

Questions, problems, missing parts?  
Before returning to the store, call  
Feit Electric Customer Service  
8 a.m. - 5 p.m., PST, Monday - Friday

**1-866-326-BULB (2852)**

**FEIT.COM**

We appreciate the trust and confidence you have placed in Feit Electric through the purchase of this Rechargeable LED Motion Puck Light. We strive to continually create quality products designed to enhance your home. Visit us online to see our full line of products available for your home improvement needs.  
Thank you for choosing Feit Electric.

The performance specifications (lumens, watts, life and CCT) should only be considered an approximation of expected performances.

**LIMITED WARRANTY:** This product is warranted to be free from defects in workmanship and materials for up to 1 year from date of purchase. If the product fails within the warranty period, replacement or refund is your sole remedy. Except to the extent prohibited by applicable law, any implied warranties are limited in duration to the duration of this warranty. Liability for incidental or consequential damages is hereby expressly excluded. Some states and provinces do not allow the exclusion of incidental or consequential damages, so the above limitation or exclusion may not apply to you. This warranty gives you specific legal rights, and you may also have other rights which vary from state to state or province to province.

**Supplier's Declaration of Conformity:** 47 CFR § 2.1077 Compliance Information

Responsible Party: Feit Electric Company, 4901 Gregg Road, Pico Rivera, CA 90660, USA 562-463-2852

Unique Identifier: BPUCLPUCK/830/BAT/3

**FCC STATEMENT:** This device complies with part 15 of the FCC Rules. Operation is subject to the following two conditions: (1) This device may not cause harmful interference, and (2) this device must accept any interference received, including interference that may cause undesired operation. Note: This equipment has been tested and found to comply with the limits for a Class B digital device, pursuant to part 15 of the FCC Rules. These limits are designed to provide reasonable protection against harmful interference in a residential installation. This equipment generates, uses and can radiate radio frequency energy and, if not installed and used in accordance with the instructions, may cause harmful interference to radio communications. However, there is no guarantee that interference will not occur in a particular installation. If this equipment does cause harmful interference to radio or television reception, which can be determined by turning the equipment off and on, the user is encouraged to try to correct the interference by one or more of the following measures: Reorient or relocate the receiving antenna. Increase the separation between the equipment and receiver. Connect the equipment into an outlet on a circuit different from that to which the receiver is connected. Consult the dealer or an experienced radio/TV technician for help. Any changes or modifications not expressly approved by the manufacturer could void the user's authority to operate the equipment.

WWW.FEIT.COM

Please contact 1-866-326-BULB (2852) for further assistance.

## Important Safety Information

Read and understand all Safety and Operating instructions in this manual before using this product. Follow all safe guards stated in this manual, in addition to normal safety precautions in working with electrical devices.

- Do not place near any heat source.
- Do not place near any heat source.
- To reduce the risk of electrical shock, do not put in water or other liquid. Do not place or store product where it can fall or be pulled into a tub or sink.
- Do not crush or incinerate.
- Do not insert foreign objects into this product.
- To reduce the risk of fire, keep away from combustible materials while in operation.
- To reduce the risk of injury, close supervision is necessary when this product is used near children.
- Do not attempt to repair, disassemble or modify under any circumstances.

This product uses permanent tape that may cause damage to the mounted surface. Feit Electric is not responsible for any damage to the mounted surface.



**WARNING: RISK OF SHOCK.** House electric current can cause painful shock or serious injury unless handled properly.



**WARNING:** Changes or modifications to this unit not expressly approved by the party responsible for compliance could void the user's authority to operate the equipment.

## PARTS INCLUDED



**NOTE:**  
Hardware not shown to actual size.



| Part | Description                    | Quantity |
|------|--------------------------------|----------|
| AA   | Rechargeable Motion Puck Light | 1        |
| BB   | USB Type-C Charging Cable      | 1        |
| CC   | Double sided Adhesive          | 1        |
| DD   | Mounting Metal Plate           | 1        |

## LED Fixture Installation

### 1 Positioning the Motion Puck Light

Find the desired location for the Motion Puck Light and clean the area. Remove any dirt, dust or other residue.



### 2 Attaching the Double Sided Adhesive

Peel off the protective film from one side of the Double Sided Adhesive (CC)

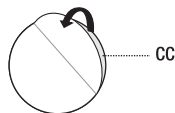

Attach the Double Sided Adhesive (CC) to the Mounting Metal Plate (DD).



### 3 Attaching the Mounting Metal Plates

Attach the Mounting Metal Plates (DD) to the top of the Puck Light (AA).

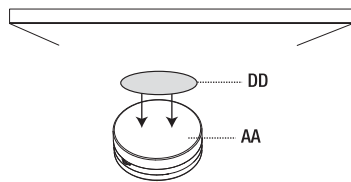

## LED Fixture Installation (continued)

### 4 Installing the Motion Puck Light

Peel off the other side of the adhesive (CC).

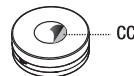

Position the Puck Light (AA) to the desired area. Press the Puck Light (AA) onto the surface and hold for 30 seconds to assure the Puck Light (AA) is held securely.

Note: After installation, the Motion Puck Light (AA) can be removed and reattached using the built in magnet.

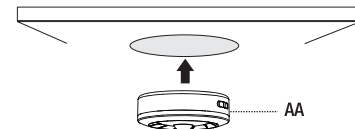

## Operating Instructions

### 1 Selecting a Function

ON – The puck light will stay on continuously until the battery discharges.

OFF – The puck light will stay off, regardless of motion.

Automatic (A) – The PIR sensor will detect motion to turn on the puck light. After not sensing motion for 15 seconds, the puck light will turn off.

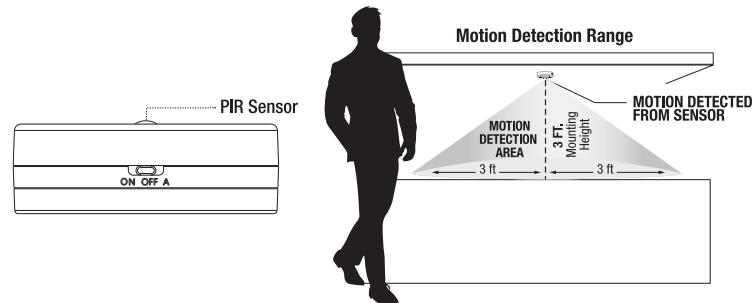

### 2 Charging the Motion Puck Light

Connect the included USB Type-C Charging Cable (BB) to the charging port on the Motion Puck Light (AA). The Charging indicator light on the Motion Puck Light (AA) will turn red when charging and green when fully charged.

