



Store 'n Go Sport 2-in-1 Booster

40-110 lb (18.1-49.9 kg)
43-57 in. (110.1-144.8 cm)



KEEP INSTRUCTIONS FOR FUTURE USE.

Read all instructions before using
this booster seat.

⚠ WARNING:

Failure to follow the warnings on the labels and
in the instruction manual can result in serious
injury or death to your child.

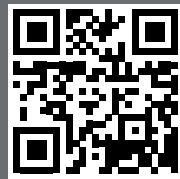









To see installation videos, scan the QR Code
or visit www.safety1st.com

©2017 Dorel Juvenile.



4358-7323
7.10.17

Table of Contents

 Getting Started.....1	
Parts of the Booster Seat 1	
 General Use3	
Preparing Seat 3	
Installing Seat Pad.....3	
Attaching Headrest to Backrest..... 5	
Attaching Backrest to Base 5	
Adjusting Backrest 6	
Adjusting Headrest 6	
Removing Backrest..... 7	
Storage Drawer 8	
Removing Seat Pad for Cleaning..... 9	
 Safety Information.....11	
Booster Seat Use..... 11	
Installation in Vehicle 12	
Vehicle Seating Position 12	
 Vehicle Information14	
Understanding Your Vehicle 14	
Knowing Your Vehicle Belts..... 15	
Aircraft Information 16	
 Booster Seat with Backrest.....17	
 Lap and Shoulder Belt Installation 18	
 Booster Seat without Backrest ..20	
 Lap and Shoulder Belt Installation 21	
 Important Information..... 23	
Dorel Juvenile Group Information..... 23	
Registration and Safety Notices 24	
Troubleshooting..... 25	
Replacement Parts Order Form..... 26	
Warranty..... 28	

Parts of the Booster Seat

Front View

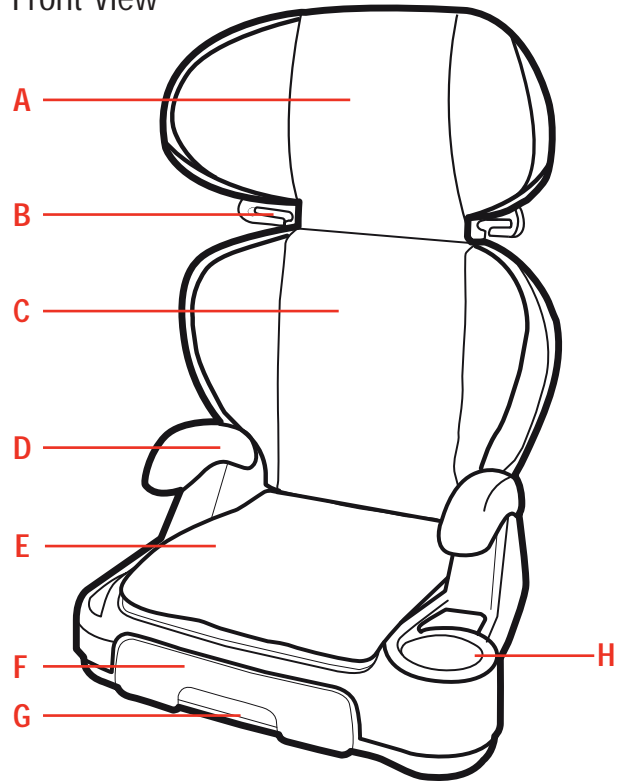

- A. Headrest
- B. Shoulder Belt-Positioning Guide
- C. Backrest
- D. Armrest
- E. Seat Base
- F. Storage Drawer

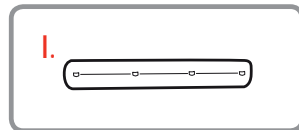

- G. Storage Drawer Lock
- H. Cup Holder
- I. Plastic Snap Strip For Seat Base Pad

1

Back View

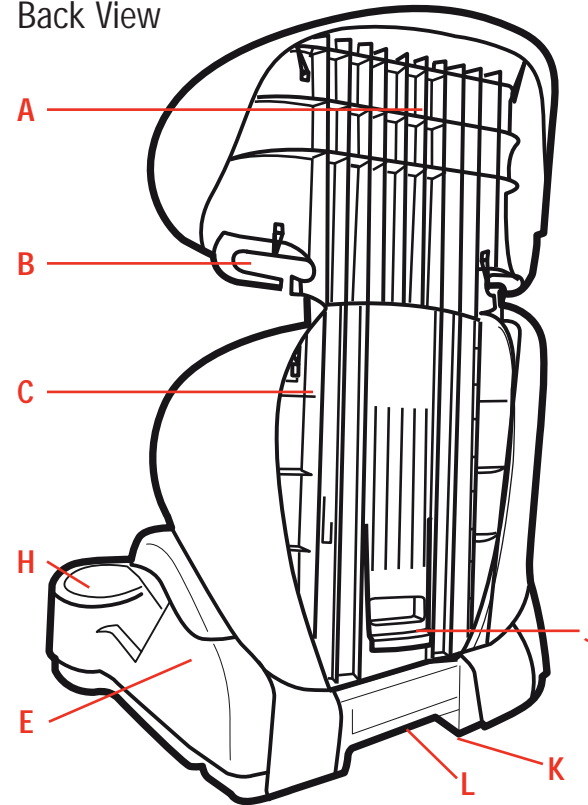

- J. Headrest Adjustment Lock
- K. Instruction Manual Storage (under seat bottom)
- L. Backrest Lock (under the seat bottom)

2



Preparing Seat

Note: Depending on your model, you may need to prepare the seat for use.

Installing Seat Pad

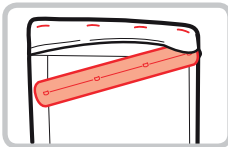

1. Insert Plastic Snap Strip into Front of Seat Pad

Push locking tabs in the holes on the front of the seat base pad, as shown.

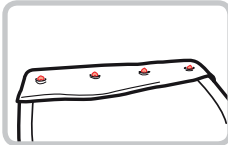

2. Attach Seat Base Pad

Push in the locking tabs into the holes on the front of the seat base.

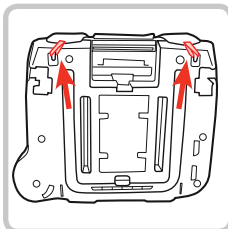

3. Fasten Elastic Straps to Bottom of Seat Base

From bottom of seat base, fasten elastic straps.

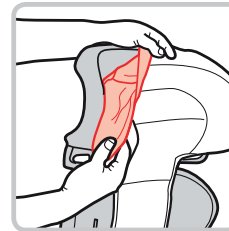

4. Attach Headrest Pad

Slide the headrest pad over one side of the headrest, then the other.

From the back of the headrest, attach the elastic straps to the hooks at the top and bottom.

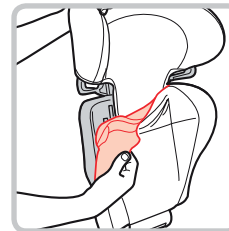
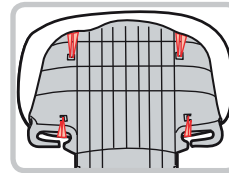

5. Attach Backrest Pad

Slide backrest pad onto one side of the backrest. Pull pad tight and slide the pad over the other side of the backrest.

Bottom of the headrest pad should be behind the backrest pad as shown.

⚠ WARNINGS: Do not use this booster seat without the seat pad. Failure to do this can result in serious injury.

NOTE: The backrest and headrest are removable. The headrest and backrest must always be used together.

To use as a backed booster, attach headrest to backrest and backrest to seat base, as follows.

Attaching Headrest to Backrest

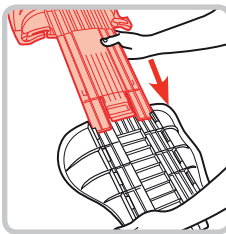

With the back of the headrest and backrest facing up, slide the headrest into the track on the back of the backrest.

Pull headrest adjuster lock out and pull headrest down into a locked position.

Attaching Backrest to Base

Note: Headrest **MUST** always be used when using backrest. If headrest has been removed from backrest.

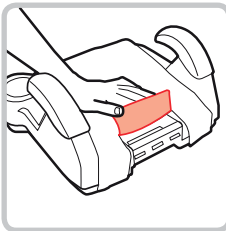

1. Find Backrest Connection Slot

Lift flap on seat pad as shown to reveal backrest connection slot.

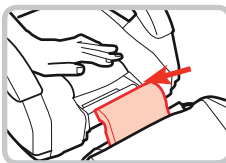

2. Attach Backrest to Seat Base

Insert the hook on the backrest into the backrest connection slot.

Make sure backrest is laying flat (horizontal) when connecting.

NOTE: Make sure seat pad does not get caught between the moving parts. The backrest may not connect properly if the pad is in the way.

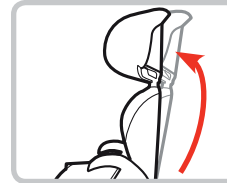

3. Rotate Backrest Up Until It Clicks into Place

Tuck seat pad flap under backrest flap.

Adjusting Backrest

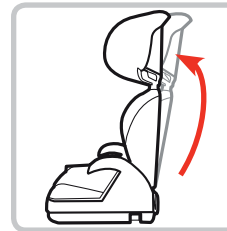

1. Rotate Backrest Forward or Back to Desired Position

The backrest should be flush with vehicle seat back angle.

Adjusting Headrest



1. Raise or Lower Headrest to Selected Position

This booster seat has multiple headrest positions. Grasp top of headrest and push down with one hand while pulling out on the headrest adjustment lock with the other.

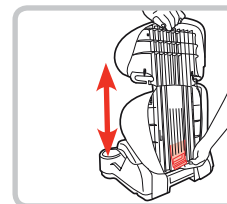

Raise and lower headrest into selected position. Release the headrest adjustment lock into one of the many headrest heights.

Make sure headrest is locked by sliding headrest up and down. Headrest may move slightly when it is locked.



Removing Backrest

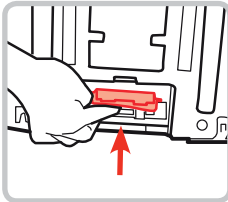

1. Unlock the Backrest

Locate the backrest lock and pull the tab down. At the same time, lay the base down so that the seat is flat.

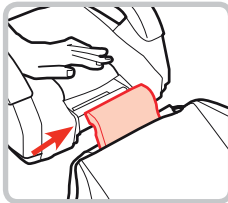

2. Remove Backrest from Seat Base

With the seat base and backrest lying flat, lift up on the backrest to release the backrest hook from the seat base.

Storage Drawer

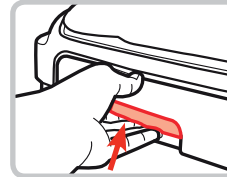

To open storage drawer:

Squeeze up on the drawer lock and pull out.

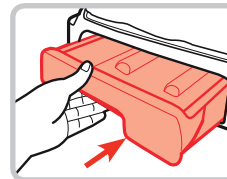

To close storage drawer:

Push in drawer until it is flush with the seat.

⚠ WARNINGS: Only use storage drawer for storing your child's gear. Keep storage drawer closed when not in use. Failure to do this can result in serious injury.



Removing Seat Pad for Cleaning

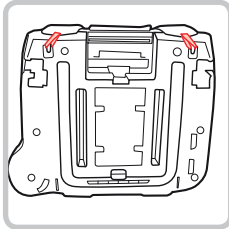

1. Unfasten the Elastic Strap on Bottom of Base

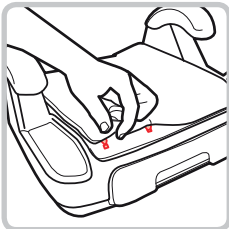

2. Pull the Lock Tabs Out of Front of Base

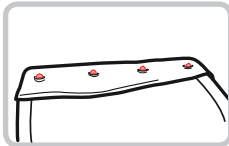

3. Remove Plastic Snap Strip from Front of Seat Pad

Pull locking tabs out of the holes on the front of the seat base pad, as shown.

Remove plastic snap strip. Place the snap strip in the storage drawer so it does not become lost.

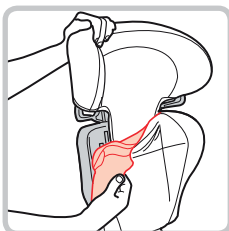
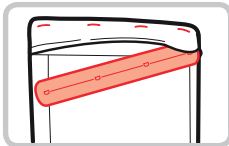

4. Remove Backrest Pad

Pull backrest pad out from around backrest shell.

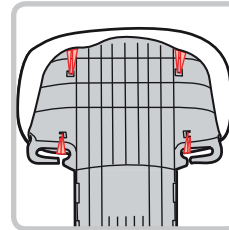

5. Unfasten Elastic Straps

From the back of headrest, unfasten the elastic straps.

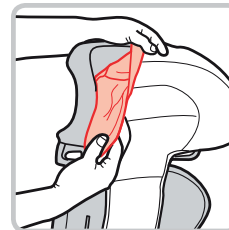
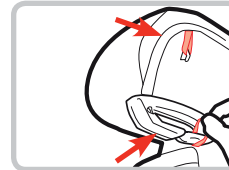

6. Remove Headrest Pad

Gently pull pad off headrest.

Cleaning Seat Pad

Machine wash separately with cold water on a gentle cycle. Do not use bleach. Tumble dry separately for 10-12 minutes on low heat. Remove immediately.

Replacing Pad

To replace the pad, see pages 3-4.



Booster Seat Use

Never take your child out of the booster seat while the vehicle is moving.

Never leave child unattended.

Placing your child in a hot booster seat may result in burns.

Do not use a booster seat with damaged or missing parts.

Do not substitute parts or try to modify the booster seat in any way.

Do not use any booster seat accessory except those approved by Dorel Juvenile Group.

Never allow any child to play with this booster seat; it is not a toy.

Do not remove or cover up any of the warning labels or other labels on the booster seat.

On the side of the booster seat there is a date of manufacture label. Do not use this booster seat more than 10 years after date of manufacture.

Read all instructions and warning labels for additional warnings.

Installation in Vehicle



Check the vehicle belt before each use. Use only if the belt can be tightened properly and securely.

This booster seat should be securely belted in the vehicle even when not in use. In a crash or sudden stop, an unsecured booster seat could injure occupants.

Do not use a booster seat that has been in a crash. You must get a new booster seat.

Vehicle Seating Position



Check the vehicle owner's manual for more information about air bag/booster seat use.

For vehicles without a back seat, refer to your vehicle owner's manual.



Use the booster seat only on vehicle seats that face forward.



Do not use on seats that face the sides or rear of the vehicle.

Some vehicles do not have a seating position that can be used safely with this booster seat. If you are not sure where to place the booster seat in your vehicle, consult your vehicle owner's manual, contact Dorel Juvenile Group Consumer Care Department, or visit your local Child Passenger Inspection Station. Go to <http://www.safercar.gov/cpsApp/cps/index.htm> to find your closest station.



Children are safer when properly restrained in rear seating positions than in the front seating positions.

According to National Highway Traffic Safety Administration information, children in rear seating positions are statistically safer, whether you have air bags, advanced air bags, or no air bags at all.

To avoid your child being seriously burned, take the following precautions:

1. Park in the shade or where sun does not directly hit the booster seat.
2. Always use the booster seat with the seat pad.

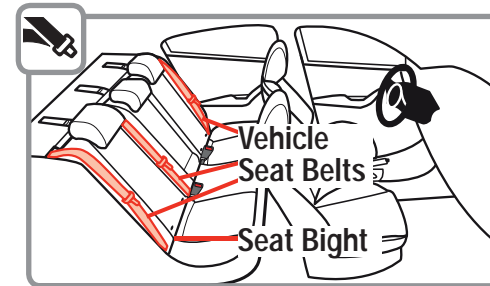

Your vehicle's features may be considerably different than those pictured here.

Consult your vehicle owner's manual to help identify your vehicle's specific features and locations.



Not all vehicle belts and seating positions will work with booster seats.

You must review your vehicle's owner manual for vehicle seat belt use with booster seats.

Never Use With This Booster Seat	
Lap Belt Only	✗
Inflatable Seat Belts	✗



This booster seat is not certified for aircraft use because aircraft seats do not have shoulder belts.



Booster Seat with Backrest

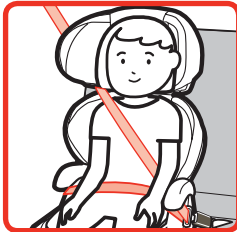

40-110 lb (18.1-49.9 kg)
43-57 in. (110.1-144.8 cm)



Lap/Shoulder Belt

The American Academy of Pediatrics recommends that children remain in a five-point harness until they outgrow their forward-facing harnessed child restraint.

This typically occurs around age 4, but some children outgrow them sooner and others not until later.

Please talk to your doctor about the best option for your child.



⚠ WARNINGS: Do not use this booster seat if the tops of your child's ears are above the top of the vehicle seat back, vehicle headrest or booster seat headrest.

Use only the vehicle's lap and shoulder belt system when restraining the child in this booster seat.



Do not use only the lap belt.

The shoulder belt must always be adjusted snugly across the child's chest.

NEVER place the shoulder belt under the child's arms.

Failure to follow these warnings can result in serious injury or death.

Lap and Shoulder Belt Installation



To attach headrest to backrest, see page 5.

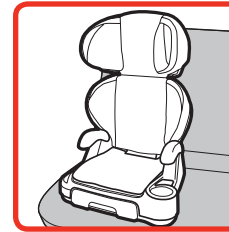

1. Place Booster Seat Forward-Facing Flush Against Vehicle Seat Back



2. Place Child in Booster Seat

Child should sit with their back and bottom flush against the booster seat's back and bottom.

Tops of the child's ears should never be above the top of the vehicle seat back, vehicle headrest or booster seat headrest. Adjust headrest if needed, see page 6.

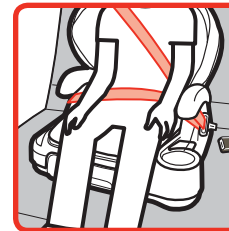

3. Position Lap Belt on Child

Route lap portion of the lap/shoulder belt under both armrests.

The shoulder belt **MUST GO UNDER** the armrest on the vehicle buckle side.

The lap belt should lay snugly across the child's upper thighs and not on the stomach, as shown.

Booster Seat without Backrest

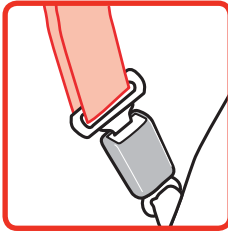

4. Buckle Vehicle Belt



5. Position Shoulder Belt on Child

Pull up on the shoulder belt to tighten.

The shoulder belt should lay snugly across the center of the child's shoulders and across the chest and not on the face or neck.

To help position the shoulder belt, you may need to secure the shoulder belt in one of the two shoulder belt-positioning guides behind headrest pad.

NOTE: Use the shoulder belt positioning guide only if necessary to correctly position the shoulder belt on the child.

Check periodically to ensure your child has not moved out of position and loosened the shoulder belt.



40-110 lb (18.1-49.9 kg)
43-57 in. (110.1-144.8 cm)



Lap/Shoulder Belt

The American Academy of Pediatrics recommends that children remain in a five-point harness until they outgrow their forward-facing harnessed child restraint.

This typically occurs around age 4, but some children outgrow them sooner and others not until later. Please talk to your doctor about the best option for your child.

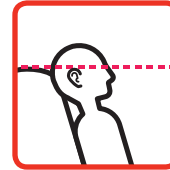

⚠ WARNINGS: Do not use this booster seat if the tops of your child's ears are above the top of the vehicle seat back or headrest.

Use only the vehicle's lap and shoulder belt system when restraining the child in this booster seat.

Do not use only the lap belt. The shoulder belt must always be adjusted snugly across the child's chest.

NEVER place the shoulder belt under the child's arms.

Failure to follow these warnings can result in serious injury or death to your child.



By the nature of the design, backless booster car seats do not have a back or headrest. These types of booster car seats help position the vehicle belt across the body.

Any additional protection of the body or head is dependent on the protection systems of your vehicle. Please consider this when choosing where this booster will be used in your vehicle and always consult your vehicle owner's manual.



Lap and Shoulder Belt Installation

To remove backrest from seat base, see page 7.



1. Place Booster Seat Forward-Facing Flush Against Vehicle Seat Back and Bottom



2. Place Child in Booster Seat

Child should sit with their back flat against the vehicle seat and bottom flat against the booster seat.



3. Position Lap Belt on Child

Route lap portion of the lap/shoulder belt under both armrests.

The shoulder belt **MUST GO UNDER** the armrest on the vehicle buckle side.

The lap belt should lay snugly across the child's upper thighs and not on the stomach.

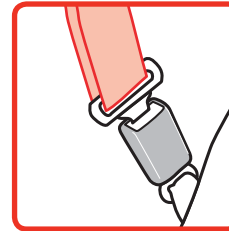

4. Buckle Vehicle Belt



5. Position Shoulder Belt on Child

Pull up on the shoulder belt to tighten.

The shoulder belt should lay snugly across the center of the child's shoulders and across the chest and not on the face or neck.

Check periodically to ensure you child has not moved out of position and loosened the shoulder belt.

NOTE: If the shoulder belt lays incorrectly, attach the backrest (see page 5) or order a belt positioning clip by using the Replacement Parts List or by calling Consumer Care at 1-800-544-1108.

Dorel Juvenile Group Information

Thank you for choosing this booster seat. The DJG family is committed to creating child restraints with the most comfort and convenience available today.

Remember, parents are a child's first teachers and examples. If you always buckle your seat belt, your child will think it is the natural thing to do. Make it a firm rule that the vehicle does not go until everyone is buckled up. Make no exceptions.

No one can predict if use of a child restraint will prevent injury or death in a particular crash. However, when combined with careful driving, proper use of a child restraint can lower a child's risk of injury or death in most crashes.

Your child's safety is worth the time it will take to read and follow these instructions. After reading, if you still have questions or have any concerns with this booster seat, please contact our Consumer Care Department at:

Website: www.safety1st.com

Telephone: 1-800-544-1108

M-TH from 8 A.M. to 6 P.M. EST
FRI from 8 A.M. to 4:30 P.M. EST

Mailing Address:

Dorel Juvenile Group, Inc.
Consumer Care Department
P.O. Box 2609
Columbus, IN 47202-2609

Registration and Safety Notices

Please complete the postage-paid registration card that came with your booster seat, and send it to us. Child restraints could be recalled for safety reasons. You must register this restraint to be reached in a recall. Send your name, address, email address if available and the restraint's model number and manufacturing date to:

**Dorel Juvenile Group, Inc.
Consumer Care Department**

PO Box 2609
Columbus, IN 47202-2609

or call 1-800-544-1108 or register online at www.djgusa.com/registration/carseat/us.

For recall information, call the U.S. Government's Vehicle Safety Hotline at 1-888-327-4236 (TTY: 1-800-424-9153), or go to <http://www.NHTSA.gov>.

Consumer: Just fill in your name, address and email. Please print (use dark ink).

Your Name _____
Your Street Address _____
City _____ State _____ Zip Code _____

Model Number	Line Code	Manufacture Date
AB123CDE	S1 CARSEAT	01/22/2015

Model Name _____
Manufacture Date _____

Model Number: AB123CDE Model Name: S1 CARSEAT Manufacture Date: 01/22/2015

Barcode: [Barcode] L#11 B265035

Example of model number, manufacture date, and line code.

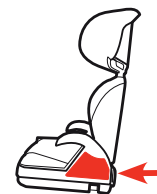

If you don't have the card or if your address changes, you will find the model number, manufacture date, and line code on the label located on side of shell.

Troubleshooting

If the shoulder belt crosses the child's neck when using the booster seat:

Try moving the booster seat toward the center of the vehicle or move the vehicle seat forward or back. Check to see if your vehicle has adjustable shoulder belt anchor points.

⚠ WARNING: NEVER place the shoulder belt behind the child.

Replacement Parts Order Form

Complete the form. Your model number and manufacturer date code **MUST** be included on the form to ensure proper replacement parts. The codes can be found on a label on side of booster seat. Payment in U.S. dollars must accompany your order. Choose parts needed from the list on the next page. Return the form with payment to:

Dorel Juvenile Group, Inc.
Consumer Care Department
P.O. Box 2609
Columbus, IN 47202-2609

Please make money orders payable to Dorel Juvenile Group, Inc. Fill in the area on the next page to charge credit card. (Visa or MasterCard **only**). We do not accept cash, personal checks, or other credit cards. All outside of U.S. and Canada **MUST** use credit card.

Ship To: (Please Print)

Name: _____

Address: _____

City: _____

State/Province: _____ **Zip:** _____

Telephone: _____

Email Address: _____

We **MUST** have this information:

Model Number (8 to 9 characters): _____

Manufacture Date (mm/dd/yyyy): _____

Replacement Parts List

NOTE: If requested color is not available, similar color will be substituted. Prices are subject to change.

Part	Cost	Qty	Total Cost
Seat Pad Set.....	\$19.99	\$.....
Belt Positioning Clip.....	\$0.99	\$.....
Instructions.....	\$0.00	\$.....
Merchandise Total:			\$.....

Shipping and handling:			\$.....
Up to \$25.00	\$5.95	\$100.01 to \$150.00	\$10.95
\$25.01 to \$50.00	\$6.95	\$150.01 to \$200.00	\$11.95
\$50.01 to \$75.00	\$8.95	\$200.01 and up.....	\$13.95
\$75.01 to \$100.00	\$9.95	Outside Continental USA.....	\$10.00

Sales Tax \$.....

(Arizona, California, Georgia, Indiana, Missouri, South Carolina, and Texas residents add applicable sales tax.)

Grand Total..... \$.....

No shipping and handling on instructions for quantities under 6. Add \$.50 for each instruction over 6, then add applicable shipping and handling.

Fill Out For Credit Card

Visa MasterCard

Card Exp. Date:

Cardholder's Name:

Card Number:

Signature:

CUT ON DOTTED LINE

Warranty

Dorel Juvenile Group, Inc. (DJG) warrants this product to the original retail purchaser as follows:

This product is warranted against defective materials or workmanship for one year from the date of original purchase.

An original receipt is required to validate your warranty.

DJG will, at its option, provide replacement parts or replace this product. DJG reserves the right to substitute if the part or model has been discontinued.

To make a claim under this warranty you may write to DJG, Consumer Care Department, P. O. Box 2609, Columbus, IN 47202-2609; or call 1-800-544-1108 from 8:00 a.m. to 6:00 p.m. EST Monday through Thursday and from 8:00 a.m. to 4:30 p.m. on Friday.

Proof of purchase is required and shipping charges are the responsibility of the consumer.

Warranty Limitations: This warranty does not include damages which arise from misuse or abuse of this product.

Limitation of Damages: The warranty and remedies as set forth are exclusive and in lieu of all others, oral or written, expressed or implied. In no event will DJG or the dealer selling this product be liable to you for any damages, including incidental or consequential damages, arising out of the use or inability to use this product.

Limitation of warranties and other warranty terms and state law rights:

Any implied warranties, including implied warranties of the merchantability and fitness for a particular purpose, shall be limited to the duration and terms of the express written warranty. Some states do not allow limitations as to how long an implied warranty lasts or the exclusion or limitation of incidental or consequential damages, so the above limitations may not apply to you.

This warranty gives you specific legal rights, and you may have other rights, which vary from state to state. Neither DJG nor the dealer selling this product authorized any person to create for it any other warranty, obligation, or liability in connection with this product.