

MODEL: SLP109E
1500LPH SOLAR PUMP KIT
ASSEMBLY INSTRUCTIONS
READ AND SAVE THESE INSTRUCTIONS

UNPACK THE PACKAGE
 YOU SHOULD HAVE RECEIVED LISTED PARTS:

- 1PC PUMP WITH 5M CABLE;
- 1PC LED LIGHT RING WITH 5M CABLE,
- 1PC BATTERY BOX,
- 1PC SOLAR PANEL WITH 2M CABLE,
- 1PC SOLAR PANEL BRACKET,
- 2PC EXTENSION TUBES
- 1PC GROUND SPIKE.
- 1PC FOUNTAIN NOZZLES

TO PROTECT THE PRODUCT, PLACE ALL ON A SOFT SURFACE BEFORE ASSEMBLY.

1. JOIN THE BRACKET, TUBES AND SPIKE TOGETHER AND THEN ATTACH THE SOLAR PANEL TO THE BRACKET. SLIDE THE HOLDING BRACKET INTO THE INSIDE LIP OF THE TOP HALF OF THE SOLAR PANEL FRAME. THE HOLDING BRACKET HOLDS THE WEIGHT OF THE SOLAR PANEL. THE DIRECTION TOWARDS THE SUNLIGHT CAN BE ADJUSTED WITH THE WINGNUT. SEE DIAGRAM.

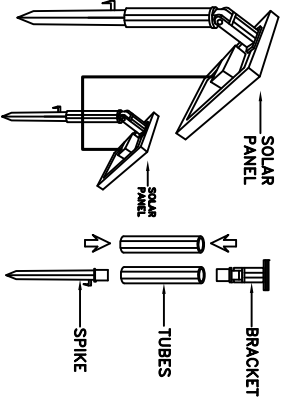

2. INSERT THE SPIKE INTO THE GROUND. POSITION THE SOLAR PANEL TO FACE SOUTH (In Northern Hemisphere) AS MUCH AS POSSIBLE TO MAKE THE MOST OF THE DAYLIGHT HOURS. IT IS IMPORTANT TO ANGLE THE SOLAR PANEL TO FACE SUN WHEN SUN IS AT ITS HIGHEST POINT. ENSURE THE SOLAR PANEL IS NOT SHADED BY TREES, SHRUBS OR BUILDINGS.

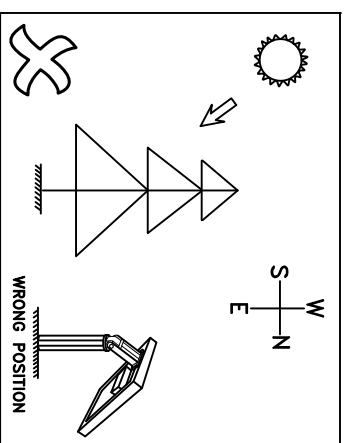
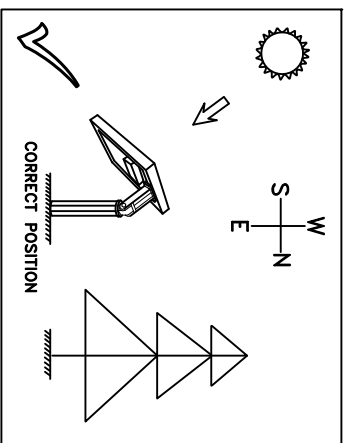

3. CONNECT THE SOLAR PANEL, PUMP, LED LIGHT TO THE BATTERY BOX (SEE DIAGRAM BELOW):

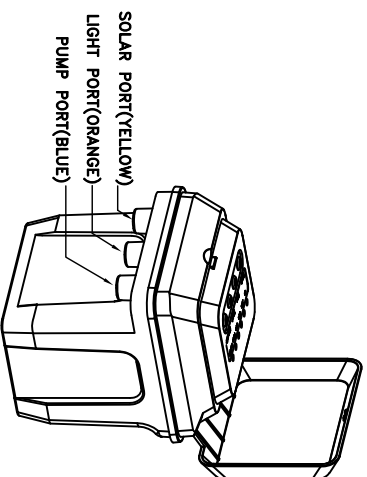

IMPORTANT!
 SLIGHTLY TWIST THE CONNECTORS WHEN PUSHING, MAKE SURE THEIR RUBBER SEALS FULLY IN GROOVES

MODEL: SLP109E
1500LPH SOLAR PUMP KIT
OPERATING INSTRUCTIONS
READ AND SAVE THESE INSTRUCTIONS

4. YOUR SOLAR PUMP KIT SHOULD LOOK LIKE THIS AFTER ASSEMBLY:

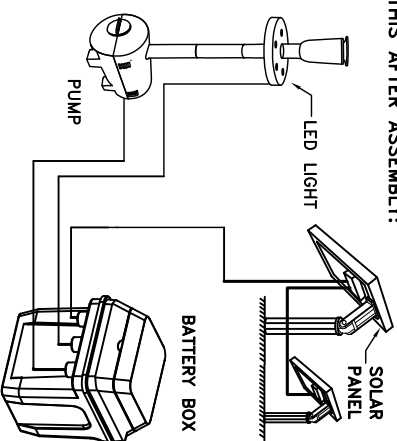

5. OPERATION

CONTINUAL USE MODE: PRESS BUTTON [Power], INDICATOR LIGHT [On] LIT, PUMP WILL WORK CONTINUOUSLY UNTIL BATTERY RUNS OUT OF ALL POWER.

TIMER FUNCTION MODE: PRESS BUTTON [Timer], INDICATOR LIGHT [2hrs] LIT, PUMP WILL BE ON FOR 2 HOURS, OFF FOR 22 HOURS, AND REPEAT THIS TIMING SET EVERY DAY AT THE SAME TIME. TO SELECT 3HRS OR 4HRS TIMER BY PRESSING THE BUTTON [Timer] REPEATEDLY UNTIL INDICATOR LIGHT [3hrs] or [4hrs] LIT. THE PUMP WILL BE ON FOR 3hrs, OFF FOR 21hrs AT 3hrs TIMER SET, ON FOR 4hrs, OFF FOR 20hrs AT 4hrs TIMER SET.

WINTER MODE: PRESS BUTTON [Winter], INDICATOR LIGHT [Pulse] LIT, PUMP WILL BE ON FOR 20 SECONDS IN EVERY 60 SECONDS. WE RECOMMEND TO USE THIS MODE TO EXTEND BATTERY LIFE TIME IN WINTER OR IN POOR WEATHER.

PUMP FLOW CONTROL: PRESS BUTTON [Flow rate] REPEATEDLY TO ADJUST THE PUMP FLOW RATE (3 LEVELS FOR SELECTION). NOTE: HIGHER FLOW RATE WILL COST MORE POWER AND REDUCE THE BATTERY LIFE TIME.

LOW BATTERY: IF YOU FIND THE INDICATOR LIGHT [Low Bat.] BLINKING, THAT MEANS BATTERY POWER LOW, SYSTEM WILL SHUT OFF THE PUMP/LED LIGHT SHORTLY TO PROTECT THE BATTERY. [Low Bat.] LIGHT STEADY ON. THE PUMP/LED LIGHT CAN NOT WORK UNTIL BATTERY IS RECHARGED.

6. PERFORMANCE OF PUMP

THE PERFORMANCE OF THE PUMP DEPENDS ON THE ORIENTATION OF THE SOLAR PANELS TOWARD THE SUN AND SUN LIGHT STRENGTH. THE MAXIMUM DATA OBTAINED UNDER OPTIMAL CONDITIONS. A FEATURE IN THE SHADE OR ON CLOUDY DAYS CAN NOT BE GUARANTEED. FOR THIS MODEL WITH BATTERY, THE PERFORMANCE OF PUMP ALSO DEPEND ON BATTERY POWER LEVEL, PUMP CAN NOT WORK IF BATTERY POWER IS USED OUT.

7. MAINTENANCE OF PUMP

IF YOU FIND THE PUMP START LOSING POWER OR STOP WORKING, PLEASE CLEAN THE PUMP FILTER AND IMPELLER WITH CLEAN WATER.

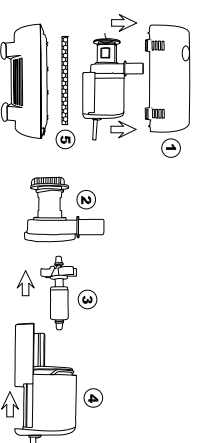

- ① PUMP CASE ② IMPELLER COVER
- ③ IMPELLER ④ PUMP ⑤ FILTER

8. BATTERY INFORMATION

RECHARGABLE BATTERY BECOMES LESS EFFICIENT WITH REPEATED CHARGE AND DISCHARGE CYCLES. THE CAPACITY OF THE BATTERY MAY ALSO REDUCE OVER TIME AND YOU MAY NOT ACHIEVE THE FULL HOURS OPERATION. IF YOU FIND THAT THE BATTERY APPEAR LESS EFFICIENT TRY TO BOOST CHARGE IT. TO DO THIS LEAVE OFF FOR 2 TO 3 SUNNY DAYS TO ALLOW THE MAXIMUM CHARGE TO THE BATTERY. WE SUGGEST TO DO THIS OCCASIONALLY TO HELP PROLONG BATTERY SERVICE LIFE. IF AFTER THIS BOOST CHARGE YOUR BATTERY STILL DOES NOT PERFORM TO EXPECTATIONS YOU SHOULD REPLACE IT WITH A NEW BATTERY.

MODEL: SLP109E
1500LPH SOLAR PUMP KIT
OPERATING INSTRUCTIONS
READ AND SAVE THESE INSTRUCTIONS

9. BATTERY REPLACEMENT

AFTER USED FOR 12 TO 18 MONTHS, THE BATTERY HAS REACHED IT'S SERVICE LIFE, YOU SHOULD REPLACE THE OLD BATTERY.

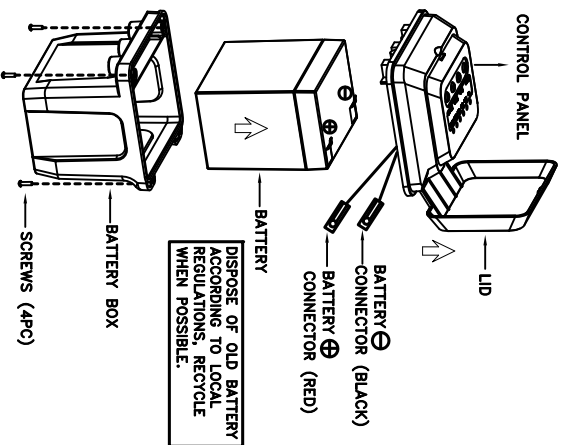

TOOLS NEEDED:
MEDIUM SIZED PHILLIPS HEAD SCREWDRIVER.

- 9.1 REMOVE THE SCREWS FROM BATTERY BOX
- 9.2 REMOVE THE LID AND CONTROL PANEL FROM THE BATTERY BOX SLIGHTLY.
- 9.3 DISCONNECT THE OLD BATTERY FROM THE CONTROL PANEL, REMOVE AND REPLACE THE OLD BATTERY.

REPEAT STEP 9.1 AND 9.2 AND 9.3 IN REVERSE ORDER TO REASSEMBLE.

WARNING!

WHEN YOU REPLACE THE BATTERY, MAKE SURE YOU CONNECT THE NEW BATTERY WITH CONTROL PANEL CORRECTLY: RED LEAD TO BATTERY ⊕, BLACK LEAD TO BATTERY ⊖. IT WILL DAMAGE THE PRODUCT PERMANENTLY AND AVOID THE GUARANTEE IF THE BATTERY IS INSTALLED INCORRECTLY.

10. PROBLEM SHOOTING

CHECK SOLAR PANEL, PUMP, LED LIGHT ARE CONNECTED WELL.

CHECK SOLAR PANEL CORRECTLY POSITIONED IN SUNNY PLACE, ENSURE THE SOLAR PANEL NOT SHADED BY TREES, SHRUBS OR BUILDINGS (SEE STEP 2).

CHECK [Low Bat.] LIGHT ON, THAT MEANS BATTERY POWER IS LOW, LEAVE THE BATTERY CHARGING BY SOLAR FOR 1 OR 2 SUNNY DAYS.

CHARGING TIPS: PRESS BUTTON [Power] TO TURN OFF THE PUMP, ALL INDICATOR LIGHTS WILL BE OFF. NOW ALL SOLAR CHARGES WILL GO FOR BATTERY CHARGING, AND THE BATTERY WILL BE RE-CHARGED MORE QUICKLY.

CHECK WATER LEVEL, MAKE SURE THE PUMP IS FULLY SUBMERGED IN WATER.

CHECK THE FOUNTAIN TUBING FOR KINKS AND OBSTRUCTIONS.

CHECK THE PUMP FILTER /IMPELLER BLOCKED BY DEBRIS

CHECK THE PUMP MAY BE "AIR LOCKED", TURN ON/OFF THE PUMP SEVERAL TIMES TO CLEAR ANY AIR THAT MAY HAVE BEEN TRAPPED.

11. TECHNICAL DATE

MAX. WATER FLOW: 1500 LPH
MAX. WATER LIFT: 300 CM
MAX. FOUNTAIN HEIGHT: 160CM
WORKING VOLTAGE: DC15V -DC18V
WORKING POWER: 6.6W-11.2W
PROTECTION GRADE OF PUMP: IP68

SOLAR PANEL: 2PC X 10W-18V-0.555A
SOLAR PANEL SIZE: 2PC X 350X285X18 MM
PROTECTION GRADE OF PANEL: IP44

BATTERY: LEAD ACID 12V/5AH
PROTECTION GRADE OF BATTERY BOX: IP44
THE TEMPERATURE RANGE WITHIN WHICH THE BATTERY CAN BE RE-CHARGED IS 0°C TO 45°C.
CHARGING THE BATTERY AT TEMPERATURES OUTSIDE THIS RANGE MAY CAUSE DAMAGE TO THE BATTERY OR REDUCE THE BATTERY LIFE SPAN.

LED LIGHT WORKING VOLTAGE: DC12V
MAX. WORKING POWER: 0.12W
PROTECTION GRADE OF LED LIGHT RING: IP68

MODEL: SLP109E
1500LPH SOLAR PUMP KIT
OPERATING INSTRUCTIONS
READ AND SAVE THESE INSTRUCTIONS

12. WINTER PROTECT

INDOOR STORAGE IS RECOMMENDED FOR THE WINTER IN HARSH CLIMATES.

IMPORTANT!!!

IN ORDER TO KEEP YOUR BATTERY HEALTHY DURING LONG TIME STORAGE PLEASE MAKE SURE YOU RECHARGE THE BATTERY FULLY BEFORE WINTER STORAGE. IN ORDER TO DO THIS, YOU CAN TURN OFF THE PUMP AND LEAVE THE BATTERY CHARGING BY THE SOLAR PANEL FOR 1 OR 2 SUNNY DAYS, SEE STEP 10 - CHARGING TIPS.

13. WARRANTY

THANK YOU FOR CHOOSING SUNNYDAZE DECOR. IF YOU HAVE ANY QUESTIONS, COMMENTS OR CONCERNS PLEASE FEEL FREE TO CONTACT US BY PHONE AT: 888-881-4688. BY EMAIL: CUSTOMERSERVICE@SERENITYHEALTH.COM, OR YOU COULD ALSO EMAIL US VIA OUR CONTACT US PAGE AT: WWW.SERENITYHEALTH.COM/CONTACT-US/.

WE STAND BEHIND OUR BRAND AND THE QUALITY OF THE ITEMS WE SELL. WE WILL SEND NEW PARTS, OR REPLACE PRODUCTS AT OUR DISCRETION WITHIN **THE ONE YEAR WARRANTY PERIOD**. BEFORE WE CAN HELP, YOU WILL NEED TO PROVIDE PROOF OF PURCHASE WITH THE DATE OF PURCHASE AND PHOTOS OF THE DEFECTIVE MERCHANDISE. WE WILL USE THE PHOTOS TO DETERMINE THE CAUSE OF DEFECT AND FOR FUTURE QUALITY CONTROL.

