







ASSEMBLY INSTRUCTION

ITEM: 638-85520-85 Alpine Four-Door Credenza

Thank you for purchasing this quality product. Be sure to unpack carefully looking for small parts which may have come loose during shipment.

Read all instruction and study the drawing carefully before starting the assembly process.

HARDWARE PACK				
NO.	DRAWING	DESCRIPTION	SIZE	Q'TY
A		Flat Washer	Ø5/16"	8 PCS
B		Lock Washer	Ø5/16"	8 PCS
C		Bolt	Ø5/16"*50mm	8 PCS
D		Allen Wrench	73*29*5mm	1 PC
E		Anti - Tip Kit		1 PC

PARTS LIST			
NO.	DRAWING	DESCRIPTION	Q'TY
①		Case Body	1 PC
②		Leg	4 PCS

Tipping Restraint

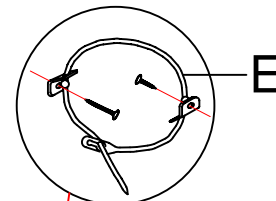

Anti-tip kit is included for use. We recommend installing for safety reason.

The adjustable shelves are screwed in place to avoid damage during transit. To adjust the shelf height, remove screws then place shelf pins in the desired level.

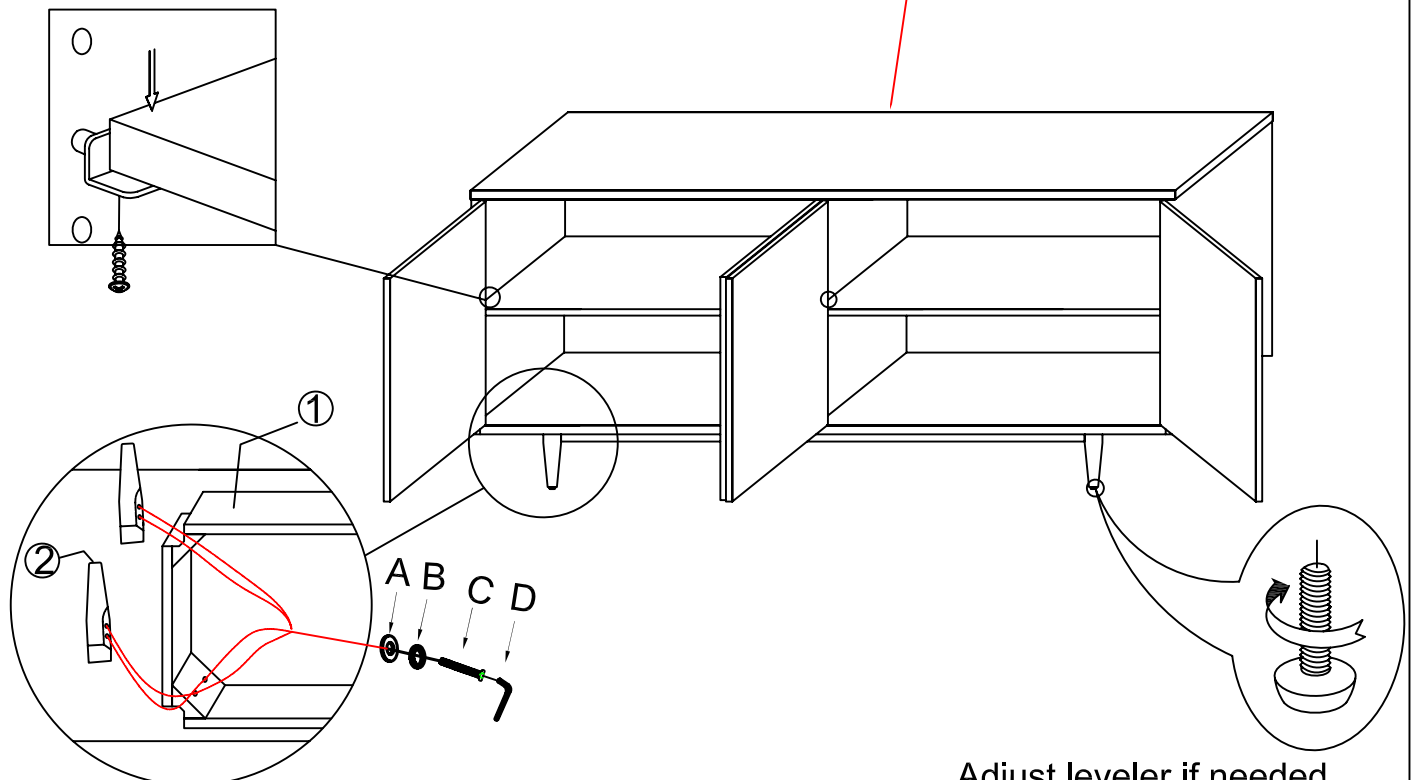

Please follow numbers on legs and corner blocks when assembling legs to the credenza.

Adjust leveler if needed to level credenza on uneven floor.

Note: Anti-tip kit restraint is provided.
Please follow the instructions enclosed with the pack.