

SPECIFICATIONS

DESCRIPTION

- Length cannot be cut down

WARRANTY

- Most products or parts carry "Limited Warranties" against manufacturing defects. For US customers please visit houseofrohl.com/support and for Canadian customers please visit houseofrohl.ca/support for complete product and finish warranty.



Lombardia®
30" Towel Bar

MODEL: L01/30

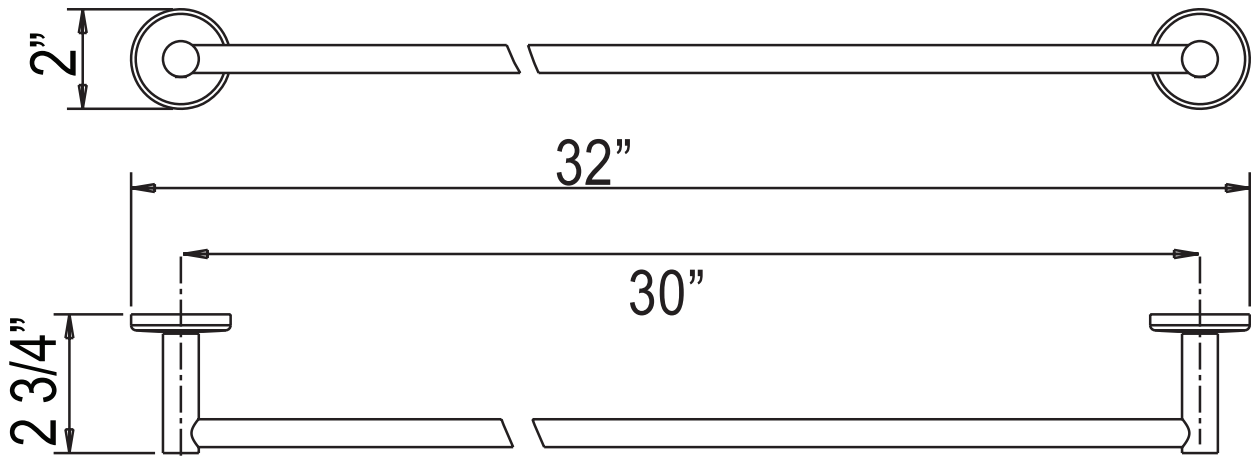

For warranty or additional information, contact:

U.S.A.
houseofrohl.com/support
1-800-777-9762

QUEBEC / MARITIMES / WESTERN CANADA
QUÉBEC / MARITIMES / OUEST CANADIEN
QUEBEC / MARITIMOS / CANADA OCCIDENTAL
houseofrohl.ca/support
1-866-473-8442

ONTARIO
houseofrohl.ca/support
1-800-287-5354

SPÉCIFICATIONS

DESCRIPTION

- La longueur ne peut pas être réduite

GARANTIE

- La plupart des produits ou pièces comportent des « garanties limitées » contre les défauts de fabrication. Pour les clients américains, veuillez visiter houseofrohl.com/support et pour les clients canadiens, veuillez visiter houseofrohl.ca/support pour la garantie complète du produit et du fini.



Lombardia®

Porte-serviette mural 30"

MODÈLES: L01/30

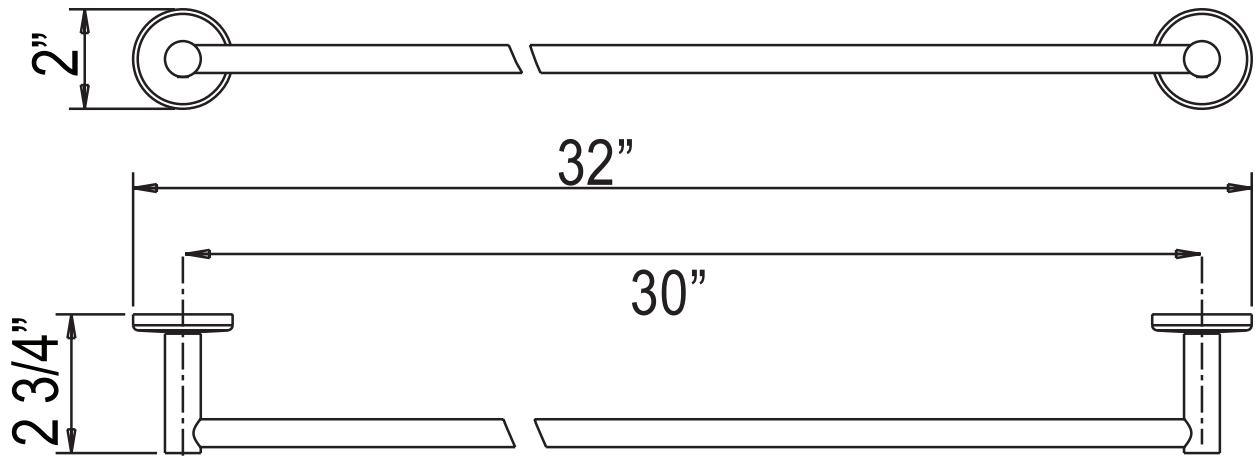

For warranty or additional information, contact:

U.S.A.
houseofrohl.com/support
 1-800-777-9762

QUEBEC / MARITIMES / WESTERN CANADA
 QUÉBEC / MARITIMES / OUEST CANADIEN
 QUEBEC / MARITIMOS / CANADA OCCIDENTAL
houseofrohl.ca/support
 1-866-473-8442

ONTARIO
houseofrohl.ca/support
 1-800-287-5354

ESPECIFICACIONES

DESCRIPCIÓN

- La longitud no se puede reducir

GARANTÍA

- La mayoría de los productos o piezas cuentan con "Garantías limitadas" contra defectos de fabricación. Para los clientes de EE. UU., visite houseofrohl.com/support y para los clientes canadienses, visite houseofrohl.ca/support para conocer la garantía completa del producto y el acabado.



Lombardia®

Toallero de pared de 30"

MODELOS: L01/30

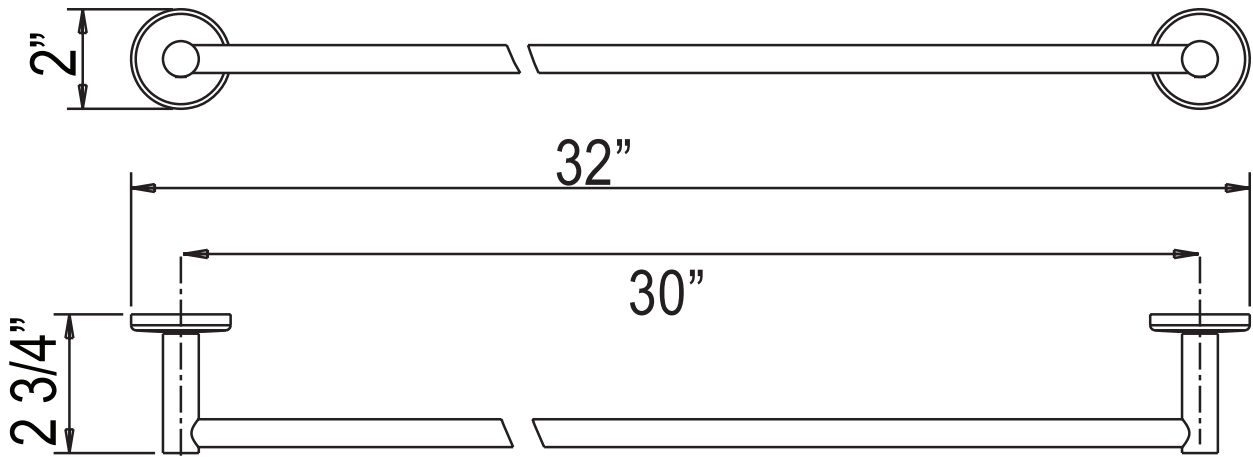

For warranty or additional information, contact:

U.S.A.
houseofrohl.com/support
 1-800-777-9762

QUEBEC / MARITIMES / WESTERN CANADA
 QUÉBEC / MARITIMES / OUEST CANADIEN
 QUEBEC / MARITIMOS / CANADA OCCIDENTAL
houseofrohl.ca/support
 1-866-473-8442

ONTARIO
houseofrohl.ca/support
 1-800-287-5354