

ELR-0496

**Mobile Dry-Erase & Flannel
 Room Divider. Split 3-Panel**

**Separador de ambientes móvil
 de franela y borrado en seco.**

Panel de 3 divisiones

**Séparateur de pièce mobile en
 flanelle et effaçable à sec.
 Réparti en trois panneaux**



EASY
 FÁCIL
 FACILE

HARD
 DIFÍCIL
 DIFFICILE

*Keep extra parts as replacements or to connect additional panels
 Guardar las piezas extra como recambio o para reconectar
 paneles adicionales*

*Conserver les pièces supplémentaires pour les remplacer ou
 pour connecter des panneaux supplémentaires*

A

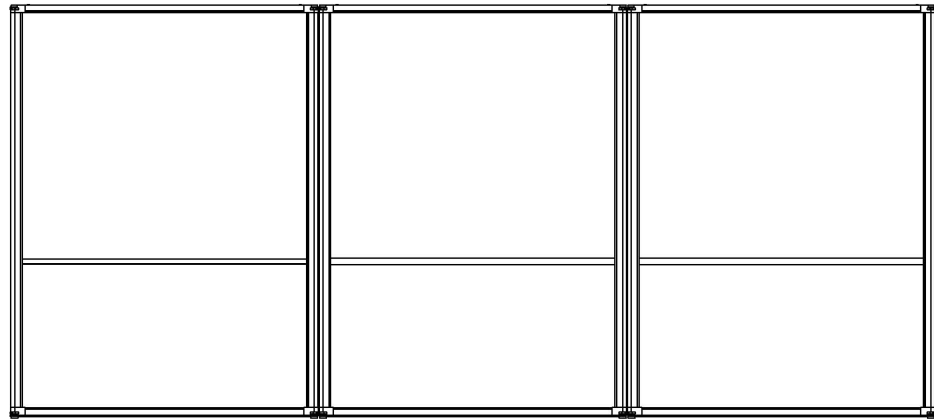

3-PANEL 1x
 6-PANEL 2x
 9-PANEL 3x

B

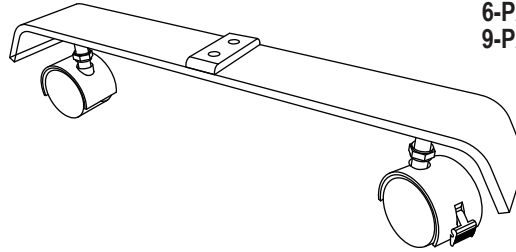

3-PANEL 4x
 6-PANEL 7x
 9-PANEL 9x

F

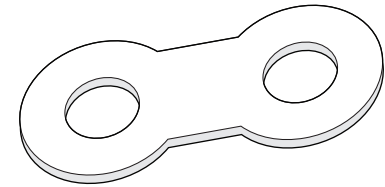

3-PANEL 0
 6-PANEL 2x
 9-PANEL 4x

C

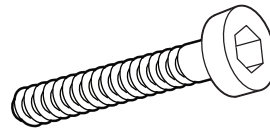

3-PANEL 8x
 6-PANEL 14x
 9-PANEL 18x

G

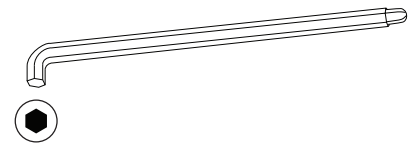

1x

D

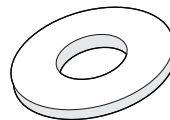

3-PANEL 8x
 6-PANEL 14x
 9-PANEL 18x

H

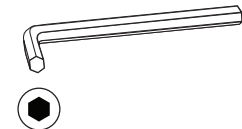

1x

E

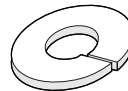

3-PANEL 8x
 6-PANEL 14x
 9-PANEL 18x

I

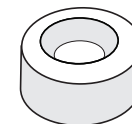

Installed
 Instalado
 Installé

J

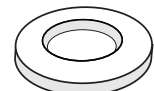

Installed
 Instalado
 Installé

1 CHECK PLACEMENT OF CONNECTORS ON BOTTOM OF PANELS

COMPRUEBE LA COLOCACIÓN DE LOS CONECTORES EN LA PARTE INFERIOR DE LOS PANELES

VÉRIFIER L'EMPLACEMENT DES CONNECTEURS SUR LE BAS DES PANNEAUX

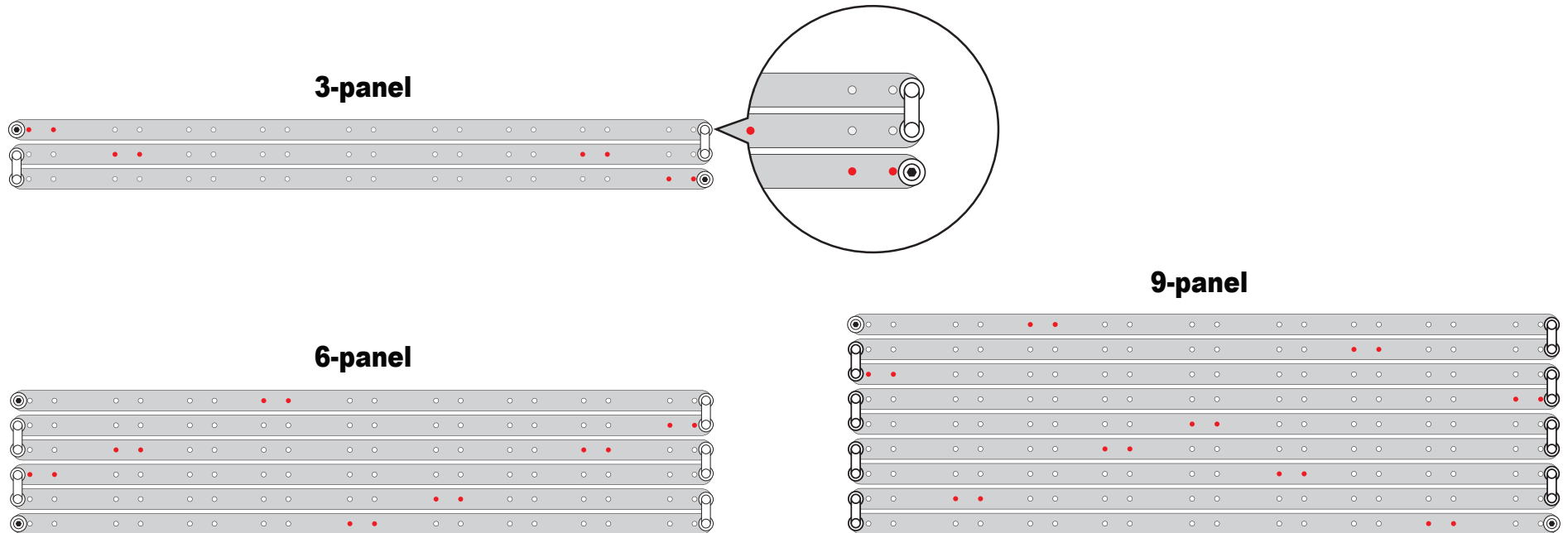

2

TO ALIGN CONNECTORS, YOU MAY NEED TO UNFOLD THE 3-PANEL UNIT AND REFOLD IN OPPOSITE DIRECTION.

PARA ALINEAR LOS CONECTORES, PUEDE QUE SEA NECESARIO QUE DESDOBLE LA UNIDAD DE 3 PANELES Y LA VUELVA A DOBLAR EN EL SENTIDO OPUESTO.

POUR ALIGNER LES CONNECTEURS, VOUS DEVREZ PEUT-ÊTRE DÉPLIER L'UNITÉ À TROIS PANNEAUX ET LA REPLIER DANS LA DIRECTION OPPOSÉE.

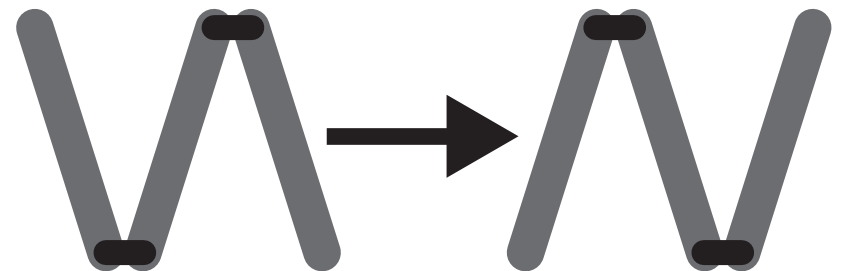

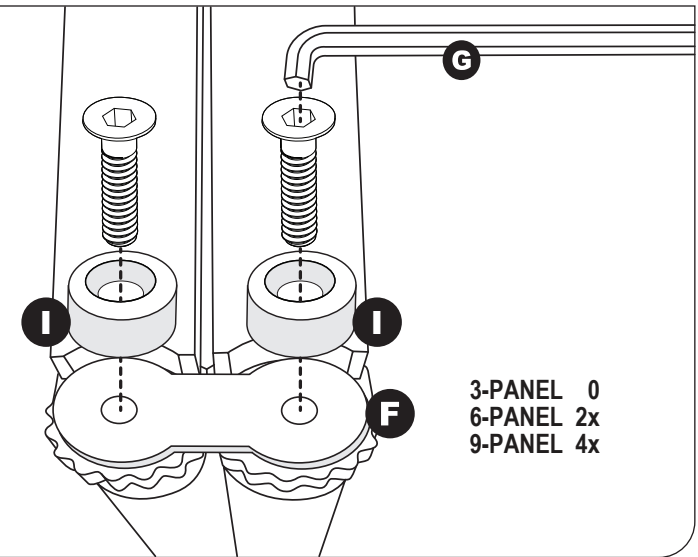
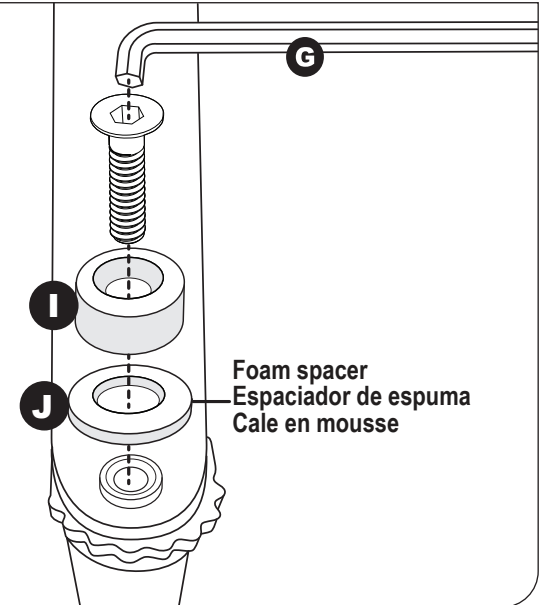
3**HOW TO REMOVE AND REATTACH CONNECTORS****CÓMO QUITAR Y VOLVER A COLOCAR LOS CONECTORES****COMMENT RETIRER ET REFIXER LES CONNECTEURS****4****INCLUDE FOAM SPACER (J) ON PANELS WITH NO CONNECTION****INCLUYA EL SEPARADOR DE ESPUMA (J) EN LOS PANELES SIN CONEXIÓN****INCLURE UN INTERCALAIRE EN MOUSSE (J) SUR LES PANNEAUX SANS RACCORD****5****CHECK THAT THE PLACEMENT OF TOP CONNECTORS MATCHES UP WITH BOTTOM CONNECTORS****COMPRUEBE QUE LA COLOCACIÓN DE LOS CONECTORES SUPERIORES ENCAJA CON LA DE LOS INFERIORES****VÉRIFIEZ QUE L'EMPLACEMENT DES CONNECTEURS SUPÉRIEURS CORRESPOND À CELUI DES CONNECTEURS INFÉRIEURS**

6

CONNECTING THE CASTERS CONEXIÓN DE LAS RUEDAS RACCORDLEMENT DES ROULETTES

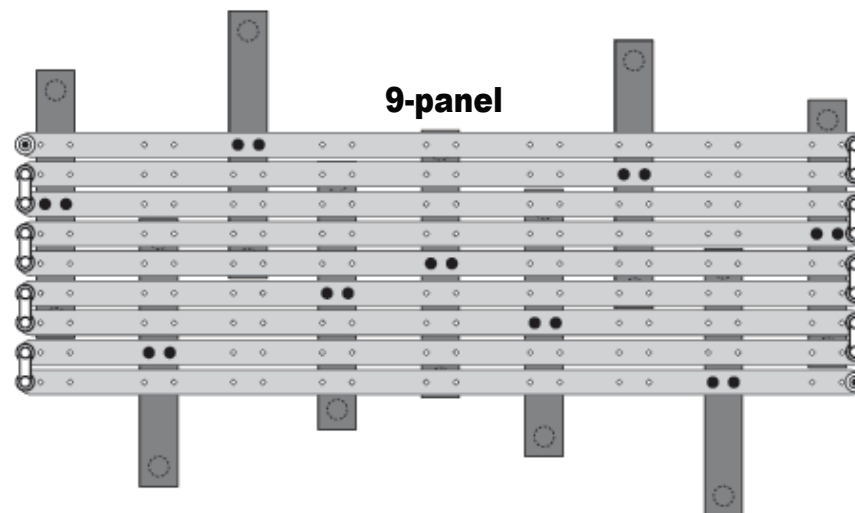
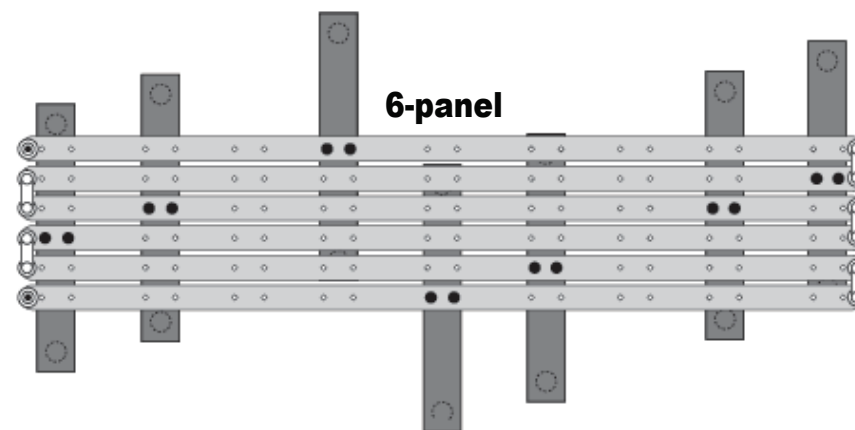
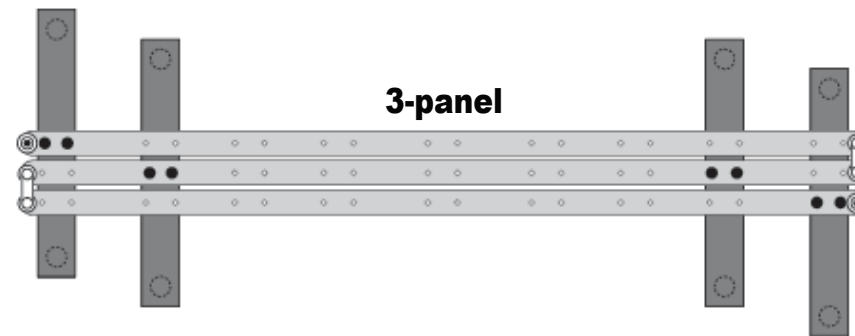
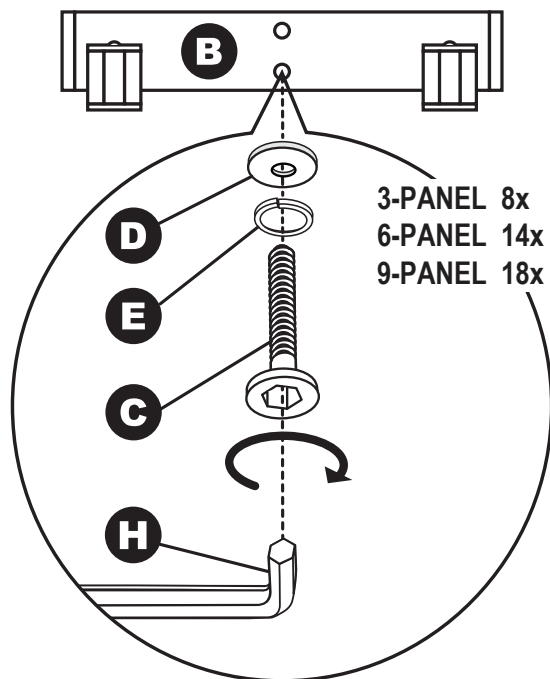

OPTIONAL CASTER PLACEMENT FOR 2, 4, 5, 7, 8 PANELS

COLOCACIÓN DE PIVOTE OPCIONAL EN LOS PANELES 2, 4, 5, 7 Y 8

POSSIBILITÉ DE PLACER DES ROULETTES POUR 2, 4, 5, 7, 8 PANNEAUX

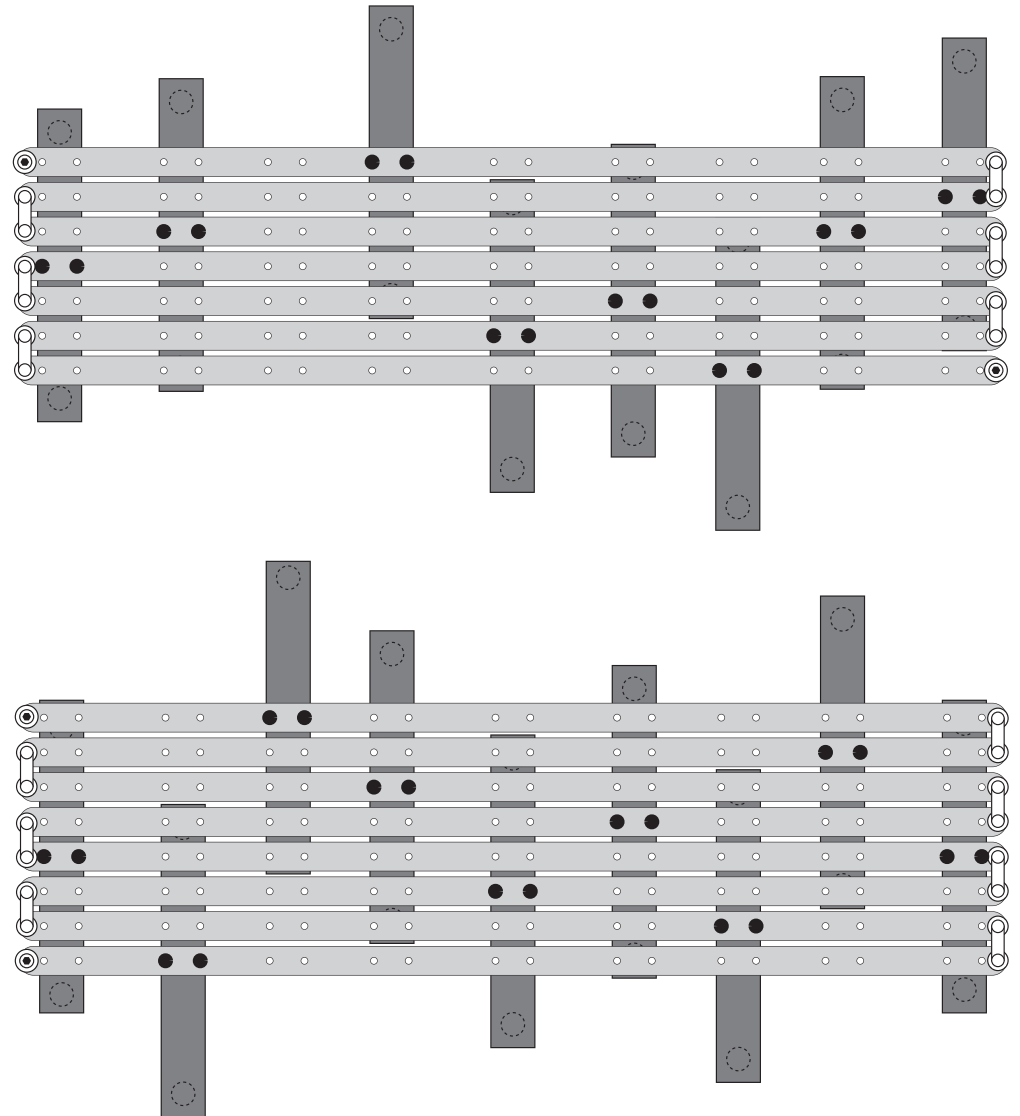
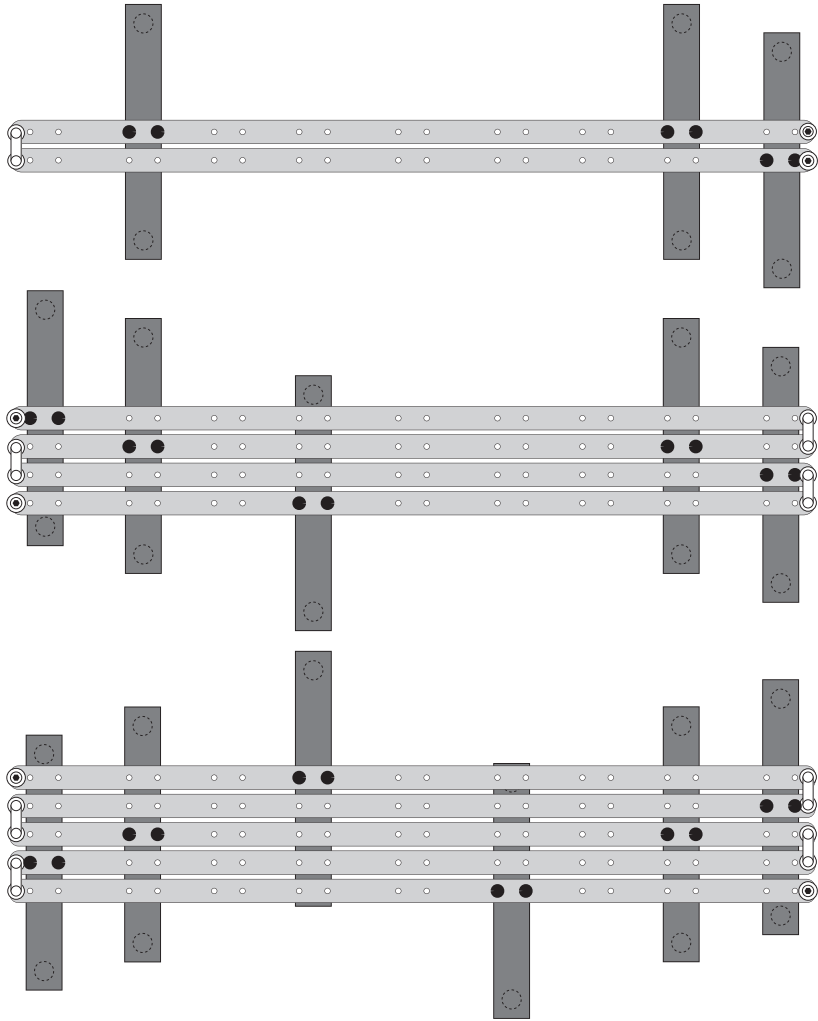

⚠ WARNING:

Choking Hazard – Small parts. Not for children under 3 years.

Adult Assembly Required.

Two adults recommended.

- ▲ Contains small parts, sharp points and edges.
- ▲ Do not stand, sit, kneel, climb, lean or pull on unit for support.
- ▲ Never leave children unattended.
- ▲ Do not place unit near high heat or moisture.
- ▲ Adult supervision recommended.
- ▲ Periodically check and tighten screws.

⚠ ADVERTENCIA:

Peligro de asfixia – Partes pequeñas. No apto para niños menores de 3 años.

Se requiere un adulto para su ensamblaje.

Se recomienda que lo hagan dos adultos.

- ▲ Contiene partes pequeñas, puntas y bordes filosos.
- ▲ No se pare, siente, arrodille, trepe, recline o jale la unidad como apoyo.
- ▲ Nunca deje a los niños sin atención.
- ▲ No coloque la unidad cerca de donde haya calor o humedad.
- ▲ Se recomienda que lo supervise un adulto.
- ▲ Revise periódicamente y apriete los tornillos.

⚠ AVERTISSEMENT :

Risque d'étouffement - Petites pièces. Ne convient pas aux enfants de moins de 3 ans.

L'assemblage nécessite un adulte.

Deux adultes recommandés.

- ▲ Contient des petites pièces, des parties pointues et des bords tranchants.
- ▲ Ne pas se mettre debout, s'asseoir, s'agenouiller, monter, s'appuyer ou pousser sur l'unité pour se soutenir.
- ▲ Ne jamais laisser les enfants sans surveillance.
- ▲ Ne pas installer l'unité à côté d'une source de chaleur ou d'humidité.
- ▲ La surveillance par un adulte est recommandée.
- ▲ Vérifier et serrer régulièrement les vis.