

ASSEMBLY INSTRUCTIONS

Danbury FC 1Dr

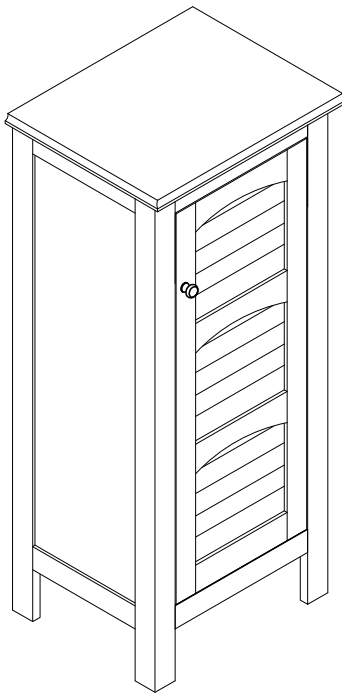

Please provide the following information when contacting for parts or questions: the name of the company you purchased from, the UPS/FedEx tracking number.

This product comes with a 1 year warranty. Products purchased second hand/used are not covered under the warranty.

ASSEMBLY INSTRUCTIONS-IMPORTANT

Carefully unpack & identify each component before attempting to assemble. Refer to parts list. Please take care when assembling the unit and always set the parts on a clean, soft surface. If you require any assistance with assembly, parts, please call the company you place order with or please email to: service@eleganthf.net

INSTRUCCIONES PARA ARMAR-IMPORANT:







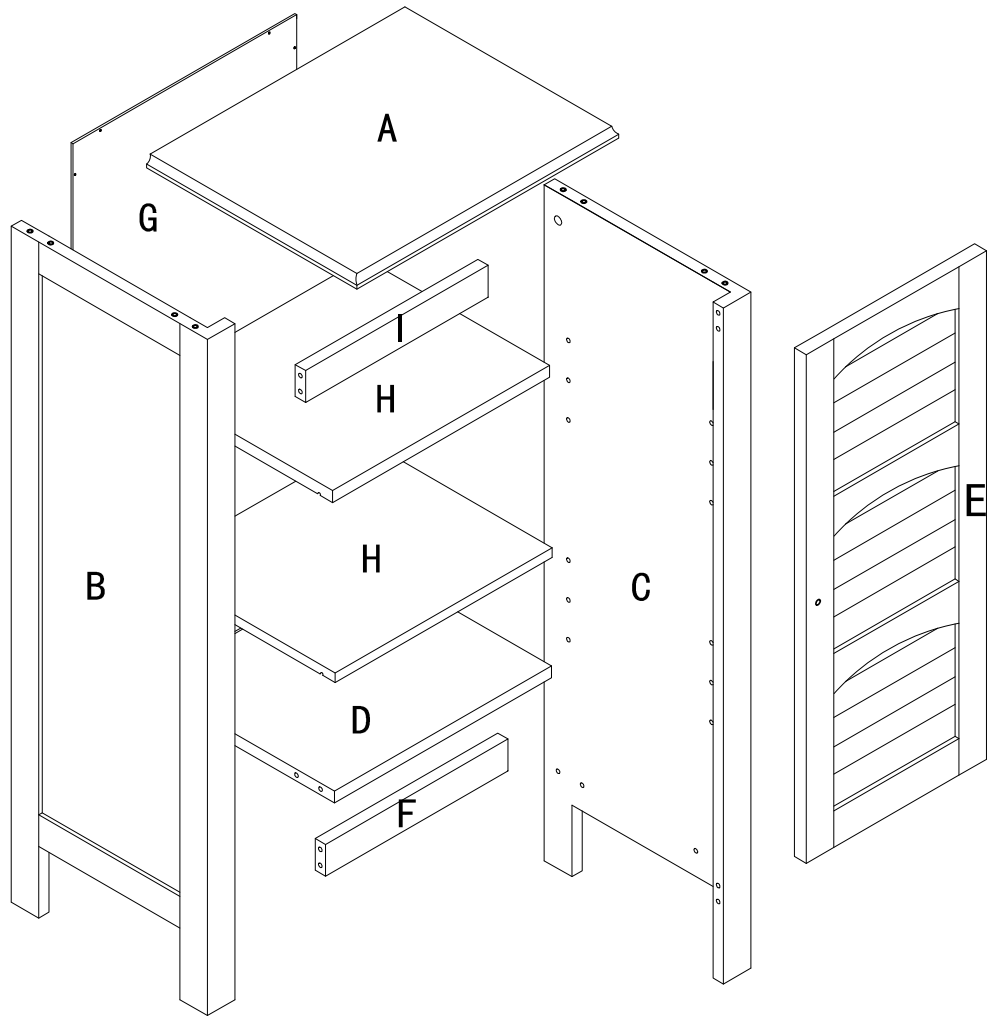

Desempaque cuidadosamente e identifique cada componente antes de tartar de empezar su ensambladura. Verifique la lista de partes. Por favor tenga cuidado cuando arme la unidad y siempre coloque las piezas sobre una superficie plana, suave y limpia. Si necesita ayuda con el armado, envíe un correo electzórico a service@eleganthf.net

DIRECTIVES DE MONTAGE-IMPORTANT:



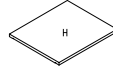







Avant de commencer l' assemblage, déballez délicatement toutes les pièces et repérez-les sur la liste des pièces. Procédez avec soins durant l' assemblage et posez toujours les pièces sur une surface proper, douce et lisse. sie vouo plait e-mail á service@eleganthf.net

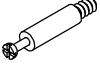

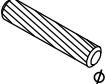
COMPONENTS

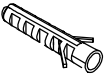
PART	FIGURE	DESCRIPTION	QTY	PART	FIGURE	DESCRIPTION	QTY
A		TOP PANEL	1PC	F		BOTTOM RAIL	1PC
B		LEFT SIDE PANEL	1PC	G		BACK PANEL	1PC
C		RIGHT SIDE PANEL	1PC	H		ADJUSTABLE SHELF	2PCS
D		BOTTOM PANEL	1PC	I		UPPER RAIL	1PC
E		DOOR	1PC				

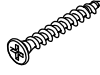
HARDWARE & TOOLS

PART	FIGURE	DESCRIPTION	QTY	PART	FIGURE	DESCRIPTION	QTY
1	 ø15*12	CAM LOCK	8PCS	7		BOLT	1PC
2		CAM BOLT	8PCS	8		SHELF PIN	8PCS
3	 ø8*30	WOODEN DOWEL	16PCS	10	 ø3*12 D=7	SCREW	12PCS
4		ANCHOR	1PC	13		FIX BELT	1PC
5	 ø3*12	SCREW	4PCS	14	 ø4*25	SCREW	2PCS
6		DOOR KNOB	1PC	15		WASHER	2PCS

TOOL NEEDED:



**PHILIPS SCREWDRIVER REQUIRED
- NOT INCLUDED**

SUGGESTION:



TWO PEOPLE FOR ASSEMBLING



WARNINGS:

1. DO NOT LET ANY SHARP OBJECTS TOUCH OR RUB THE SURFACE OF THE PRODUCT.
2. WHEN ASSEMBLING, DO NOT LET CHILDREN PLAY AROUND THE WORKING AREA.
3. PLEASE CONFIRM ALL PARTS ARE CORRECT BEFORE STARTING THE ASSEMBLY PROCESS.
4. DO NOT TIGHTEN ALL BOLTS AND SCREWS COMPLETELY UNTIL THE ENTIRE UNIT HAS BEEN ASSEMBLED AND SET UP.

1

1
4 PCS $\phi 15 \times 12$

2
4 PCS

3
12 PCS $\phi 8 \times 30$

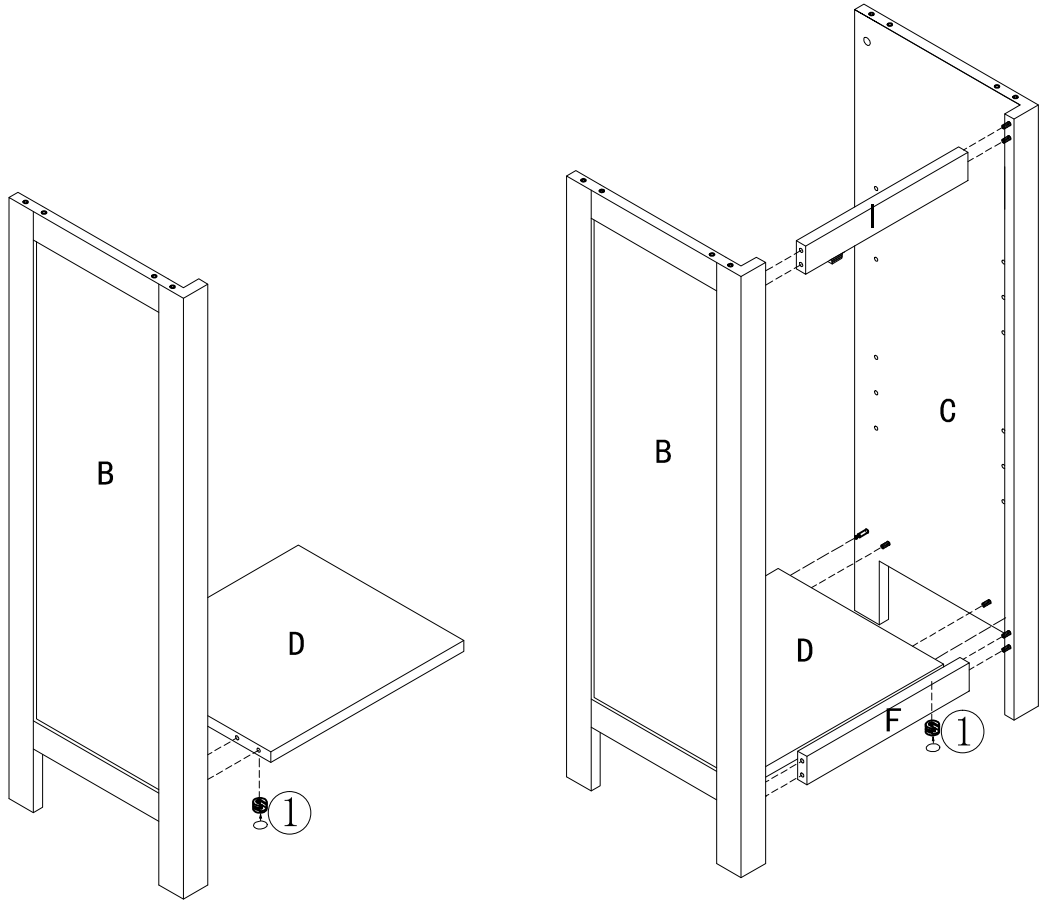
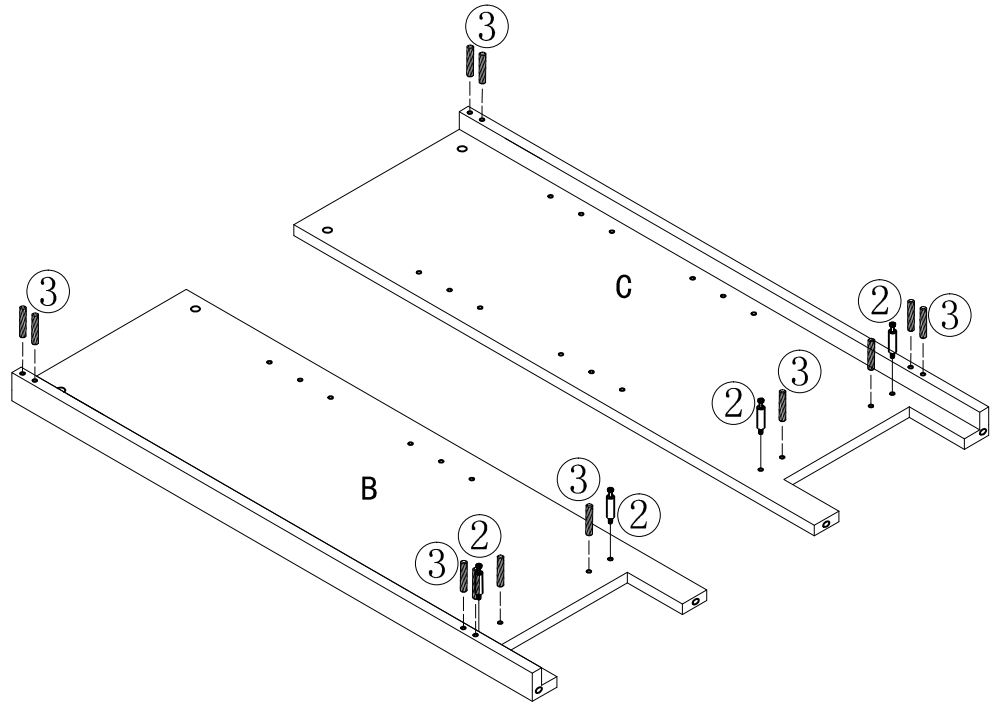

STEP 1:

1. Screw cambolts (2) and insert dowels (3) to panel B & C.
2. Attach panel D to panel B and secure with camlocks (1).
3. Attach rail I, F & panel C to panel B & D and secure with camlocks (1) as indicated.

2

1
4 PCS $\phi 15*12$

2
4 PCS

3
4 PCS $\phi 8*30$

10
12 PCS $\phi 3*12$ D=7

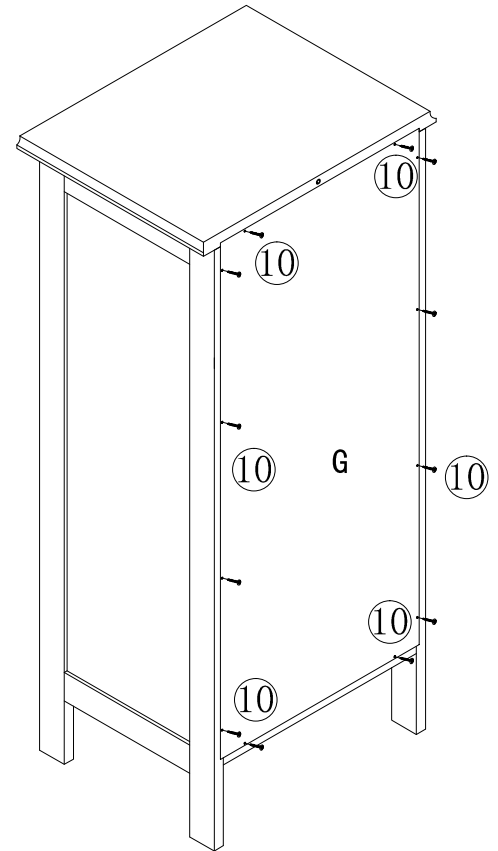
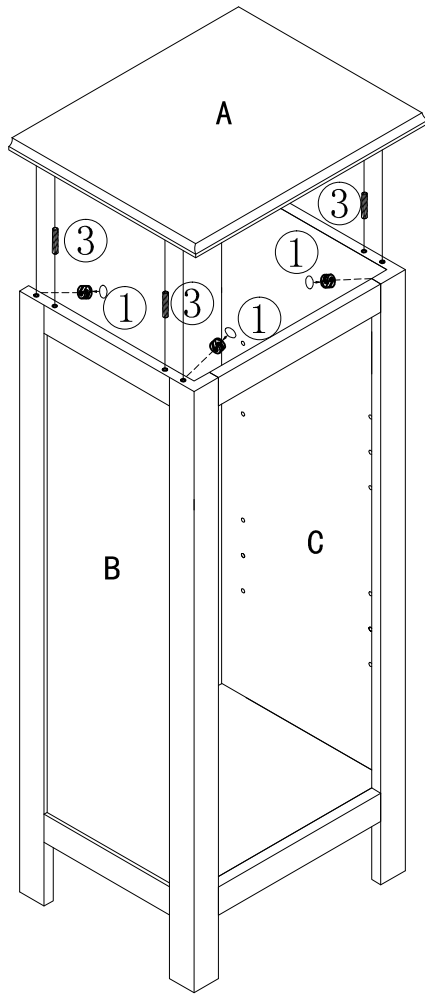
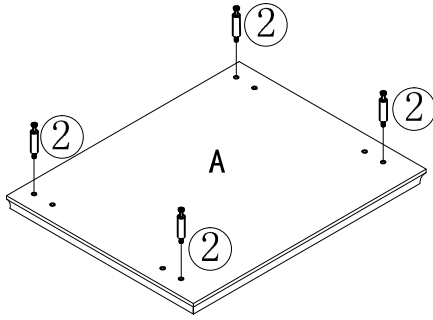

STEP 2:

- 1.Screw cambolts (2) to panel A.
- 2.Insert dowels (3) to the tops of panels B & C, then attach panel A to panels B & C and secure with camlocks (1).
- 3.Attach panel G to the back of the cabinet & secure with screws (10).

3

5



4 PCS $\varnothing 3 \times 12$

6



1 PC

7



1 PC

8



8 PCS

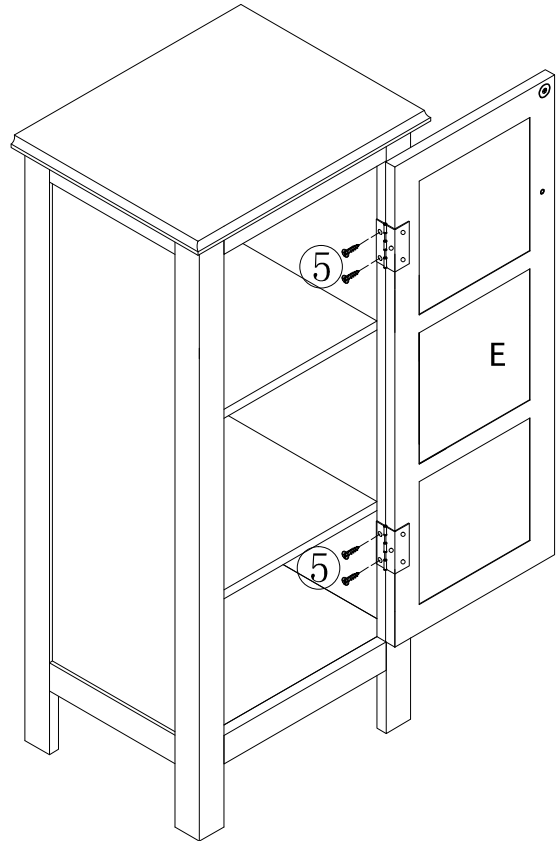
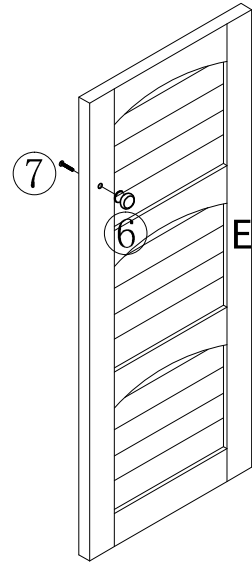
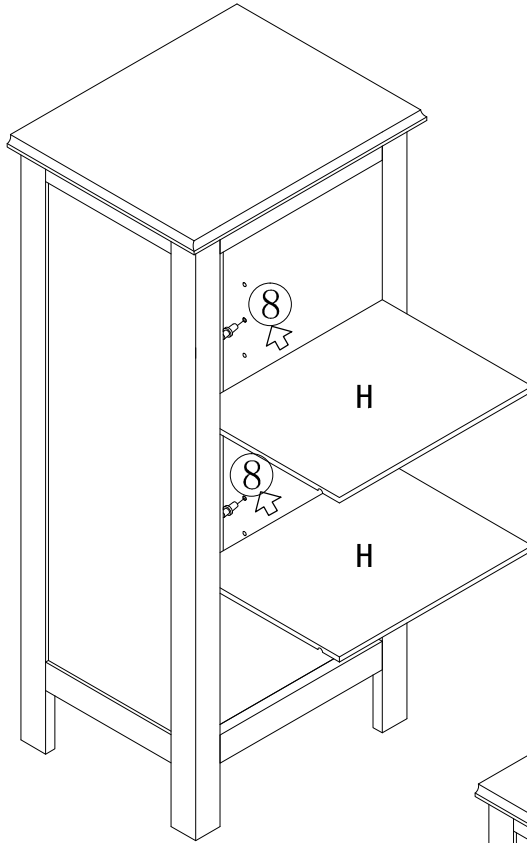

STEP 3:

1. Insert shelf pins (8) in panels B & C and rest the adjustable shelf H on the shelf pins.
2. Attach knob (6) to door E with bolt (7).
3. Attach door E to panel C with screws (5).

4

4



1 PC

13



1 PC

14



2 PCS $\phi 4*25$

15



2 PCS

