

88 5518 30

French Countryside Dining Table

IMPORTANT NOTE

Carefully remove all the parts from the carton and put them individually on a soft cloth to prevent scratches or other damages occurring to the parts.

We have taken great care in the design of this product and request that you carefully and strictly follow our assembly instructions to ensure a completed product as it was designed.

Home Styles

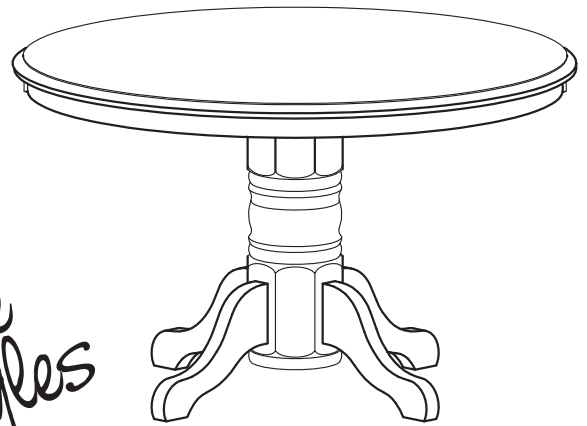

PART LIST

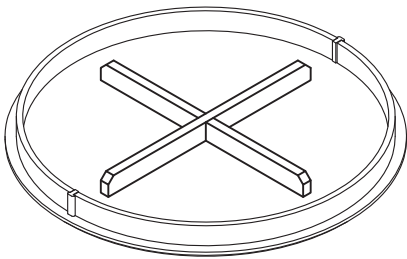

A.
Table Top
1 pc.

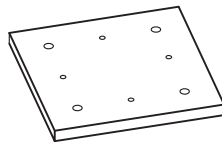

B.
Connector Panel
1 pc.

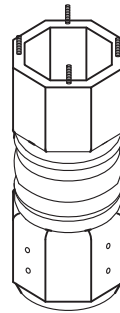

C.
Post
1 pc.



D.
Leg
4 pcs.

HARDWARE LIST



Key Wrench
1 pc.

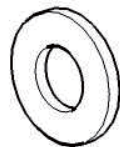

Flat Washer
16 pcs. (+ 1 extra)



Nut
12 pcs. (+1 extra)



Hex Wrench
1 pc.



Small Hex Wrench
1 pc.



Spring Washer
16 pcs. (+1 extra)

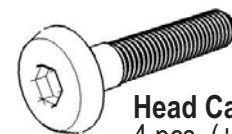

Head Cap Bolt
4 pcs. (+1 extra)

Tools recommended for assembly :Level

Home Styles Consumer Assistance Line 888-680-7460 and 877-831-0319
servicedesk@homestyles-furniture.com

Assembly Instructions

IMPORTANT

- * You should keep Hex Wrench in a safe place as you may need to tighten up the Head Cap Bolts in the future.
- * After assembly item must be level to work properly. Use the included adjustable levelers to level.

STEP 1

Attach Connect Panel (B) to Post (C), using Flat Washers, Spring Washers and Nuts.

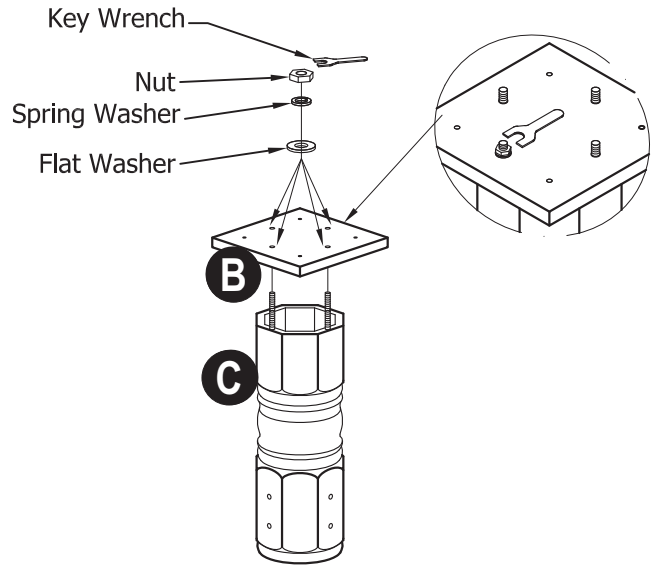
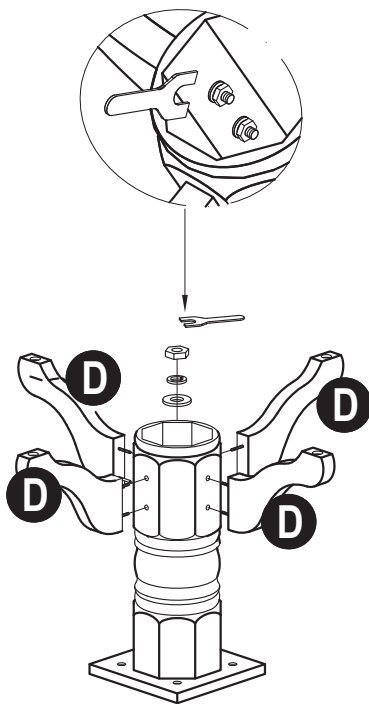

STEP 2

Turn the unit upside down on the soft cloth.

Attach Table Leg (D) to the unit, using Flat Washers, Spring Washers and Nuts.

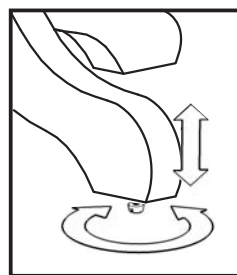

(Figure 1)

STEP 3

Place the Base Unit in Step 2 on to Table Top (A) with Flat Washers, Spring Washers and Head Cap Bolts.

Turn the assembled unit to its upright position.

To level the unit, adjust the adjustable levelers on the bottom of unit. (see Figure 1)

