

INSTALLING PERMANENT STRING LIGHTS

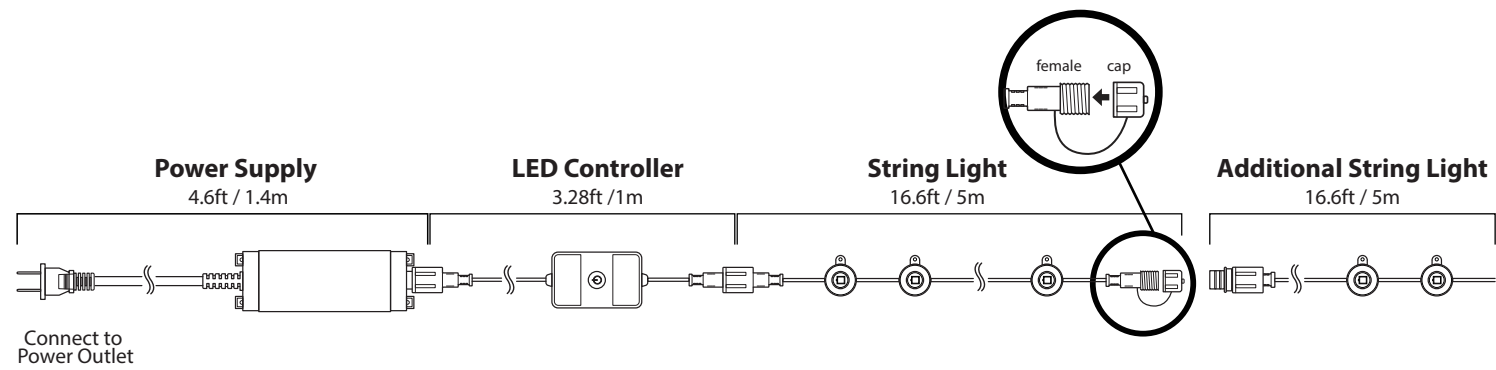

NOTE: WHEN NOT IN USE, ENSURE THE FEMALE END CAP IS COMPLETELY SCREWED IN.

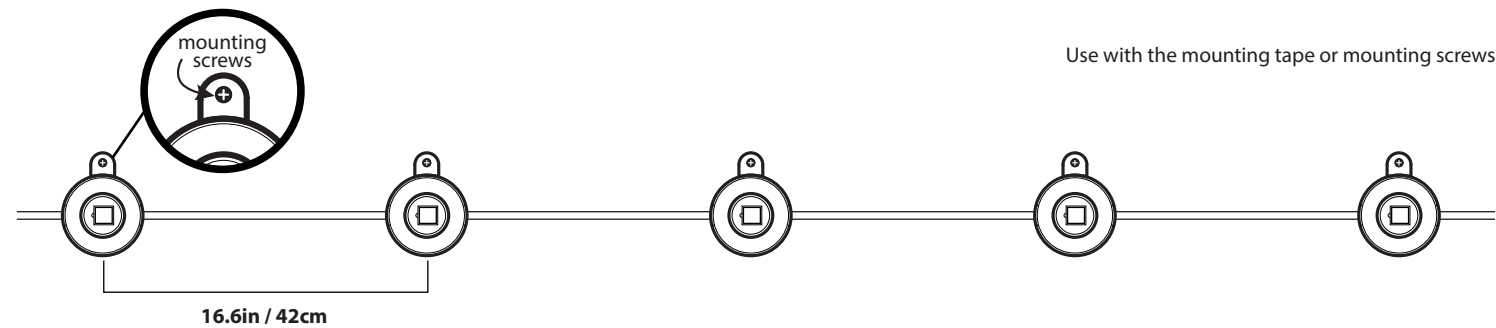

NOTE: DO NOT OVERTIGHTEN THE SCREW.

NOTE: IT IS RECOMMENDED TO MOUNT USING BOTH MOUNTING TAPE AND MOUNTING SCREWS.

NOTE: THESE PERMANENT STRING LIGHTS INCLUDE PERMANENT MOUNTING TAPE AND MAY CAUSE SURFACE DAMAGE IF REMOVED. NOT RECOMMENDED FOR MOUNTING ON BRICK OR CONCRETE. FEIT ELECTRIC IS NOT RESPONSIBLE FOR DAMAGE TO MOUNTED SURFACES.



DRAWINGS NOT TO SCALE.

CONNECTING MULTIPLE SETS

MAXIMUM WATTAGE	STRING LIGHT LENGTH IN BOX	NUMBER OF LIGHT SECTIONS IN BOX	1 LIGHT SECTION	MAX LENGTH
36 WATTS	50 FT	3	9W/16.6FT	DO NOT EXCEED 4 SECTIONS / 66.6FT (EXTENSION SOLD SEPARATELY)

TROUBLESHOOTING TIPS - MOUNTING

1. Replug in the power supply and press the power button to confirm it is turned on.
2. Ensure all connections are properly secured.

MODEL SL50-36/RGB/AG



SMART PERMANENT LED STRING LIGHTS

READ ALL INSTRUCTIONS

WARNING: When using outdoor use portable luminaires, basic safety precautions should always be followed to reduce the risk of fire, electric shock, and personal injury, including the following:

- a. Ground Fault Circuit Interrupter (GFCI) protection is to be provided on the circuit(s) or outlet(s) to be used for the wet location portable luminaire. Receptacles are available having built-in GFCI protection and are able to be used for this measure of safety.
- b. Do not mount or place near gas or electric heaters, fireplace, candles, or other similar sources of heat.
- c. Do not secure the wiring of the product with staples, nails, or place on sharp hooks.
- d. Install only using the mounting means provided.
- e. Do not let lights rest on the supply cord or on any wire.
- f. Do not use this product for other than its intended use.
- g. Do not hang ornaments or other objects from the cord, wire, or lights.
- h. Do not close doors or windows on the product or extension cords as this may damage the wire insulation.
- i. When in use, do not cover the product with cloth, paper, or any material that is not part of the product.
- j. Keep lights away from any combustible surface.
- k. Read and follow all instructions that are on the product or provided with the product.
- l. This product should be installed out of the reach of children.
- m. Do not secure string lights to buildings or other structural supports using nails, staples or other sharp, conducting materials. DO NOT DAMAGE THE WIRE.
- n. Do not submerge.
- o. Use only three-wire outdoor extension cords that have three-prong grounding plugs and grounding receptacles that accept the appliance's plug.
- p. Use only with an extension cord for outdoor use, such as an extension cord of cord type SEW, SEOW, SEOW, SOW, SOOW, STW, STOW, STOOW, SJEW, SJEOW, SJEOW, SJW, SJOW, SJOOW, SJTW, SJTOW, or SJTOOW.



Only supports 2.4GHz Wi-Fi networks



Works with Feit Electric app

Product Specifications:

- 120VAC 36W 50/60Hz
- Dimmable with app
- Suitable for Wet Locations
- IP65 Water Resistant

SAVE THESE INSTRUCTIONS CAUTION:

1. To avoid risk of shock, always make sure the product is unplugged from the electrical outlet before assembling, disassembling, installing, relocating, servicing or cleaning it.
2. Do not overload. This product contains 50FT of string lights, made of three 16.6-foot sections. Each section uses up to 9W. One additional extension of 16.6FT (sold separately) can be added to reach a total of 66.6 feet and use up to 36W.
3. Do not use with extension cord near water or where water may accumulate. Keep at least 4.8 m / 16 ft from pools and spas. Keep plugs and receptacles dry. Do not submerge.
4. Do not exceed the lowest of the indicated maximum wattage on the cord tag near the connected product's receptacle.
5. TO REDUCE THE RISK OF FIRE: Do not replace the attachment plug. It contains a safety device (fuse) that should not be removed. Discard product if the attachment plug is damaged.

Getting Started:

1 Download the Feit Electric app on your smart device



2 Install your Smart Permanent String Lights

See "Installing Permanent String Lights" section on page 4.

3 Plug in your Smart Permanent String Lights

Plug the Smart Permanent String Lights into an outdoor rated GFCI receptacle.

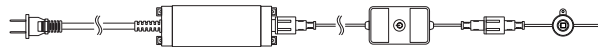

WARNING: These products may represent a possible shock or fire hazard if improperly installed or attached in any way. Products should be installed in accordance with the owners manual, current electrical codes and/or the current National Electric Code (NEC).

To activate smart features proceed to steps 4 & 5.

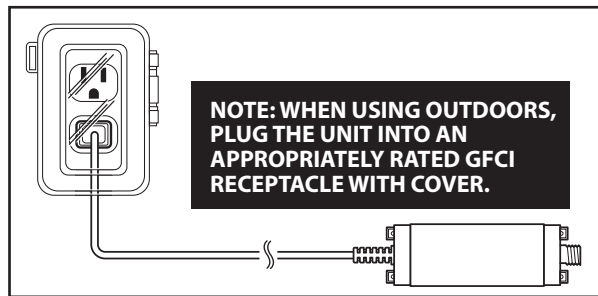

Need Help?

Thank you for your purchase
Questions, comments or feedback?
We'd love to hear from you.
Visit feit.com/help for support or connect with us:



@FeitElectric @FeitElectricInc feitelectricleighting

4 Pair your device

Press and hold for 5 seconds when lights are On to enter pairing mode. Lights will blink.

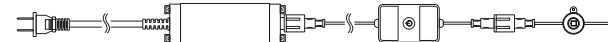

5 Launch and use the Feit Electric app to complete the setup

Tap **Add Device** or the + sign, then select **Chasing Lights** and confirm. You will be prompted to enter your Wi-Fi network and password.

Be sure to connect to a 2.4 GHz Wi-Fi network that covers your installation location.

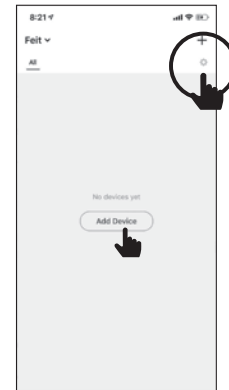

(Optional) Connect to Google Assistant or Alexa using the in App guide

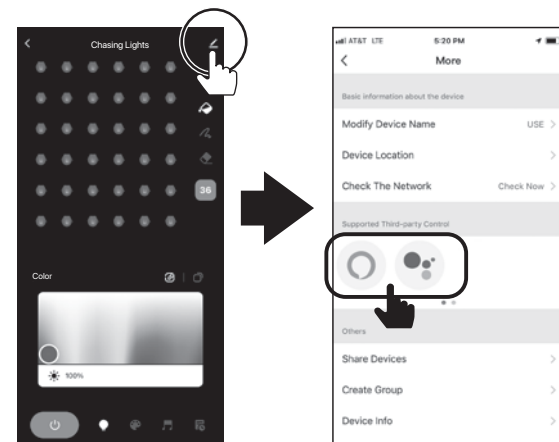

Tap Pen icon

Choose **Alexa** or **Google**

Power Supply and LED Controller

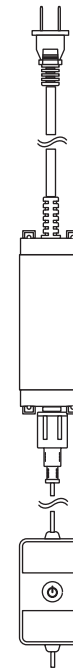

8 MODES:

1. Party
2. Red
3. Green
4. Blue
5. White
6. Fade
7. Chasing
8. Flow

Press power button once to turn on and twice to turn off.
Press and release to cycle through 8 different colors, themes or modes.
Press and hold for 5 seconds or until bulbs start to blink to enter pairing mode or to reset.

TROUBLESHOOTING TIPS - WI-FI

If you are having difficulty connecting:

- Make sure the Wi-Fi network is a 2.4 GHz network. Smart Permanent String Lights will not connect to a 5 GHz network.
- Test your Wi-Fi network with other devices such as your phone to make sure it is operating properly.
- The Wi-Fi connection may not have good coverage during set up. Try moving the Smart Permanent String Lights closer to your Wi-Fi router.
- Your Wi-Fi network password is case sensitive, make sure you are entering correctly. Devices plugged into your Smart Wi-Fi Plug must be ON in order to be controlled via the mobile app.

Please also check the App User Guide for more information.

LIMITED WARRANTY

This product is warranted to be free from defects in workmanship and materials for up to 1 year from date of purchase. If the product fails within the warranty period, please visit feit.com/help for help. REPLACEMENT OR REFUND IS YOUR SOLE REMEDY. EXCEPT TO THE EXTENT PROHIBITED BY APPLICABLE LAW, ANY IMPLIED WARRANTIES ARE LIMITED IN DURATION TO THE DURATION OF THIS WARRANTY. LIABILITY FOR INCIDENTAL OR CONSEQUENTIAL DAMAGES IS HEREBY EXPRESSLY EXCLUDED. Some states and provinces do not allow the exclusion of incidental or consequential damages, so the above limitation or exclusion may not apply to you. This warranty gives you specific legal rights, and you may also have other rights which vary from state to state or province to province.



Supplier's Declaration of Conformity:

47 CFR § 2.1077 Compliance Information

Responsible Party:

Feit Electric Company, 4901 Gregg Road,
Pico Rivera, CA 90660, USA 562-463-2852

Unique Identifier: SL50-36/RGB/AG

This device complies with part 15 of the FCC Rules. Operation is subject to the following two conditions: (1) This device may not cause harmful interference, and (2) this device must accept any interference received, including interference that may cause undesired operation.

This equipment has been tested and found to comply with the limits for a Class B digital device, pursuant to part 15 of the FCC Rules. These limits are designed to provide reasonable protection against harmful interference in a residential installation. This equipment generates, uses and can radiate radio frequency energy and, if not installed and used in accordance with the instructions, may cause harmful interference to radio communications. However, there is no guarantee that interference will not occur in a particular installation. If this equipment does cause harmful interference to radio or television reception, which can be determined by turning the equipment off and on, the user is encouraged to try to correct the interference by one or more of the following measures: Reorient or relocate the receiving antenna. Increase the separation between the equipment and receiver. Connect the equipment into an outlet on a circuit different from that to which the receiver is connected. Consult the dealer or an experienced radio/TV technician for help. Any changes or modifications not expressly approved by the manufacturer could void the user's authority to operate the equipment.

Radiation Exposure Statement

This device complies with FCC radiation exposure limits set forth for an uncontrolled environment. This device should be installed and operated with a minimum distance of 20cm between the radiator and your body.

The performance specifications (life hours) printed on this manual should only be considered an approximation of expected performance.