



Thank you for purchasing Leick Furniture products.
Contact customer service for comments or concerns.

Sheboygan, WI







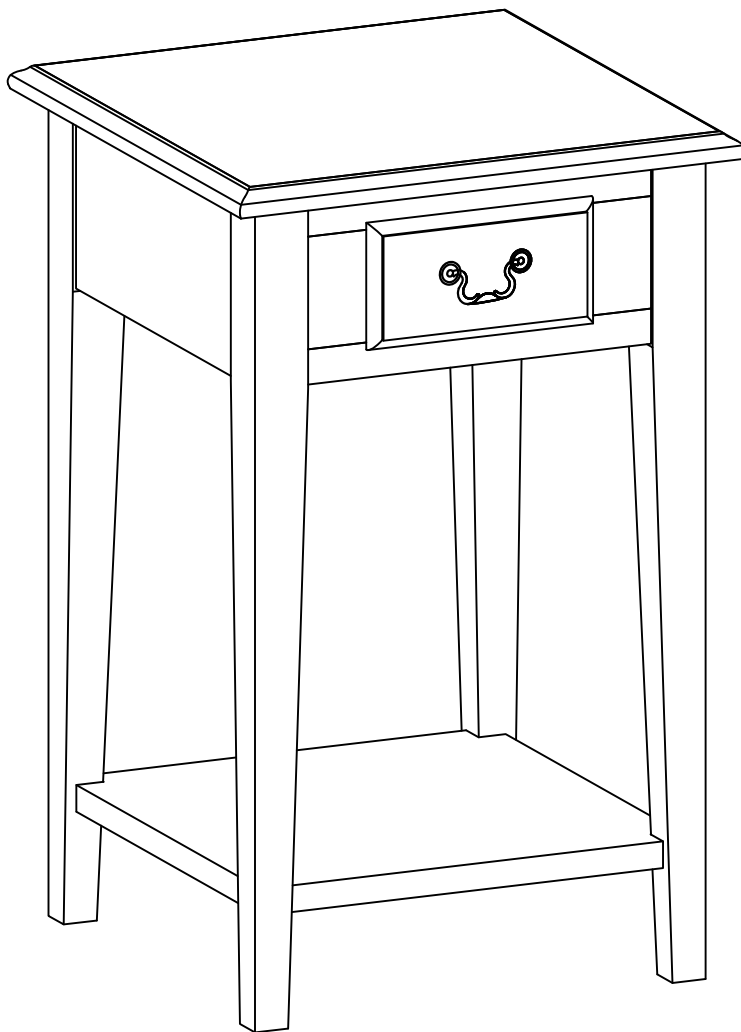

920-451-4060

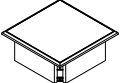
info@leickfurnituresince1910.com

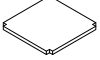
www.leickfurnituresince1910.com

Assembly Instructions, #9041 Square Side Table



A: Top Assembly	
B: (4) Legs	
C: Shelf	
D: (8) Bolts	
E: (8) Flat Washers	
F: (8) Lock Washers	
G: Allen Wrench	
H: (4) Shelf Supports	
I: (2) Extra Drawer Glides	

Step 1

Place the top assembly (A) up side down on a soft surface and then open the drawer.

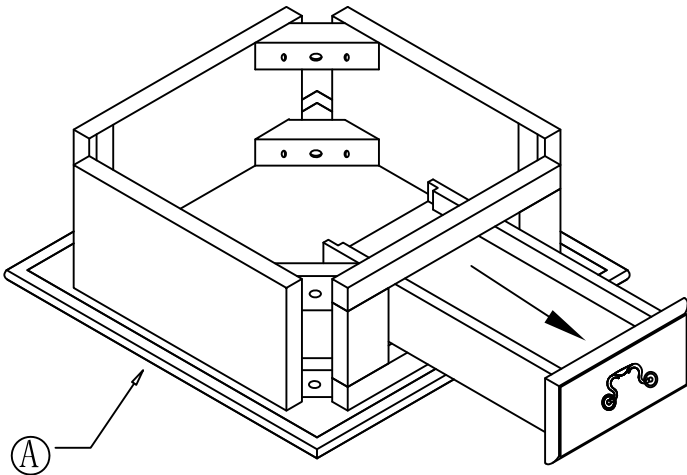

Step 2

Fasten the legs with (8) bolts, flat washers (E), and lock washers (F), using the Allen wrench (G). Tighten.

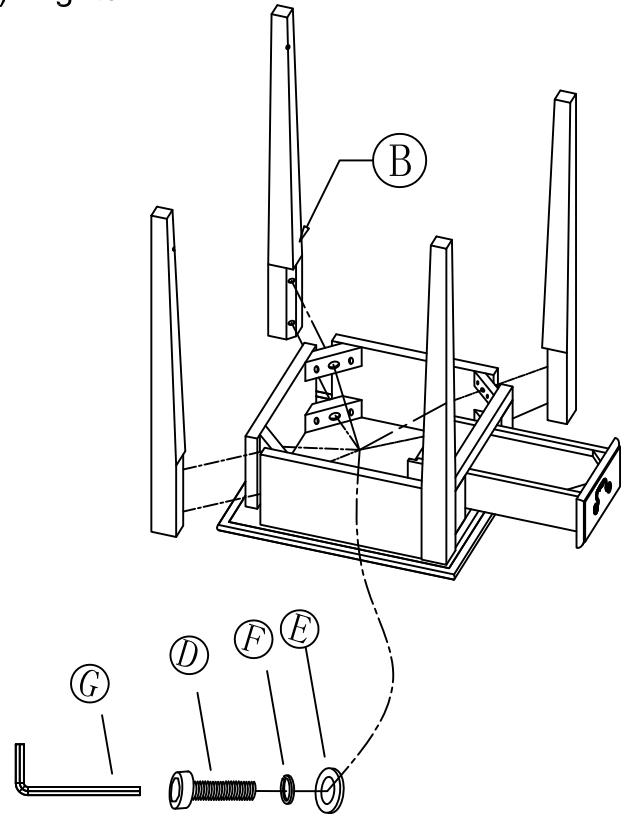

Step 3

Put the shelf upside down on legs until below the leg shelf holes.

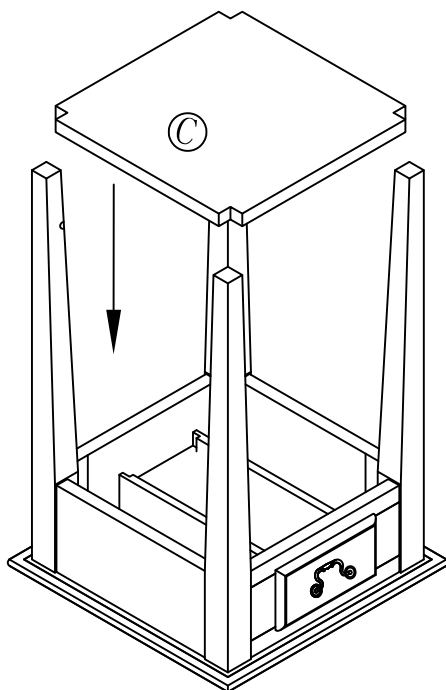

Step 4

Insert the shelf supports into the holes.

