CONTENTS

CATALOG

Warmly Suggestion.....	04
FEATURES.....	05
1.Front Panel Function Instruction.....	06
2.Panel button control instruction.....	07
3.Remote Control Function.....	09
4.Main menu touch operation.....	11
5.SETUP FUNCTION OPERATION.....	12
6. RDS touch operation.....	15
7.DISC PLAY TOUCH OPERATION.....	17
8.DVD function operation.....	20
9.VCD/MPEG-4 function operation.....	23
10.CD function operation.....	26
11.MP3/USB/SD card operation.....	28
12.Other Play Mode.....	29
13. Trouble Shooting.....	30
14.Wiring Diagram.....	31
15.Specifications.....	32
16.Accessory.....	33
17.Setup Need Password.....	33

WELCOME

Thank you for enjoying our series of digital car A/V product. To properly use this product, please go through this instruction manual for installation and operation, put it in a safe place for future use!

WARNING

1. Please keep the disc slot clean, wipe it off when there is some dirt on it. You should wipe off any dirt on the disc before you place it into the unit. If the disc is dirty and you place it inside the unit, it will cause the unit to go into an error and will not play the disc. Please ask professional to clean the laser.
2. Playing the radio at higher volumes for a long period of time may cause hearing issues. You should play this unit at a moderate listen level.
3. This unit is set up by precision parts. If you open up this unit, you will void any and all of your warranty.
4. Please do not touch LCD display with any hard object so that you prevent it from getting scratched or damaged.
5. To avoid an accident caused by watching the LCD screen. This unit has a vehicle lock out wire so that you will not be allowed to watch a video while driving down the road.
6. This unit is meant for a 12V power and negative ground system from a vehicle.

NOTE:

We keep improving this product all the time. There may be some changes in it that are not in this manual.

16.ACCESSORY

Accessory	Quantity
User Manual	1PC
Wire	1PC
USB Cable	1PC
Remote controller	1PC
Warranty card	2PCS

17.SETUP NEED PASSWORD

Setup need password

- ★ During actual operation, when you enter TV setup, system setup, radio area and touch calibration, you need to enter the password "888888".
- ★ DVD Parental control function: The default set for DVD is #8 adult, which means all grades of DVD can be read without entering password. To change the default grade, you need to follow the below procedure: Press SETUP button on the remote, display will show the system set up menu and the submenu, select password and enter 0000, you will be able to choose the DVD grade as default.

15.SPECIFICATIONS:

Power supply DC 12V
Power range 10.8-16.0V DC
Max operate current 10A
Dimensions 155X182X53MM
Ground system Negative ground
Amp Rating 85 Watts x 4 Channels

FM tuner

European frequency range 87.5-108MHz
USA frequency range 87.5-107.9MHz
Signal/Noise ratio 55dB
Stereo separation 30dB
Search station volt 20-30dBuv
Distortion rate 1.5%

AM tuner

European frequency range 522-1620KHz
USA frequency range 530-1710KHz
Limit noise sensitivity 32dB

DVD PLAYER

Signal/Noise ratio 70dB
Frequency response 20Hz-20KHz

FEATURES

DVD PLAYER

- 1.MPEG-4 Decoder Technology
- 2.Compatible with MP4(AVI/5.X),DVD(DVD-R/DVD-RW),VCD,SVCD,CD-RW, WMA,MP3,JPEG
- 3.Supporting Multiles Subtitles,Angles,Languages
- 4.Child lock function
- 5.4-Channel Audio Output
- 6.Pause, play, UP/Down, Stop, Zoom, PBC Function

RADIO

- 1.AM/FM Radio Tuner
- 2.30 Radio Preset Stations (18FM, 12AM)

1. Front panel function instruction

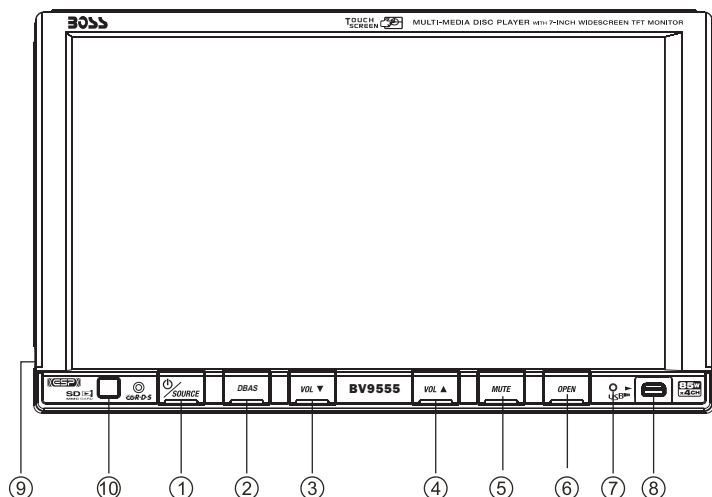

1. SOURCE Button
2. DBAS Button
3. VOL - Button
4. VOL + Button
5. MUTE Button
6. OPEN Button
7. RESET Button
8. USB Slot
9. A/V AUX External Input
10. Remote Control Receiver

14. WIRING DIAGRAM

This player is equipped with ISO standard connector, please follow below instruction:

- Red - ACC ON (+12V)
- Yellow - 12 V Constant
- Black - Ground wire
- Blue - Power Antenna / Remote Amp Turn On
- Orange - Back-Up Camera Trigger (+)
- Grey/Grey black - Right front speaker (+/-)
- White/White black - Left front speaker (+/-)
- Purple/Purple black - Right rear speaker (+/-)
- Green/Green black - Left rear speaker (+/-)
- Pink - Parking Brake (-)

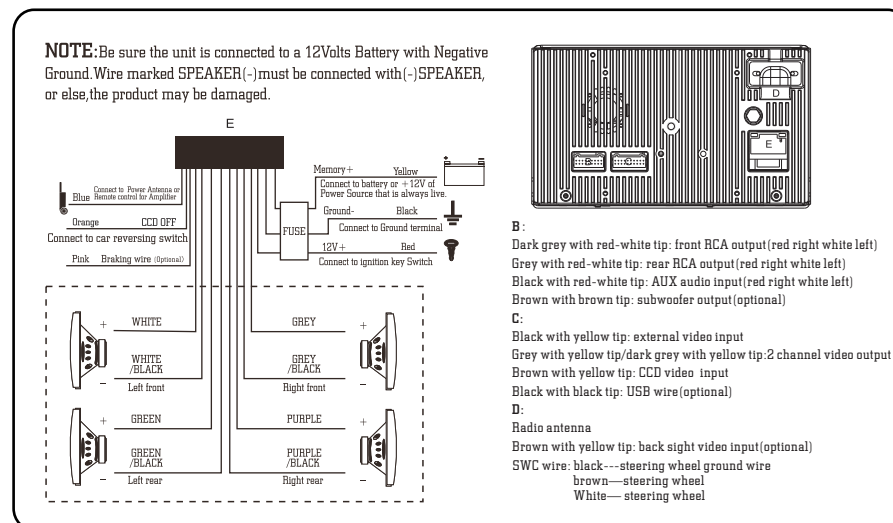

Note:

The “PARKING BRAKE” wire must be connected to the parking brake system of your car. When the parking brake is engages, the LCD will be allowed to view your video. If not, the screen will produce an image saying, “PARKING BRAKE”. This is a safety feature designed for the driver not to watch a video while driving. The video output on this unit will not be affected by this.

13. TROUBLE SHOOTING

PROBLEM	CAUSE	SOLUTION
Can not power on	Check whether power fuse melt or not	Change fuse same as the old one
	Some factor cause MPU wrong operation	Press RESET button on the panel by pen point, then, power on
After ignition switch off, setting information all lose	Wrong connection between ignition line ACC and power line anode pole BAIT	Reconnect line
Remote control no function	No enough power supply from battery	Change battery of remote control
Poor performance of radio station	Improper set of length of antenna, poor connection of antenna grounding	Check whether antenna is connected or not, or poor connection
Can not load disc	There is a disk inside	Eject disk ,then, slot in new disk.
Can not play disc	Disc is scratched	Change new disc
	Put wrong side of disc into unit	Slot in the disk with sign side up
	Lens has dirty	Clean lens by lens clean disc
Can not switch language/subtitle	There is only one language/subtitle in disc	If disk is not with multi-language/subtitle, it cannot switch language/subtitle
No image	Video line between unit and TV is not properly connected	Reconnect lines

2. Panel button control instruction

1. SRC Button

Short press this button to power on . Long press this button to power off .

2. DBAS Button

Press this button to bass on/off.

3. VOL - Button

Press this button to reduce the volume.

4. VOL + Button

Press this button to increase the volume.

5. MUTE / TFT on/off Button

Press this button to shut off the sound output, re-press this button can resume the sound output, long press this button can turn off the TFT LCD display.

6. OPEN Button

Press this button can eject the disc.

7. RESET Button

Press this button and this unit will be restored to the initial state.

8. USB Slot

Connect the USB memory to this socket, and the unit can play music format files supported by this unit in the USB memory.

9. A/V AUX External Input

External connection for A/V input.

10. Remote control receiver

It is able of receiving infrared signals launched by the remote control matching the nuit.

BASE

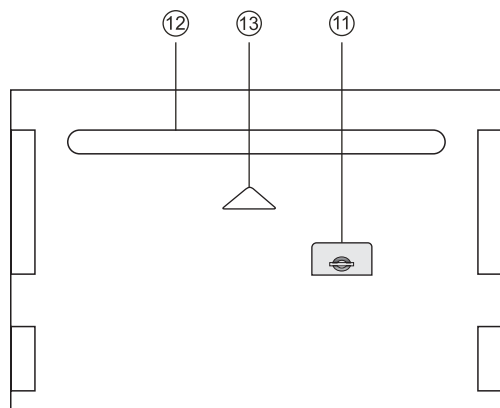

11. SD Slot

12. Disc Slot

13. Slot indicator light

12. Other mode

AUX IN OPERATION

Please link video socket input with AUX video input jack, and link audio input with AUX audio input jack.

This unit has one video input and one pair of audio input.

In main interface, touch  to enter the following interface:

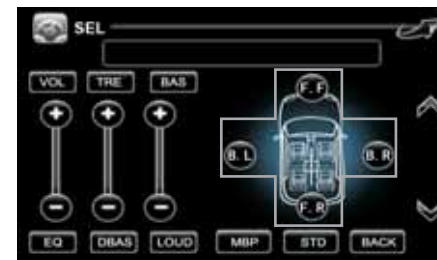

can slide the panel upward or downward

EQ: touch this button to switch mode as follows: POP-ROCK-CLASS-CLOSE

DBAS: click this button to turn on/off subwoofer.

LOUD: click this button to turn on/off LOUD.

MBP: click this button to enjoy the best music effects in different position.

STD: click to resume standard video.

Back: click this button back to previous interface

CCD (back-up camera)

If there is a back-up camera installed into your car, please link the back control line "back" of the unit with camera control port, and link video output with camera video output.

When you are backing up the car, the unit will auto switch to rearview mode. (As the following picture)

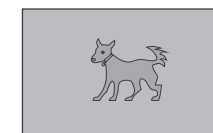
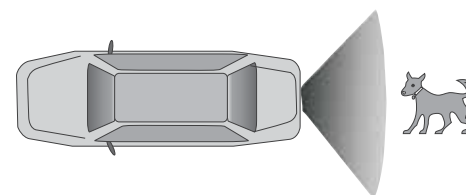

Rearview picture while backing up car

11.MP3/USB/SD card operation





1. Insert SD card or USB, MP3 disc; click the name of the song directly to select the song you want to broadcast. If there are pictures or video document in the disc or SD card, you can select the relative icon to broadcast.

2. Playback MP4 files, the touch screen  into the MP4 format, you can click directly Or through remote control and touch button to choose the direction you need MP4 repertoire.

3. This interface of DVD touch function will display if you click on KFY (Please refer to the instruction of DVD touch function)

NOTE: By a remote control  stop button to return to the playback screen.



(1).Pause play

In playing mode, press  button on remote control, or  touch button on display to pause. Press again to back to normal play.

(2).Previous / next song play

In playing mode, press SEEK + / SEEK - on remote control, or  /  touch button on display to choose next/ previous song.

(3).Speed forward/ backward

In playing mode, long press  /  button to speed forward/backward. Each time press the button , the changing speed of forward/backward as below:

X2 → X4 → X8 → X16 → X20

↑
↓
Play

Note: it also can be worked by the "forward/backward" button on the screen

(4).Repeat play

In playing mode, press AMS/RPT button to execute the following repeat function.

Single repeat → Directory Search → all repeat → repeatedly play off

↑
↓

Note: it also can be worked by the "repeat" button on the screen.

3. REMOTE CONTROL FUNCTION

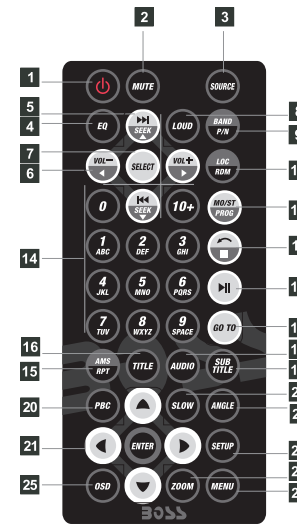

- | | |
|----------------|----------------------|
| 1 POWER ON/OFF | 15 AMS/RPT |
| 2 MUTE | 16 TITLE |
| 3 SOURCE | 17 AUDIO |
| 4 EQ | 18 SET PLAYING TIME |
| 5 SEEK+/SEEK- | 19 SUBTITLE |
| 6 VOL+/VOL- | 20 PBC/MENU |
| 7 SEL | 21 UP/DOWN/L/R ENTER |
| 8 LOUD | 22 SLOW |
| 9 BAND/ P/N | 23 ANGLE |
| 10 LOC / RDM | 24 SET UP |
| 11 STOP | 25 OSD |
| 12 PLAY/PAUSE | 26 ZOOM |
| 13 ST/PROG | 27 MENU |
| 14 0-10+ | |

1. POWER

Press once to switch on, press again to switch off.

2. MUTE Button

Press once to turn off audio output, press again to resume volume level.

3. SOURCE Button

Press this button to choose audio sources.

4. EQ Button

Press this button to choose POP, ROCK, CLASS, EQ off.

5. SEEK + (▶▶) / SEEK - (◀◀) Button

Press this button to manual turning, speed or quick back, previous song and next song.

6. VOL + (→) / VOL - (←) Button

Press this button to increase or decrease volume level.

7. SEL Button

Press this button to choose sound feature.

8. LOUD Button

Press this button to startup LOUD function.

9. BAND - P/N Button

In radio mode, press this button to choose band. In VCD, DVD mode, press this button to choose AUTO, PAL or NTSC system.

10. LOC/RDM Button

In radio mode, press this button to switch between local and direction. In VCD, CD mode, press this key to randomly play.

11. STOP Button

Press this button to stop playing.

12. PLAY/PAUSE Button

Press this button to switch between play and pause. In stop mode, press this button to play.

13. ST/ PROG Button

In radio mode, press this button to choose stereo or mono station. In audio mode, it can help STOP button to programmed play.

14. 0 - 10 + Button

Press this button to choose desired song, section, preset stations.

* Decimal numbers, for example the 19th song, press 1,9 button;

* Centesimal numbers, for example, the 120th song, press 1,2,0 button.

15. AMS / RPT Button

In radio mode, press this button to browse stored stations. In audio mode, press this button to play repeatedly.

16. TITLE Button

In DVD mode, press this button to play back to the top menu of disc.

17. AUDIO Button

In DVD mode, press this button to switch language of dialogue. In VCD mode, press this button to choose left track, right track, and stereo.

18. SET Playing Time

In DVD mode, press this button, you can define playing time.

19. SUBTITLE Button

In DVD mode, press this button to switch language of subtitle.

20. PBC Button

In VCD mode, press this button to display all song menus, work with number button to choose songs.

21. UP, DOWN, LEFT, RIGHT, ENTER Button

In DVD mode, press this button to move cursor up, down, left, right to choose item in menu. Press the enter button to confirm choice.

22. SLOW Button

In audio mode, press this button to slow backward and slow forward.

23. ANGLE Button

In DVD mode, press this button to change play angle.

24. SETUP Button

In audio mode, press this button to choose different set items.

25. OSD Display

Press this button to display the title chapter and the left time.

26. ZOOM Button

In DVD/VCD mode, press this button to ZOOM in.

27. MENU Button

Press button to back to the main menu.

BATTERY CHANGE

When control distance of remote control becomes shorter or no function, please change battery. Please confirm polarity before change.

One hand press stopper, then pull out battery.

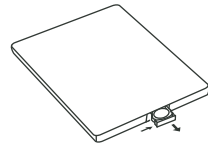

Put battery into controller.

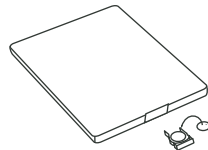

Insert battery holder into controller.

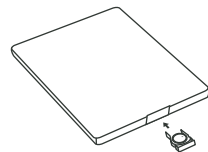

9. Items choose

(1) In playing mode, press the number button on remote control directly to input any item number, the unit will auto play the inputted program.

(2) For above 10 programs, you can via number button 10+ on remote control, work with number button 0--9 to choose.

Note: press the number button 10+ once to be 10+ program, and press 10+button two times to be 20+program, just as follows. It also can be worked by the number button on the screen.

10. CD Program Play

In CD mode, you can set the sequence of playing by the program function, the operation is as follows:

When CD is playing, press ST/PROG button, then the display shows:

PROG	TC	TC	TC	TC			
1	__ : __	5	__ : __	9	__ : __	13	__ : __
2	__ : __	6	__ : __	10	__ : __	14	__ : __
3	__ : __	7	__ : __	11	__ : __	15	__ : __
4	__ : __	8	__ : __	12	__ : __	16	__ : __
			PLAY		DELETE		

Input the number of the song you want to program by the remote control, program the first song, input your desired song, for example, the sixth song, and press number button 6 on the remote control. Program the second song, press ▼ button move the cursor to 2[]. Input your desired song, for example, the ninth song, press number button 9 on the remote control. Press ► button to program play.

Back to the normal mode, press the ST/PROG button, then press ► button.

Note: This function can only be worked by the remote control.

10. CD function operation

1. Disc play

Slot in CD disc, unit will play it automatically. If disk is in slot , touch DVD icon on the main menu can to play.

2. Previous /next song play.

In playing mode, press SEEK-/SEEK+ button on the remote control or "previous/next" button on screen to choose.

3. Speed forward/ backward

In playing mode, long press ►►/◄◄ button to speed forward/backward. Each time press the button , the changing speed of forward/backward as below:

X2→X4→X8→X16→X20
 ↑ Play ↓

Note: it also can be worked by the "forward/backward" button on the screen.

4. Repeat play

In playing mode, press AMS/RPT button to excute the following repeat function.

Single repeat → all repeat → repeatedly play off
 ↑

Note: it also can be worked by the "repeat" button on the screen.

5. Randomly play

In CD playing mode, press RDM button on remote control , the unit will choose any song to play. Please press RDM button again if want to back to the normal play mode.

6. Pause play

In playing mode, press ►|| button on remote control to pause play. . Short press it again to resume the normal play.

Note: it also can be worked by the related button on the screen.

7. Stop play

In CD playing state, first time press ■/) button to enter pre-stop state, and press ►|| button to continue to play. Press ■/) button two times continously to enter stop state completely, while press the play button to start from disc songs.

Note: it also can be worked by the related button on the screen.

8. OSD

In playing mode, press OSD button on remote control to display all the information of the current playing disc.

Note: it also can be worked by the "screen display" button on the screen.

4. Main menu touch operation

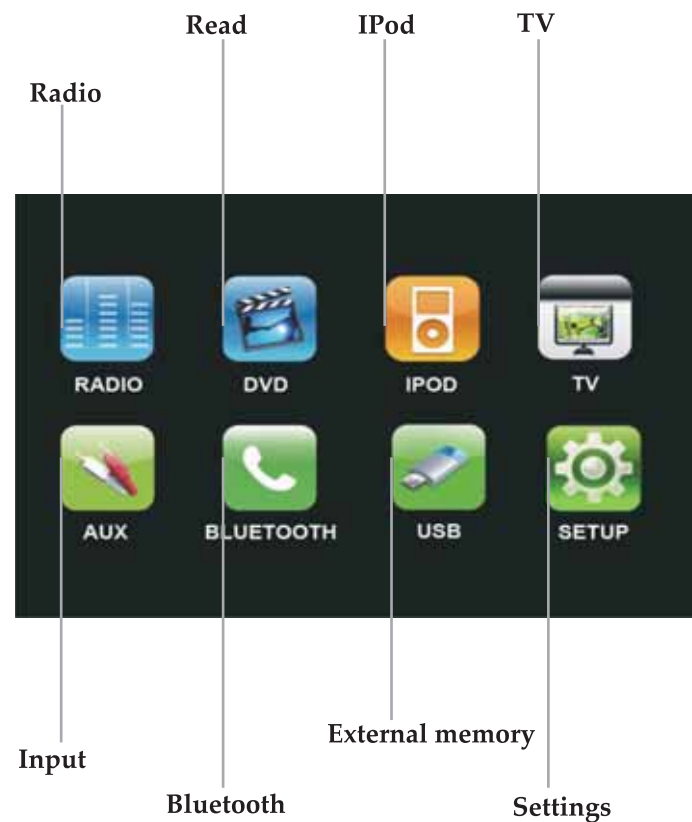

5.SETUP FUNCTION OPERATION

In the main interface, touch  into following interface.

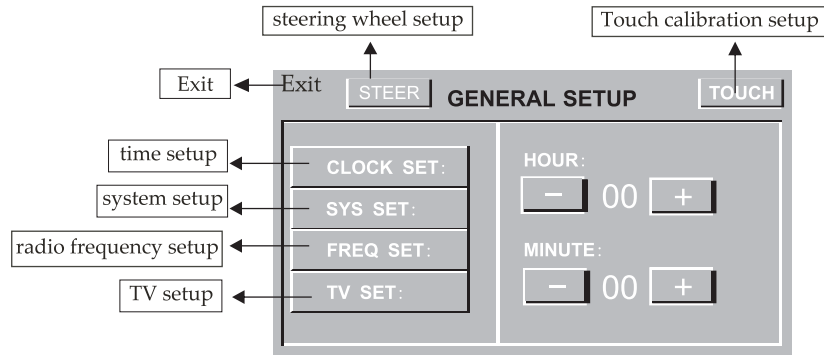

Note: Touch corresponding function, it will display in yellow words reminding, and blue background reminding.

TIME DISPLAY AND ADJUST:Time display: Touch main menu into adjust mode, press time setup button, the corresponding function will be display in yellow words.Press “+” on hour to add hour, press “-” to reduce hour;Press “+” on minute to add minute, press “-” to reduce minute.

NOTE: Touch the correspondence function, will be display in green background. The unit include two times system: Europe time (24 hour setup), America time (12 hour setup), when show the AM mark it indicate morning time, when appear the PM mark, it show the time of afternoon.

System setup:Click this button,then input password"888888".click "ok" into system setup, press relevant button to choose on /off. Press “ok” button to confirm.

radio setup:click "ok" into radio setup. It provides 5 areas (Europe, American 1, American 2, Japan, Russia).

Language setup:Click into choose "Simplified Chinese"/"ENGLISH"

steering wheel setup:click into steering wheel setup.Please refer to (steering wheel function operation instructions)

Touch calibration:



Touch the center of "+" to calibrate screen when the position misgrated.

15. VCD Program Playing

In VCD mode, you can set playing sequence of songs by program play function.

The program playing operation steps are as follows:

In VCD mode, press ST/PROG button, display will show:

PROG	TC	TC	TC	TC			
1	__ : __	5	__ : __	9	__ : __	13	__ : __
2	__ : __	6	__ : __	10	__ : __	14	__ : __
3	__ : __	7	__ : __	11	__ : __	15	__ : __
4	__ : __	8	__ : __	12	__ : __	16	__ : __
		PLAY		DELETE			

Input the songs which you want to programmed by the number buttons on remote control. For example: Program the first song, input your desires song, for example, the fourth song, and press number button 4 on the remote control. Program the second song, press ▼ button move the cursor to 2____. Input your desired song, for example, the eighth song, press number button 8 on the remote control. Press ► button to program play. Back to the normal mode, press the ST/PROG button, then press ► button.

Note: This function can only be worked by the remote control.

9.Slow play

In playing mode , press SLOW button on remote control to slow play , the level of order as below:

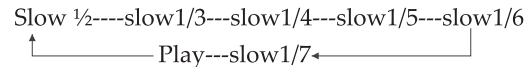

Note: this function can be only worked by the remote control.

10.Zoom in/out picture size

In playing mode, press ZOOM on remote control to zoom in / out picture, the level of size as below:

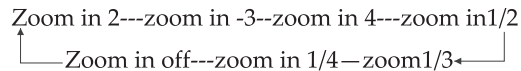

Note: 1. this function also can be worked by the "zoom" button on the screen
 2. move zoomed in picture via up/down/left/right cursor.
 3. zoomed out picture can not be moved .

11.OSD

In playing mode, press OSD button on remote control to display all the information of the current playing disc.

Note: this function also can be worked by the "screen display" button on the screen

12.Items choose

In playing mode, press the number button on remote control directly to input any item number, the unit will auto play the inputted program

For above 10 programs ,you can via number button 10+ on remote control , work with number button 0—9 to choose..

Note: press the number button 10+ once to be 10+ program, and press 10+button two times to be 20+program, just as follows.it also can be worked by the number button on the screen.

13.Sound track switch

In VCD playing mode, play AUDIO button repeatedly to switch the sound track as the following sequence. Touch "AUDIO" button on the display also can realize this function.

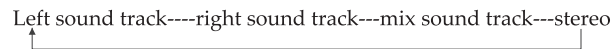

14. PBC (MENU) Play

In VCD mode, press this button then play the PBC and display will show whole menu in disc, work with number button to choose song. When you are playing either song of the PBC, and you want to stop to select another song, press the button to turn off.

Note:

- 1) This function can be worked by the remote control.
- 2) PBC is suitable for the SVCD and VCD 2.0 disc.
- 3) In PBC mode, you can not press number button only to choose song.

Learn steering wheel control operation as follows



1.Pls connect the positive pole/negative pole from origin steering wheel control wire rightly to our unit,power on that unit to that menu as above picture showing,click the setup button.

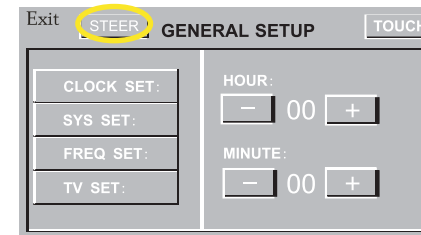

2.After enter into the setup , click " steering wheel" button like as picture show.



3.Enter into steering wheel control setup manu.



4.Make a note for origin car steering wheel control function.

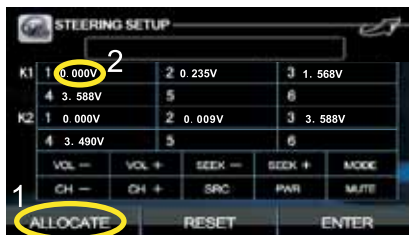

5. (1) Press the button step by step on car steering wheel control and write it down, then click "allocate" button on our unit like as picture show
 (2) Click number "2" to choose that function according to car origin steering wheel control function.

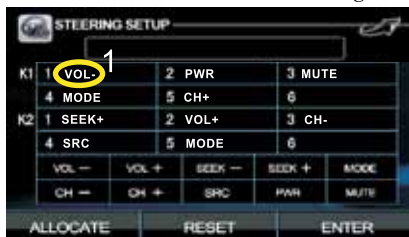

6. (1) As picture indicated, click "voice" in the screen (position 1), then choose the same word in the choose screen.

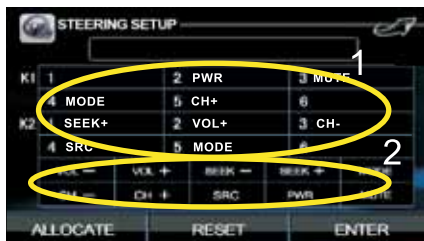

7. Like picture shows, click position 1 to choose what function button you revise, click position 2 to make revise to them.

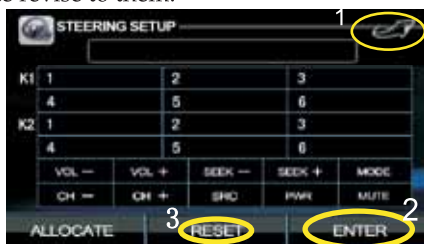

8. (1) Like picture show, click "2" button in order to keep save, click "1" to return
 (2) Click the "2" button in the screen, then finish the setup.
 (3) Click area 3 to delete all steering wheel control, and reset all steering control function under re-do the above mentioned

9. VCD/MPEG-4 function operation

1. Disc play

Slot in VCD/MPEG-4 disc, unit will play it automatically. If disk is in slot, touch DVD icon on the main menu can to play.

2. Previous /next song play

In playing mode, press SEEK-/SEEK+ button on the remote control to choose.

3. Speed forward/ backward

In playing mode, long press ►►/◄◄ button to speed forward/backward. Each time press the button, the changing speed of forward/backward as below:

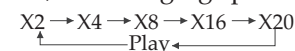

Note: it also can be worked by the "forward/backward" button on the screen.

4. Repeat play

In playing mode, press AMS/RPT button to excute the following repeat function.



Note: In VCD mode, this function can be worked while shut off PBC. it also can be worked by the "repeat" button on the screen

5. Randomly play

In VCD playing mode, press RDM button on remote control, the unit will choose any song to play. Please press RDM button again if want to back to the normal play mode.

- Note:** 1. In VCD mode, this function can be worked while shut off PBC
 2. This function can only be worked by the remote control.

6. Pause play

In playing mode, press ►|| button on remote control to pause play. Short press it again to resume the normal play.

Note: this function also can be worked by the related button on the screen

7. Stop play

In VCD playing state, first time press ■/.) button to enter pre-stop state, and press ►|| button to continue to play. Press ■/.) button two times continuously to enter stop state completely, while press the play button to start from disc songs.

Note: this function also can be worked by the related button on the screen

8. System switch

In playing mode, short press BAND/P/N button on remote control, then the order of system switch as below:



INSTRUCTIONS

14. Angle Switch

If the DVD disc is recorded with multi-angles, you can press the ANGLE button to switch the angle during playing.

The sequence is as follow:

ANGLE 1 → ANGLE 2 → ANGLE 3

Note:

1. It just can be worked by the remote control.
2. It is only for the DVD disc which has multi-angle.
3. If there is a  sign on the cover of the DVD disc. The number in the sign means how many angles the disc has.
4. You can not switch the angle when slow playing.



15. Multi-Audio

There are different languages of dialogue and audio systems in DVD disc.

If the DVD disc is recorded with multi-audio, you can switch the language of dialogue and the audio systems when playing.

Press the AUDIO button repeatedly to change the language of dialogue.

Note



1. It just can be worked by the remote control.
2. It is only for the DVD disc which has multi-language.
3. If there is a  sign on the cover of the DVD disc,  means that it was recorded by multi-language/audio system.

16. Multi-Subtitle



If the DVD disc is recorded with multi-subtitle, you can switch the languages of subtitle.

Press the SUB-T button repeatedly to change the language.

Note:

1. It just can be worked by the remote control.
2. It only for the DVD disc which is recorded with multi-subtitle.
3. If there is a  sign on the cover of the DVD disc  means that it has several subtitle.

17. Setup

Press SETUP button, display will show the system setup menu and the submenu, select the item you want by  , after selecting the proper item, press  to press ENTER to confirm.

Note:

1. It just can be worked by the remote control.
2. Some function setting maybe different because of the different model or disc.
3. If the selected language is not recorded in the disc, then unit will show the appointed language.

6. RDS touch operation

In the main interface , touch  into following "radio" interface.

Pre-store stations operation:

Each band can pre-store 6 stations. You can directly click (P1—P6) to choose in the pre-store stations, and it will display in the screen.

Store stations:

Choose a band and then a station . press longer preset button(p1-p6) to display the number in the screen.



 :Short touch to counter-clockwise adjust FM/AM receive frequency steply; long touch to auto scan FM/AM atations counter-clockwisely.

 :Short touch to clockwise adjust FM/AM receive frequency steply; long touch to auto scan FM/AM atations clockwisely.

 :Click the button to scan preset stations in 1-6button. Press longer to auto search radio stations, and store the strongest stations in the display of number button.

 :click the button into "setup"interface(please refer to "AUX input operation" instructions in "other mode")

 Press PTY, when PTY is on, it means there is strong RDS signals output.

 :click "mute" button to shut off VOL, and click again to resume the original VOL level.

 Press TA, when TA is on, it means the unit is automatically track RDS radio channels.

 Press this button to choose radio channels' name, please refer to details user manual.

 :Click the button to choose band:FM1-FM2-FM3-AM1-AM2

RDS

1. EON (RDS Mark)

Indicate main unit is on auto tracking RDS mode.

2. AF (RDS Auto Tracking Mark)

Indicate radio is auto tracking RDS channel.

3. TA (RDS Signal Increasing Output)

Indicate RDS channel have signal increasing output.

4. TP (RDS Channel Stereo Mark)

Indicate RDS channel is on stereo playing mode.

5. POP.M (RDS Channel Mark)

Indicate RDS channel name.

I. RDS Tracking System

Press AF button in FM mode, and then press ◀▶ last 2 seconds, RDS will auto search channel up and down, it will stop searching when RDS channel be founded, but "AF" will keep remaining on the screen and waits for the next traffic emergency report.

II. RDS Tracking on Playing Mode

In playing mode, "AF" tracking system keeps on opening and waits for traffic emergency report.

1)PTY: RDS button, press once will show music mode POP, press 1-6 function memory button, every group have 2 channel.

POP M ROCK M EASY M
LIGHT M CLASSICS M OTHER M
JAZZ COUNTRY NATION

2)Press PTY button twice and then press 1-6 function memory button, every button have 3 channel.

NEWS AFFAIRS INFORMATION SPORT
EDUCATION DRAMA CULTURE SCIENCE
CHILDREN SOCIETT TELIGION PHONING
TRAVEL

Note: RDS channel in broken line is available.

AF: RDS auto search button, in radio mode also can press this button shortly auto tracking RDS channel, press this button shortly can cancel RDS function.

TA: In RDS mode, press this button can output TA signal, and check RDS channel is exist or not, if no RDS signal TFT will show "NO. TA. TP".

8. Slow Play

Press SLOW button on remote control to slow play. The level of slow playing is as follows. Sequence is :

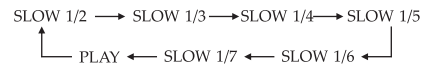

Note: This function can only be worked by the remote control.

9. Zoom In/Zoom Out

Press ZOOM button on remote control to zoom in / zoom out the picture. The levels are as follows:

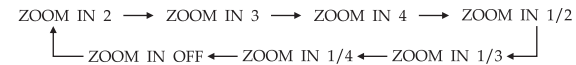

Note:

1. This function can only be worked by the remote control.
2. Image which is zoomed in can be moved by up/down/left/right cursor to move.
3. Image which is zoomed out cannot be moved.

10. OSD

In playing mode, short press OSD on remote control to show all information of present disc.

11. MENU Select

In playing mode, press PBC button on remote control to back to the menu, display will show chapter and section in disc. Work with ▲/▼ button on remote control or touch button on display to choose your desired song. Press ▶ button / ENTER button to play.

12. Title Select

In DVD mode, press TITLE button to back to the title menu. Display shows all the titles of the disc. You can select the chapter you want by the cursor, press play button to play the chapter.

Note: It just can be worked by the remote control.

13. Program Play

In DVD mode, you can set the sequence of playing by the program function, the operation is as follow:

PROG	TC	TC	TC	TC			
1	01:03	5	---	9	---	13	---
2	01:06	6	---	10	---	14	---
3	---	7	---	11	---	15	---
4	---	8	---	12	---	16	---
		PLAY		DELETE			

When DVD is playing, press ST / PROG button, then display shows:

For example, program the first song, input 01, press ▶ button move the cursor to the second lattice, input desired song, for example, the third song. Program the second song, press ▼ button, move the cursor to 2 [] --. input 01, press ▶ button move the cursor to the second lattice, input desired song, for example, the 6th song (press 6). Press ▶ button to program play. Back to the normal mode, press the ST/PROG button, then press ▶ button.

Note: This function can only be worked by the remote control.

8.DVD function operation

DVD play:

Pls slot in DVD disk, the unit will play it automatically. If disc is in slot, touch DVD button on main menu to play disc.

1.Previous /next song play:

In playing mode, press SEEK-/SEEK+ on remote control or press the “previous”/”next”button on the screen.

2.Repeatedly play:

In playing mode , press AMS/RPT button on remote control to start up following repeat function. Repeat(chapter) → Repeat title → All repeat
 ↙ repeat play/off ↘

Note: it also can be worked by the “repeat”button on the screen.

3.Items play:

In playing mode, directly press any program sequence in the number button of remote control, then unit will auto play the input program. For above 10 programs ,you can via number button 10+ on remote control , work with number button 0---9 to choose.

Note: press the number button 10+ once to be 10+ program, and press 10+button two times to be 20+program, just as follows.

Note: it also can be worked by the number button on the screen.

4.Pause play

In playing mode, press ►► button on remote control to pause play. . Short play it again to cancel pause, and resume to normal play.

Note: it also can be worked by the related button on the screen.

5.Stop play

In DVD playing mode , press ■/>)button on remote control to enter into pre-stop state, then press the button ►► to continue to play. Press ■/>) two times continuously to enter into stop completely. Then press play button to play from the first song.

Note: it also can be worked by the related button on the screen.

6.Forward/Backward

In playing mode, press longer ►►/◀◀ button on remote control to forward/backward respectively.Each time press this button, the speed of forward or backward is as follows: X2 →X4 →X8 →X16 →X20
 ↙ Play ↘

Note: it also can be worked by the “forward/backward” button on the screen.

7.Switch system

In playing mode, shortly press the button BAND/P/N to switch system , the sequence is as follows: AUTO → NTSC → PAL

7.DISC PLAY TOUCH OPERATION

When playing disc, touch any position of the screen, it will display the function menu; touch the menu and the operation of relative function will display.

Note: When loading a disc, touch screen function can not be used.

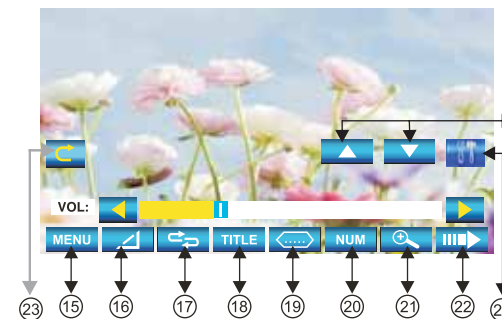
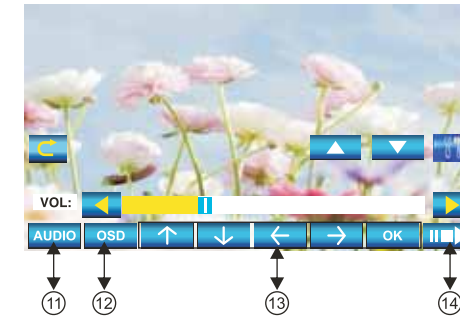
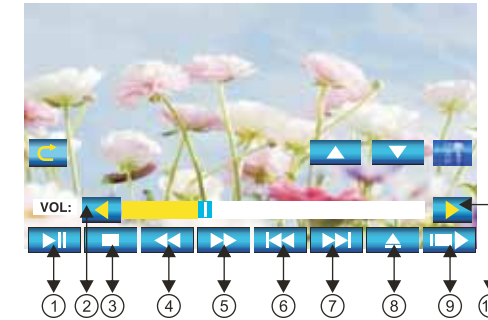

1. Click to choose play/pause
2. Click to reduce the volume
3. Click to stop playing
4. Click to choose the speed of quick back
5. Click to choose the speed speeding play
6. Click to leap backwards to play
7. Click to leap upwards to play
8. Click to exit
9. Click to enter the next page to setup the menu
10. Click to increase the volume
11. Audio
12. Click to display title, chapter, the time already played, the time left
13. At MP3 mode, press this button so you can move the cursor to left/right / up/down and select the songs which in the system menu. then press “OK” button to enter.
14. Click to enter next page set up menu
15. In DVD mode, touch this button to return the directory menu.
16. Click this button to switch to different angles of playing picture in the disc.
17. Repeat play
 DVD: Title Repeat → Chapter Repeat → Repeat play off
 VCD: Single song repeat → Full disc repeat → Repeat play off
 MP3: Single song repeat → Directory repeat → Repeat play off
18. Click on this button to enter title menu
19. Click this button to choose language,
20. click this button and the screen will display 0-10 button.
21. Click this button to Zoom in/Zoom out the picture.
22. Click to enter the menu of operation for touching.
23. Back main menu.



24. Color adjustment

25. Press this button to adjust angles of the monitor

26. Click to select your desired song or chapter

27. Return to the menu one level

Note:

1. When playing VCD, if PBC FUNCTION is on, repeat play is not available.
2. PBC is only suitable for VCD.
3. For VCD disc with play memory, you can use the PBC function;
4. Press PBC in the remote control, Play/Off PBC, press one time to play from the first song;
5. When PBC is on, you can choose speed forward or backward, leap forward or backward, but repeat play is not available.
6. When PBC is on, choose casual play, scan play or search play, PBC function will close automatically.

In DVD interface, touch  button into the audio/video setup interface as following:

(note :the button position will be concave on the screen when you touch it)

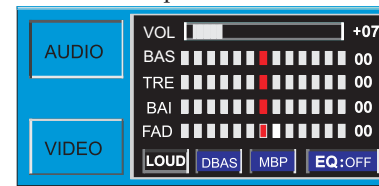

Audio mode

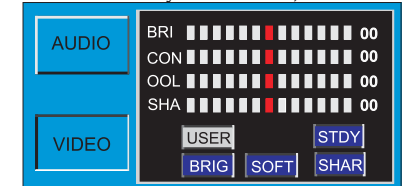

video mode

Volume:click "volume"to turn down sound;click the related character on right to turn up sound.

BASS: click "BASS"to turn down bass effect;click the related character on right to turn up bass effect.

ALT: click "ALT"to turn down alt effect;click the related character on right to turn up alt effect.

L/R: click "L/R"to choose left speaker output,click the number on right to choose the right speaker output .

F/R: click "F/R"to choose front speaker output,click the number on right to choose the rear speaker output.

LOUD:loud on/off.

BASS: bass on/off.

MBP: click this button to enjoy the best music effects in different position.

EQ(on/off):touch to switch modes as follows:POP-ROCK-CLASS-CLOSE.

Brightness:click the left and right edge of the "brightness" strip to adjust the video's brightness.

Contrast: click the left and right edge of the "contrast" strip to adjust the video's contrast.

Color: click the left and right edge of the "color" strip to adjust the video's color.

Sharpness: click the left and right edge of the "sharpness"strip to select the best output effects.

Own setting: click this button to choose your own brightness,contrast, color,sharpness.

Standard:click this button back to the default settings.

BRIG:click this button to increase the brightness,click it again back to the original station.

SOFT:click this button to make the video output soft,click it again back to the original station.

SHAR:click this button to increase the sharpness,click it again back to the original statio.