

# Helix

HEL-SPH180

180 Degree  
Glass-to-Glass  
Pivot Hinge

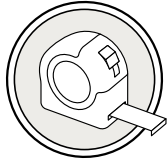

Do not measure images.  
Use specified dimensions.

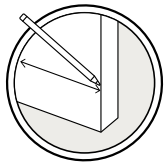

Measure from finished  
edge of glass.

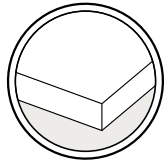

Use monolithic glass.

> **Glass Sizes:**  
5/16" (8mm) to 3/8" (10mm) thick  
tempered safety glass

> **Maximum Door Capacities  
for Two Hinges:**

**Maximum Door Weight:**  
100 lbs. (46 kg)

**Maximum Door Width:**  
31" (787mm)

## Edge Mount Preferred Method 1/8" (3mm) to 3/16" (5mm) Clearance

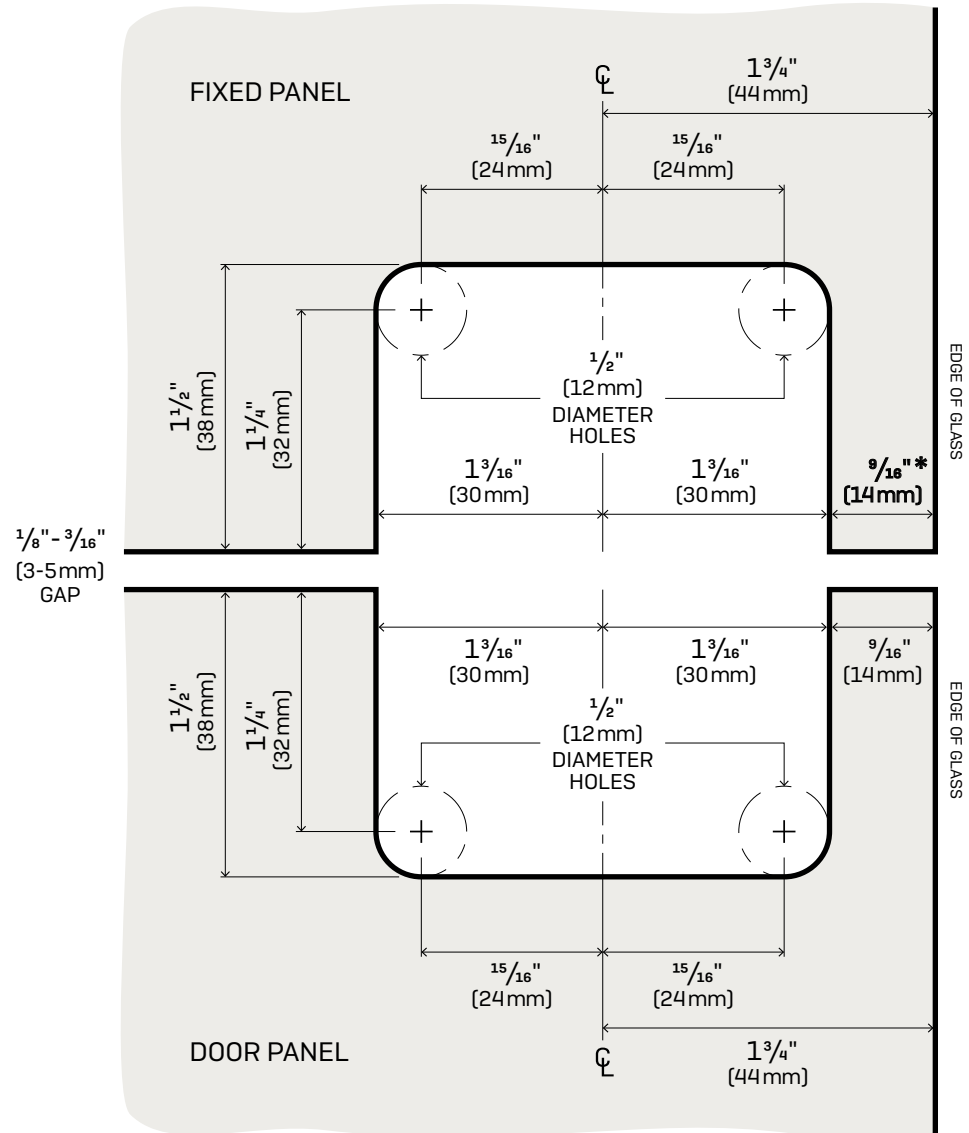
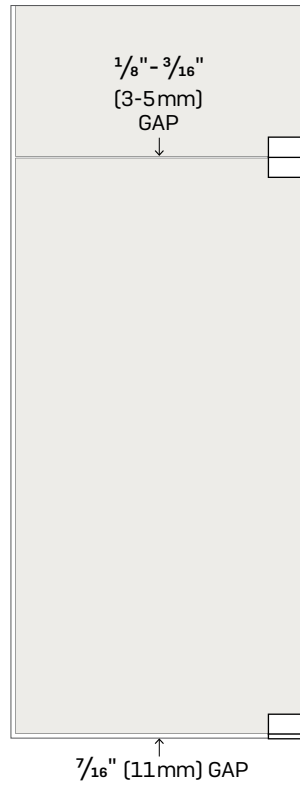

\* The 9/16" (14mm) measurement on the fixed panel outer edge is dependent on the horizontal alignment of the fixed panel being inline with the door panel outer edge. If the fixed panel location is not inline with the door panel, revise this measurement and adjust accordingly.

# Helix

HEL-SPH180

180 Degree  
Glass-to-Glass  
Pivot Hinge

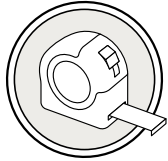

Do not measure images.  
Use specified dimensions.

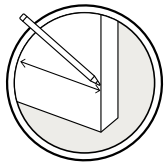

Measure from finished  
edge of glass.

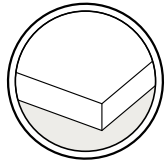

Use monolithic glass.

- > **Glass Sizes:**  
5/16" (8mm) to 3/8" (10mm) thick  
tempered safety glass

- > **Maximum Door Capacities  
for Two Hinges:**

**Maximum Door Weight:**  
100 lbs. (46 kg)

**Maximum Door Width:**  
31" (787mm)

## Edge Mount Alternate Method 1/8" (3mm) to 3/16" (5mm) Clearance

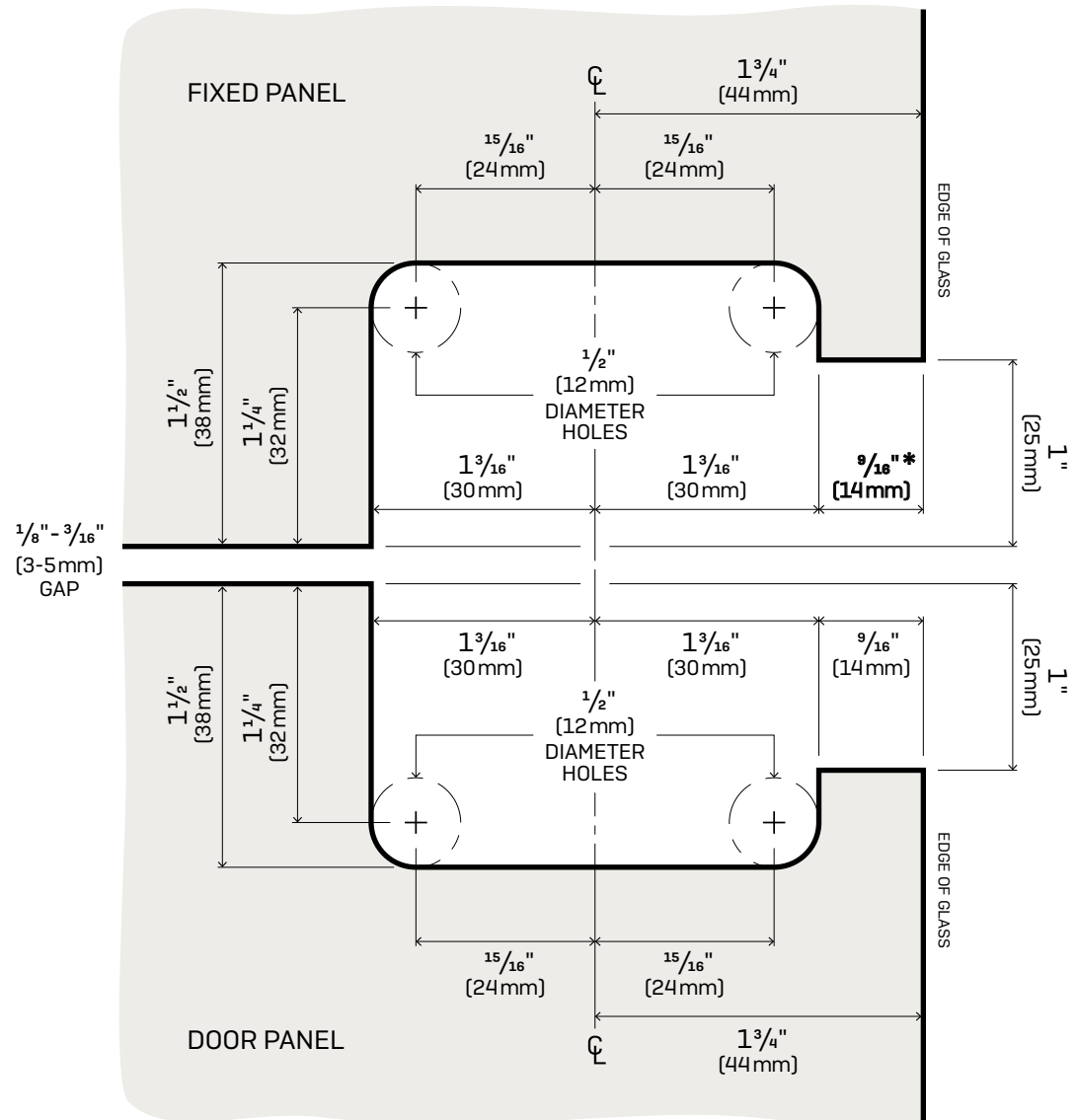
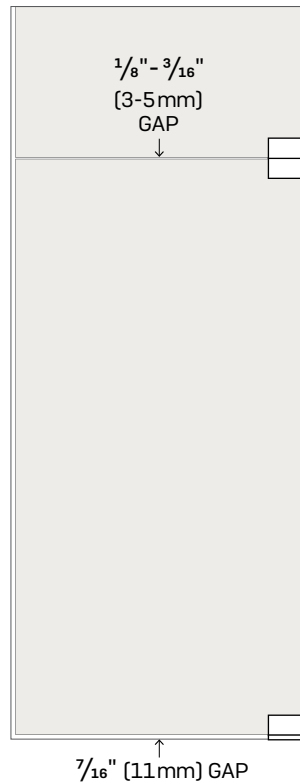

\* The 9/16" (14mm) measurement on the fixed panel outer edge is dependent on the horizontal alignment of the fixed panel being inline with the door panel outer edge. If the fixed panel location is not inline with the door panel, revise this measurement and adjust accordingly.

# Helix

HEL-SPH180

180 Degree  
Glass-to-Glass  
Pivot Hinge

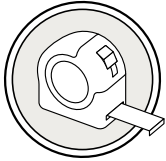

Do not measure images.  
Use specified dimensions.

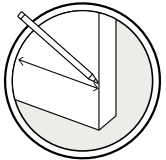

Measure from finished  
edge of glass.

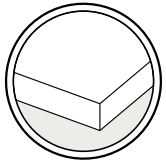

Use monolithic glass.

> **Glass Sizes:**  
5/16" (8mm) to 3/8" (10mm) thick  
tempered safety glass

> **Maximum Door Capacities  
for Two Hinges:**

**Maximum Door Weight:**  
100 lbs. (46 kg)

**Maximum Door Width:**  
31" (787mm)

## Variable Inset Mount Method 1/8" (3mm) to 3/16" (5mm) Clearance



1/8" - 3/16"  
(3-5mm)  
GAP

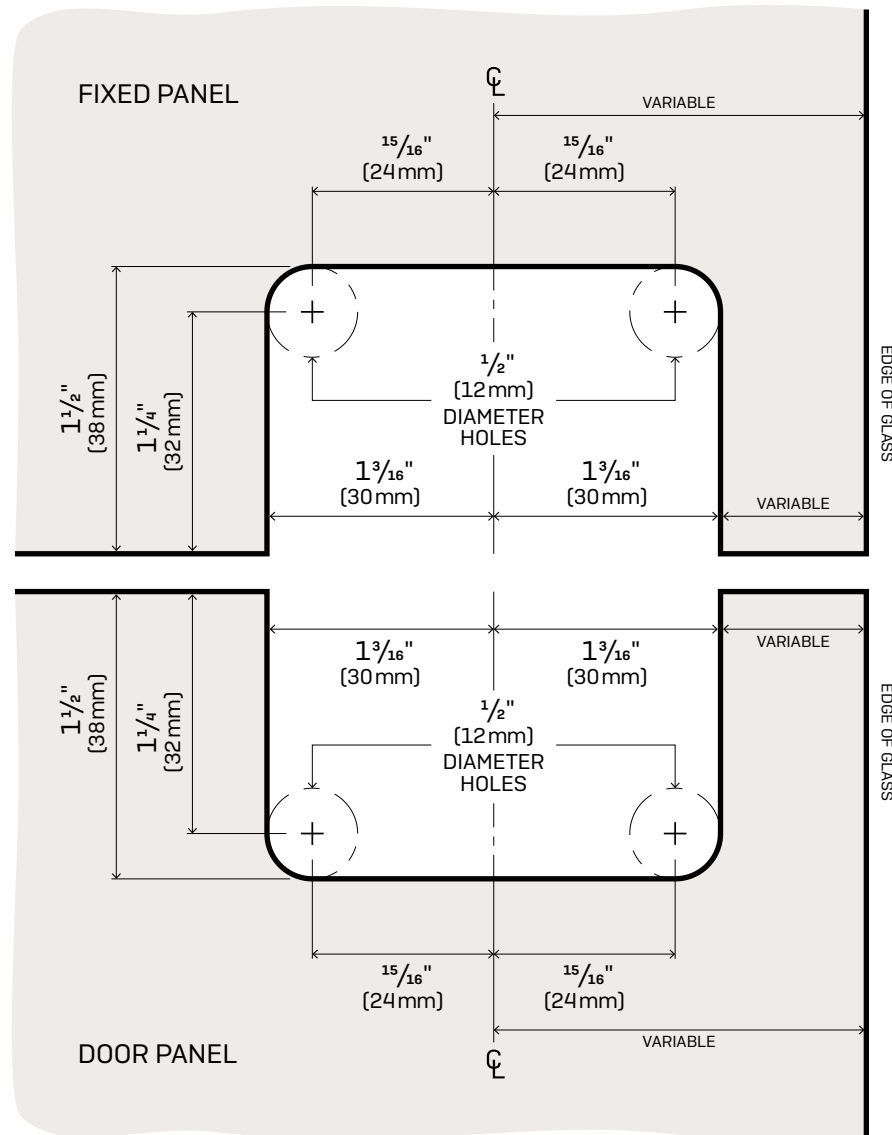

# Helix

HEL-SPH180

180 Degree  
Glass-to-Glass  
Pivot Hinge

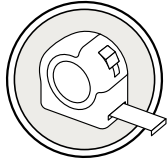

Do not measure images.  
Use specified dimensions.

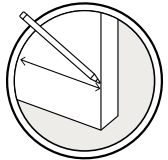

Measure from finished  
edge of glass.

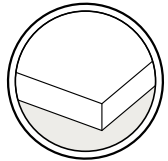

Use monolithic glass.

> **Glass Sizes:**

$\frac{5}{16}$ " (8mm) to  $\frac{3}{8}$ " (10mm) thick  
tempered safety glass

> **Maximum Door Capacities  
for Two Hinges:**

**Maximum Door Weight:**  
100 lbs. (46 kg)

**Maximum Door Width:**  
31" (787mm)

## Transom Mount Method $\frac{1}{8}$ " (3mm) to $\frac{3}{16}$ " (5mm) Clearance

$\frac{1}{8}$ " -  $\frac{3}{16}$ "  
(3-5mm)  
GAP

