

evenflo®

SafeMax™ 3-in-1/ Evolve™ / Transitions™ Child Restraint System Owner's Manual

Keep for future use.

Child Requirements

5-point Harness*

10 to 29.4 kg
(22 to 65 lbs)

71 to 127 cm
(28 to 50 in)

At least 2 years old

Booster With Backrest*

18 to 54.4 kg
(40 to 120 lbs)

112 to 145 cm
(44 to 57 in)

At least 4 years old

Booster Without Backrest*

18 to 54.4 kg
(40 to 120 lbs)

112 to 145 cm
(44 to 57 in)

At least 4 years old

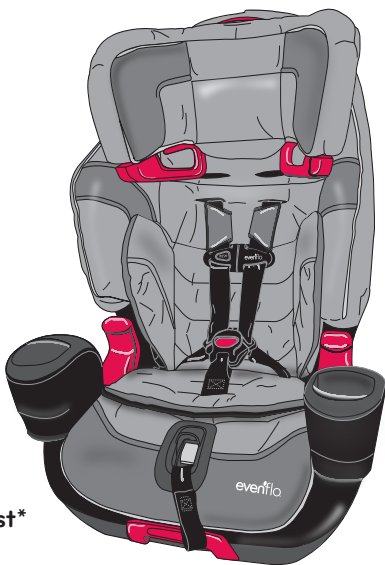

* See inside cover for complete requirements.

Para instrucciones en Español, llamar al: 1-800-233-5921.

⚠️ WARNING:

To reduce the risk of serious injury or death, read this owner's manual prior to installing and using this child restraint.

More children are killed every year as passengers in car crashes than by any other type of injury.

To reduce the risk of **SERIOUS INJURY** or **DEATH**, read this owner's manual and your vehicle owner's manual before installing and using this child restraint. Using a child restraint makes a big difference. By properly using this child restraint and following these instructions (and the instructions that accompany your vehicle), you will greatly reduce the risk of serious injury or death to the child from a crash. Do not be misled by the commonly used term "safety seat"; no restraint system can prevent all injuries in all crashes. Many properly restrained adults and children are injured in motor vehicle crashes, including relatively minor crashes. A properly used child restraint is the best way to minimize injuries to the child and to increase the chances for the child's survival in most crashes.

U.S. REGULATORY NOTICE

This child restraint meets all applicable requirements of Federal Motor Vehicle Safety Standard 213.

CANADIAN REGULATORY NOTICE (Model numbers ending in "C")

This child restraint meets all applicable requirements of Canadian Motor Vehicle Safety Standards CMVSS 213 and 213.2.

Symbol Legend



Airbag Symbol – Alerts you to important information about airbag safety.



LATCH Symbol – Alerts you to important information about LATCH safety.



Tether Anchor Symbol – Alerts you to important information about tether anchor safety.



Aircraft Symbol – Alerts you to important information about aircraft safety.

Table of Contents

Important Information

Child Requirements	2
Warnings	3
LATCH Warnings	6
Safe Practices	8
Recall Information for U.S. Customers	8
Public Notice for Canadian Customers	8
Motor Vehicle / Aircraft Usage	9
Storing Your Instructions	9
Visual Glossary	10
Child Restraint Features	12

5-point Harness

Installation Checklist	15
Installing the Child Restraint with Lower Anchors ...	16
Which Type of Lower Anchor is on Your Child Restraint?	17
Installation with Lower Anchor Hooks.....	17
Installation with Quick Connectors	20
Installation with Vehicle Seat Belt	23
Securing the Child	26
Removing the Child	28
Removing the Tether Strap	29
Removing the Lower Anchors	30
Positioning the Harness Straps	32
Positioning the Crotch Strap	33

Using a Booster Seat

When to Put Your Child in a Booster Seat	34
--	----

Belt Positioning Booster With Backrest

Booster Installation Checklist	37
Converting into a Booster Seat	38

Belt Positioning Booster Without Backrest

Booster Installation Checklist	43
Removing the Backrest	44
Using the Shoulder Belt Clip	45
Attach No-Back Booster Insert (Canada ONLY).....	45

General Information

Reattaching the Backrest	47
Adjusting the Headrest	52
Adjusting the Recline Position	52
Buckle Tongue Storage	53
Removing the Seat Pad	53
Installing the Accessories.....	54
Care and Cleaning	55
Securing Your Child Restraint in Aircraft	56
Installing Child Restraint in Aircraft	57
Replacement Parts	59
Limited Warranty	60

Child Requirements

Warning: Failure to follow these Child Requirements could result in serious injury or death.

This child restraint is designed for use by children in **forward-facing** orientation only. To use this child restraint properly, children **MUST** meet the size and age requirements below. In addition, Evenflo recommends consulting with your child's physician before allowing your child to transition from a **rear-facing** to **forward-facing** child restraint.

The American Academy of Pediatrics (AAP) recommends keeping children **rear-facing** until 2 years old or until they reach the maximum height or weight for their child restraint in **rear-facing** orientation. Additionally, some states' laws require children to be **rear-facing** until age 2. Accordingly, you will see this guidance reflected in the Child Requirements below. Please review any applicable local, state or provincial laws related to child passenger safety before installing and using this child restraint.

5-point Harness

- 10 to 29.4 kg (22 to 65 lbs)
- 71 to 127 cm (28 to 50 in.) and tops of the child's ears are at or below the top of the child restraint headrest
- At least 2 years old

IMPORTANT: Once your child **exceeds** any of the size requirements for **forward-facing** use above, you **MUST** discontinue use of this child restraint with its internal harness and begin using it as a belt-positioning booster seat, if possible. If your child **exceeds** any of the size requirements for **forward-facing** use above **and** is less than 4 years old, however, you **MUST** discontinue use of this child restraint.

Belt-Positioning Booster With Backrest

- 18 to 54.4 kg (40 to 120 lbs)
- 112 to 145 cm (44 to 57 in.) and tops of the child's ears are at or below the top of the child restraint headrest
- At least 4 years old

Belt-Positioning Booster Without Backrest

- 18 to 54.4 kg (40 to 120 lbs)
- 112 to 145 cm (44 to 57 in.) and tops of the child's ears are at or below the top of the vehicle seat headrest
- At least 4 years old

IMPORTANT: Once your child **exceeds** any of the size requirements above for **belt-positioning** use, you **MUST** discontinue use of this seat. Your child may be ready for use of the vehicle belt system only at this time.

WARNING

Air Bag Warnings

- **DO NOT** use this restraint in the front seat of a vehicle equipped with an air bag. Air bags may cause serious injury or death to children 12 years of age and under. If your vehicle has an air bag, refer to your vehicle owner's manual for child restraint installation.
- If the rear seat of your vehicle is equipped with side air bags, refer to the following information for proper usage.
Vehicles built prior to the 2002 model year:
DO NOT use this restraint in a vehicle seating position equipped with a side air bag unless authorized by the vehicle manufacturer.
Model year 2002 and newer vehicles:
Refer to your vehicle owner's manual before placing this restraint in a seating position equipped with a side air bag.
- **DO NOT** place any objects between the restraint and the side air bag, as an expanding air bag may cause the items to strike the child.

The forward-facing rear seat is the safest place for children 12 and under.

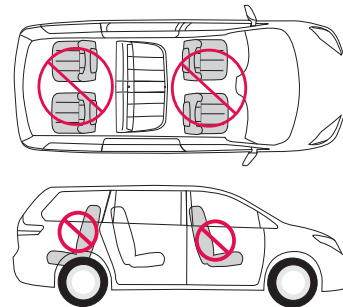

General Warnings

- Failure to follow the Child Requirements for **forward-facing** and **belt-positioning** use of this child restraint could result in serious injury or death. (See page 2 for Child Requirements).
- Failure to follow installation instructions can result in the child striking the vehicle's interior during a sudden stop or crash. Serious injury or death may result. These instructions and the instructions in your vehicle owner's manual must be followed carefully. If there is a conflict between the two, the vehicle owner's manual regarding child restraint installation must be followed.
- **NEVER** leave child unattended.

⚠WARNING

General Warnings - continued

- **DO NOT** use child restraint if it is damaged, broken, or missing parts.
- **DO NOT** use this restraint if it has been involved in a crash. It must be replaced.
- **NEVER** use this child restraint rear-facing.

Location Warnings

- According to statistics, children are safer when properly restrained in a rear seating position than in the front seating position. Generally, the center rear position is safest and should be used if available.
- Some child restraints do not fit all vehicles or all seating locations. There are thousands of combinations of vehicle makes, models, child restraint configurations, seat belt designs, and seat cushion shapes.
- The easiest way to determine whether the child restraint is suitable for a particular seating position is to check for a tight installation. If the child restraint can not be properly installed, **DO NOT** use the child restraint. Consult vehicle owner's manual, try a different seating location or call Evenflo at 1-800-233-5921.
- **ONLY** use this child restraint on **forward-facing vehicle rear seats**. **DO NOT** use this restraint with vehicle seats that face the rear or side.

The forward-facing rear seat is the safest place for children 12 and under.

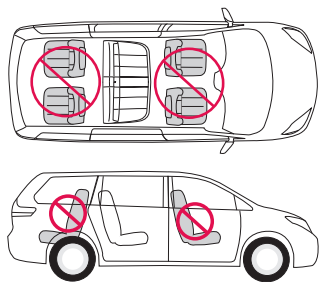

- **ONLY** use this child restraint on vehicle seats with backs that lock into place.
- Adjust or remove the **vehicle** headrest in the seat where the child restraint is to be fastened, so that the back of the child restraint rests against the vehicle seat back.
- The headrest on the vehicle seat in front of the child should be put in its lowest position. The vehicle seat back that the child faces must be fully padded and free of any hard objects.

⚠WARNING

Seat Belt Warnings

If the vehicle seat belts are not routed and fastened correctly, the child restraint may not protect the child in a crash.

For 5-point Harness Use Only

- If the child weighs more than 29.4 kg (65 lbs) or their shoulders are above the highest harness level, you **MUST** use this child restraint as a booster (p. 34).
- **DO NOT** use this child restraint if it moves more than 25 mm (1 in.) side to side or front to back at the vehicle belt path. Serious injury or death may result from poor installation. If you can not tightly secure the child restraint, try again or move it to another location.

For Both 5-point Harness and Booster Use

- **DO NOT** use this child restraint in a vehicle with door-mounted seat belts.
- **DO NOT** use this child restraint in a vehicle with seat belts that automatically move along the vehicle frame when the door is opened. These seat belts will not hold a child restraint properly.
- **DO NOT** allow the seat belt release button to touch the child restraint. Accidental contact may cause the seat belt to release. If necessary, turn the seat belt release button away from the child restraint or move the child restraint to a different location.
- Failure to adjust the harness or vehicle seat belts snugly around the child may result in the child striking the vehicle's interior during a sudden stop or crash. Serious injury or death may occur.
- Remove locking clip from vehicle seat belt when not used with a child restraint, or the vehicle seat belt will not properly restrain an adult or child. Serious injury or death may occur.

For Booster Use Only

- Warning! Use only the vehicle's lap and shoulder belt system when restraining the child in this booster seat.
- The shoulder belt **MUST** be threaded through the shoulder belt guide (p. 36).
- **DO NOT** use this booster seat if the child's ears are above the back of the booster seat headrest.
- The shoulder belt **MUST NOT** cross the child's neck **or** fall off the child's shoulder. If you can not adjust the shoulder belt to **properly lay midway between the child's shoulder and neck AND at or above the shoulder**, try another seating location or do not use the booster seat.

⚠WARNING

LATCH Warnings

For 5-point Harness Use Only

- **DO NOT** use the Lower Anchors of the child restraint anchorage system (LATCH system) to attach this child restraint when restraining a child weighing more than 20.4 kg (45 lbs) with the internal harnesses of the child restraint.
- The LATCH system is intended to be used **ONLY** as described in these instructions. Serious injury or death may result from misuse. “**LATCH**” (Lower Anchors and Tethers for **CH**ildren) is a system for attaching the child restraint to your vehicle seat. It can be used in place of the seat belts in vehicles. Refer to your vehicle owner’s manual for the locations of LATCH anchors. **Note:** Your vehicle owner’s manual may refer to this system as “ISOFIX” or “Universal Anchorage System (UAS).”
- In addition to these instructions, read and follow your vehicle owner’s manual regarding installation of the child restraint and LATCH. If there is a discrepancy, follow your vehicle owner’s manual.
- **ONLY** use for securing child restraint to Vehicle Lower Anchor Bars.
- **NEVER** attach two Lower Anchor Hooks to one Vehicle Lower Anchor Bar.
- **NEVER** use the vehicle seat belts when using the Lower Anchors. Using both together can cause slack in a sudden stop or crash.
- When not in use, the Lower Anchors should be securely stored on child restraint. Keep out of reach of children.
- **ALWAYS** be sure that the Lower Anchor Hooks are fully engaged onto the vehicle lower anchor bars by pulling hard on the Lower Anchor Strap. If they are not totally engaged, the Lower Anchors will not secure the child restraint. Serious injury or death may result.
- **DO NOT** use this child restraint if it moves more than 25 mm (1 in.) side to side or front to back at the vehicle belt path on the child restraint. Serious injury or death may result from poor installation. If you can not tightly secure the child restraint, try again or move it to another location.

⚠WARNING

Tether Strap Warnings

- To avoid a strangulation hazard, you **MUST** tightly roll or fold excess or unused Tether Strap and secure with a rubber band. Attach the Tether Hook to the storage clip when not in use (p. 12). This will keep an unused Tether from hitting someone during a crash.

Additional Warnings

- In hot or sunny weather, **ALWAYS** check the areas of the child restraint that may contact your child (e.g., buckle, buckle tongues, etc.) for hot areas before placing him/her into the child restraint. The child could be burned. Cover the child restraint with a light colored blanket when you leave the vehicle.
- This child restraint must be securely fastened to the vehicle, even when unoccupied, using the vehicle seat belts or lower anchor connectors. An unsecured child restraint may injure someone if a crash occurs.
- **DO NOT** use the cup holders to store cans or hard cups. Only for use with soft cups (such as styrofoam or paper).
- **DO NOT** place any cups that contain hot liquids in the cup holders.
- **DO NOT** attach additional padding, toys, or other devices not made by Evenflo or described in these instructions for the child restraint. These items could cause injury in a crash. Additional pads or pillows may interfere with the function of the harness system, or cause breathing problems if the child’s head falls forward, increasing the risk of serious injury or death.
- In cold weather, **DO NOT** dress the child in bulky clothing if the child is riding in a child restraint. Bulky coats/snowsuits make it difficult to tighten the harness to the child, which may allow the child to be ejected from the restraint during a crash. If necessary, place a blanket over the harnessed child without interfering with the child restraint harness system.

⚠WARNING

Safe Practices

- **Everyone rides buckled up or the vehicle does not go.** Make no exceptions for adults or children. If someone unbuckles, stop the vehicle. Being firm and consistent from the start will mean fewer discipline problems as children get older. An unrestrained person can be thrown into and injure other passengers.
- **NEVER** try to tend to a crying baby's needs while driving.
- **NEVER** take a baby out of a child restraint for comforting while the vehicle is moving.
- **DO NOT** allow a child in a vehicle to have objects such as lollipops or ice cream on a stick. The object can injure the child in a crash or if the vehicle swerves or hits a bump.
- **DO NOT** feed an infant who is riding in a child restraint.
- Put sharp or heavy items in the trunk. Anything loose can cause injury in a crash.

Recall Information for U.S. Customers

- Child restraints could be recalled for safety reasons. You must register this restraint to be reached in a recall. Send your name, address, e-mail address if available, and the restraint's model number and manufacturing date to:

Evenflo Company, Inc.,
1801 Commerce Dr.,
Piqua, OH 45356
or call 1-800-233-5921.

or register on-line at:

www.evenflo.com/registercarseat

- For recall information, call the U.S. Government's Vehicle Safety Hotline at 1-888-327-4236 (TTY:1-800-424-9153), or go to: **<http://www.NHTSA.gov>**

Public Notice for Canadian Customers

- To register your child restraint, return your registration card, call 1-937-773-3971, or register on-line at:

www.evenflo.com/registercarseatcanada

- For recall information, call Transport Canada at 1-800-333-0510 (1-613-993-9851 in Ottawa region) or Evenflo at 1-937-773-3971.

Motor Vehicle/Aircraft Usage

When used with the 5-point harness system and properly installed pursuant to these instructions, this restraint is certified for use only in passenger and multi-purpose passenger motor vehicles, buses, and trucks equipped with either lap belts only or lap/shoulder belt systems and in aircraft.



Refer to pages 56 -58 for instructions on installing your child restraint in aircraft.

When used without the 5-point harness system (in booster mode) and properly installed pursuant to these instructions, this restraint is certified for use only in passenger and multi-purpose passenger motor vehicles, buses, and trucks equipped with Type II seat belts. In booster mode, this restraint is **NOT** certified for aircraft use. A belt-positioning booster requires the use of a lap/shoulder belt system, which is not available on aircraft.

Storing Your Instructions

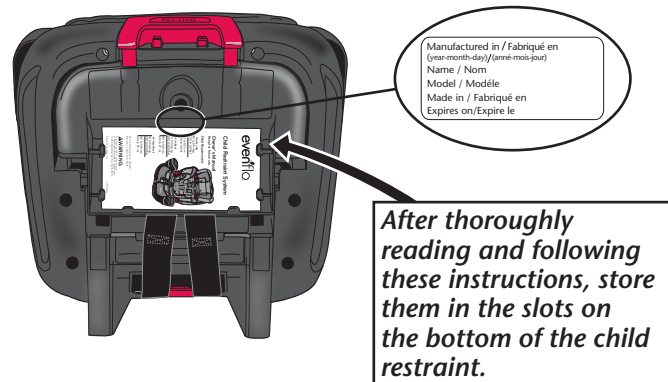

To prevent injury due to hidden damage, lost instructions, outdated technology, etc., discontinue use of this restraint after the expiration date on the label or if it has been involved in a crash.

For future reference, record the **model number** of your child restraint **AND** the **date of manufacture** below.

Model Number: _____

Date of Manufacture: _____

Visual Glossary

Your vehicle components may be different than those pictured. Consult your owner's manual to help you identify your vehicle components.

Back Seat

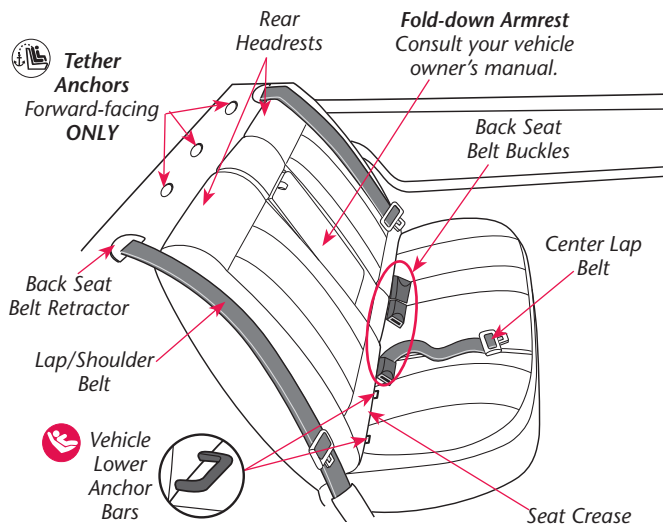

IMPORTANT: If your vehicle has **side air bags**, please refer to the warnings on page 3.

Visual Glossary

Front Seat

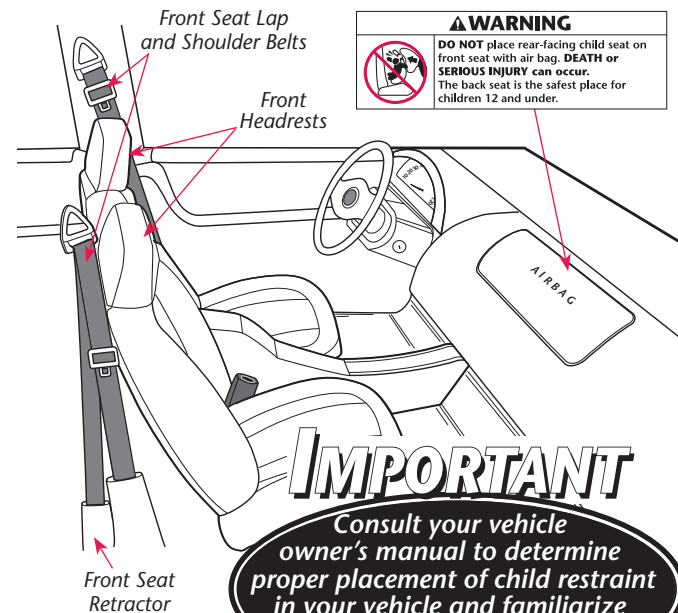

Important

Child Restraint Features

Front

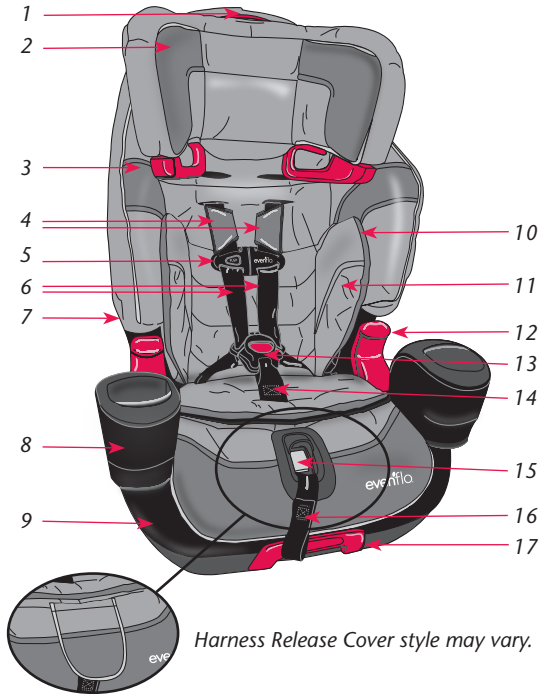

Back

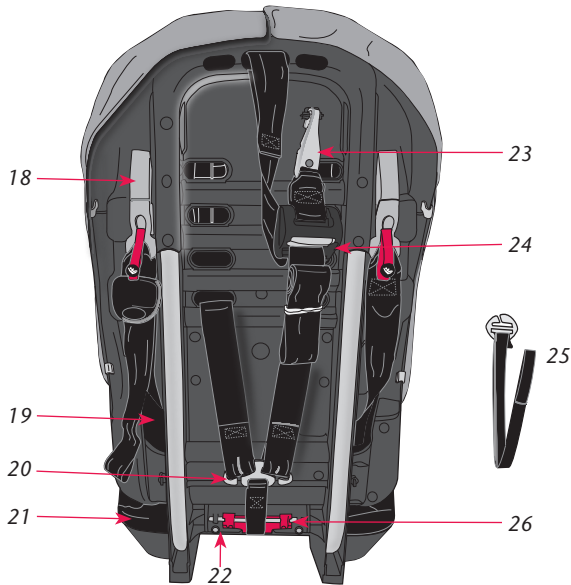

Child Seat Features

Description

1. Headrest Lock Release Button
2. Headrest
3. Shoulder Belt Guide
4. Harness Covers
5. Chest Clip
6. Harness Straps
7. Seat Pad
8. Cup Holder*
9. Base
10. Buckle tongue storage* (behind body pillow)
11. Body Pillow*
12. Lower Belt Guide
13. Crotch Buckle
14. Crotch Strap
15. Harness Release Button
16. Harness Adjuster Strap
17. Recline Lever
18. Quick Connector* Lower Anchor
19. Upper Belt Path
20. Splitter Plate
21. Base
22. Instructions (under seat)
23. Tether Strap and Hook (shown fastened to storage clip)
24. Tether Strap Adjuster (Push Button Release)
25. Shoulder Belt Clip
26. Base Release Lever

* Not all features are available on all models. Styles may vary.

Using the Internal 5-pt Harness

Child Requirements

- **Weight:** 10 – 29.4 kg (22 – 65 lbs)
- **Height:** 71 – 127 cm (28 – 50 in.) and tops of the child's ears are at or below the top of child restraint headrest
- **Age:** At least 2 years old

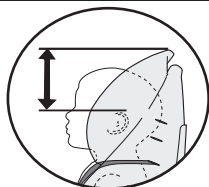

IMPORTANT

When installing this child restraint with **LATCH** or the vehicle seat belt, always use the top anchorage (tether) strap, if a tether anchor is available.

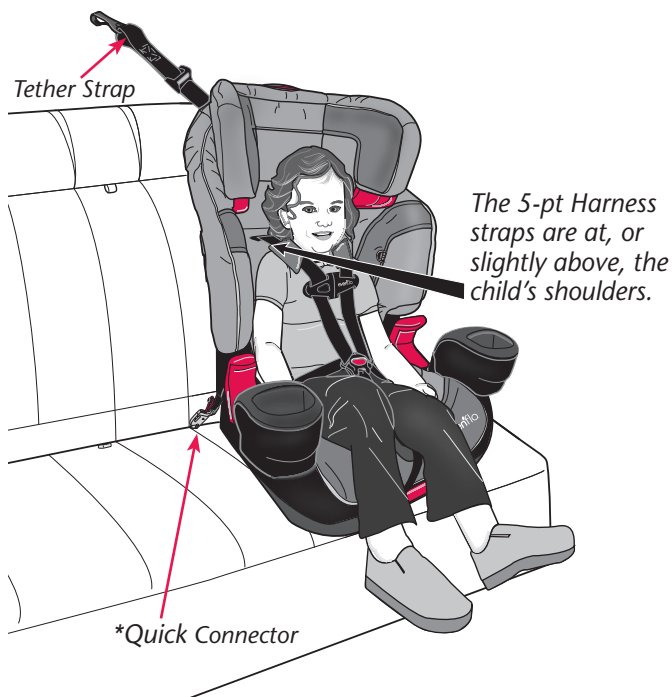

IMPORTANT: Once your child **exceeds** any of the size requirements for **forward-facing** use above, you **MUST** discontinue use of this child restraint with its internal harness and begin using it as a belt-positioning booster seat, if possible. If your child **exceeds** any of the size requirements for **forward-facing** use above **and** is less than 4 years old, however, you **MUST** discontinue use of this child restraint.

Installation Checklist

1. Secure child restraint to the vehicle seat.

- ✓ The recline stand **MUST** be used for children weighing less than 18 kg (40 lbs) (p. 52).
- ✓ Child restraint base sits flat on vehicle seat.
- ✓ Locking clip is installed, if necessary (p. 24).
- ✓ **If the child weighs 20.4 kg (45 lbs) or LESS**, the child restraint is securely installed with one of the following methods through the **upper belt path**:
 - Lower Anchor Hooks* (p. 17)
 - Quick Connectors* (shown at left) (p. 20)
 - Vehicle Seat Belt (p. 23)
- ✓ **If the child weighs MORE than 20.4 kg (45 lbs)**, the child restraint is securely installed with the **VEHICLE SEAT BELT ONLY** (not Lower Anchors) through the **upper belt path** (p. 23).
- ✓ Tether strap is attached and tightened (p. 19, 22, or 25).
- ✓ Harness Covers are installed if the child weighs 18 kg (40 lbs) or less (p. 54).

2. Place the child in the child restraint.

- ✓ The child's back and bottom are flat against the back and bottom surfaces of the child restraint.
- ✓ Tops of the child's ears are at or below the top of the child restraint headrest.

3. Make necessary adjustments.

- ✓ Crotch strap is properly positioned (p. 33).
- ✓ Headrest is adjusted so its bottom is above the harness. (p. 52).

4. Fasten both buckle tongues. Refer to page 26.

5. Tighten Harness - Position and connect chest clip.

- ✓ Harness covers are installed if the child weighs 18 kg (40 lbs) or less (p. 54).
- ✓ Harness straps are snug against the child's shoulders, with no slack (p. 27).
- ✓ Chest clip **MUST** be at armpit level (p. 27).

6. Check your work.

- ✓ To properly protect the child, the child restraint **MUST NOT** move more than 25 mm (1 in.) from **side to side** or from **front to back** at the upper belt path.

* To determine which Lower Anchors are on your child restraint, go to page 17.

Installing the Child Restraint with Lower Anchors

LATCH is a system for attaching the child restraint to your vehicle seat. It is to be used in place of your vehicle's seat belts and can be used in vehicles with LATCH anchors. **Your vehicle owner's manual may refer to this system as ISOFIX, Universal Anchorage System (UAS), or Lower Universal Anchorage System.**

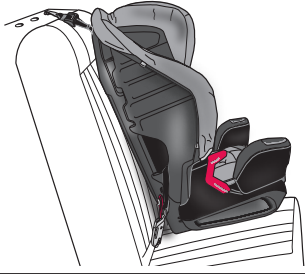

DO NOT install by this method for a child weighing more than 20.4 kg (45 lbs).

WARNING

- **ONLY** use for securing child restraint to Lower Anchor Bars.
- **ALWAYS** read and follow exactly the instructions which accompany your vehicle and child restraint.
- **NEVER** attach two Lower Anchor Hooks to one Vehicle Lower Anchor Bar.
- **DO NOT** use the vehicle seat belts to install a child restraint when using the Lower Anchors.
- The Lower Anchors are intended to be used **ONLY** as described in these instructions. Serious injury or death may result from misuse.
- **ALWAYS** be sure that the Lower Anchor Hooks are fully engaged onto the Vehicle Lower Anchor Bar by pulling hard on the Lower Anchor Strap. If it is not totally engaged, the Lower Anchors will not secure your child restraint. Serious injury or death may result.
- To avoid a strangulation hazard, you **MUST** store the unused Lower Anchors, with all slack removed, in storage area on the back of the seat (p. 31). Roll or fold excess Lower Anchor Strap and secure with a rubber band to prevent serious injury to vehicle occupants.
- In addition to these instructions, read and follow your vehicle owner's manual regarding installation of child restraints and LATCH. If there is a discrepancy, follow your vehicle owner's manual.

Which Type of Lower Anchor is on Your Child Restraint?

In order to properly install your child restraint with the LATCH system, you must first know which type of Lower Anchors are present on your child restraint.

- If your child restraint has **Lower Anchor Hooks**, begin installation by referring to "Installation with Lower Anchor Hooks," below.
- If your child restraint has the **Quick Connectors™**, begin installation by referring to page 20, "Installation with Quick Connectors."

Lower Anchor Hooks



Quick Connector

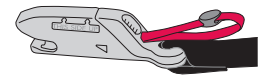

Installation with Lower Anchor Hooks

IMPORTANT:

- Some vehicle manufacturers have lower maximum weight ratings for LATCH anchors. Consult your vehicle owner's manual, or call the vehicle manufacturer, to confirm the limits on your vehicle's LATCH anchors.
- If you are using the vehicle seat belt to secure the child restraint, **DO NOT** use the Lower Anchor Hooks.
- Install this child restraint with the vehicle seat belt (**NOT** Lower Anchor Hooks) if the child weighs more than 20.4 kg (45 lbs).

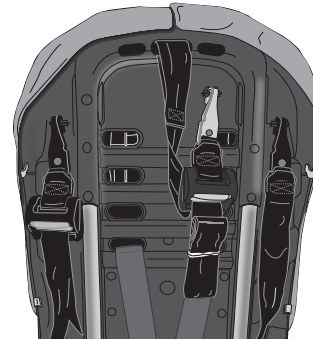

1. Disconnect Tether Hook and Lower Anchor Hooks from the back of the child restraint.

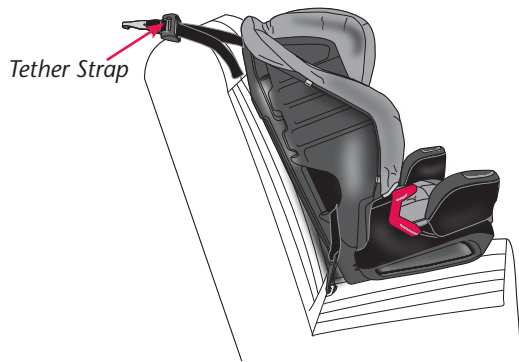

2. Place the child restraint in position.

Set child restraint on vehicle seat in **forward-facing** position. **ALWAYS** make sure bottom of child restraint sits flat on vehicle seat and positioned, as shown. Lay the Tether Strap over the back of the vehicle seat.

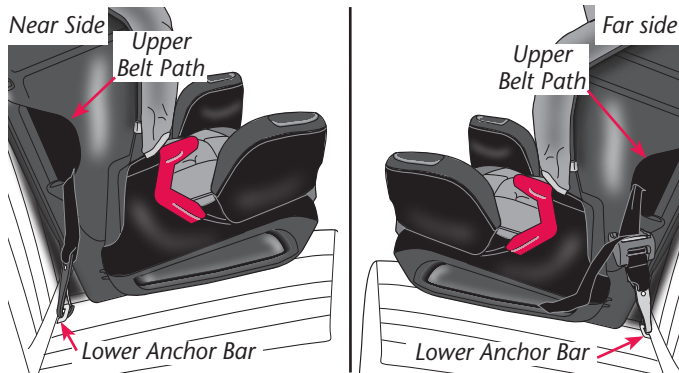

3. Attach Lower Anchor Hooks.

With the Lower Anchor harness through the upper belt path, as shown above, attach a Lower Anchor Hook onto the Vehicle Lower Anchor Bar on each side of the child restraint.

IMPORTANT: Make sure both Lower Anchor Hooks are facing upward, as shown, and the Lower Anchor Straps are not twisted.

Correct

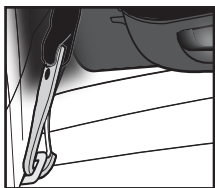

Incorrect

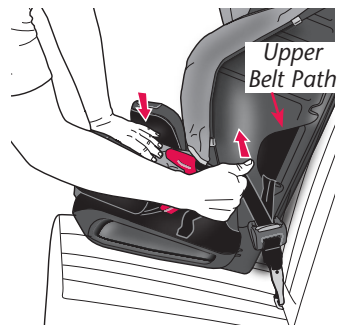

4. Secure the child restraint.

Using your full weight, push the child restraint firmly into the vehicle seat while pulling up on the Lower Anchor Strap to tighten.

IMPORTANT: To properly protect the child, the child restraint **MUST NOT** move more than 25 mm (1 in.) from side to side or from front to back **at the upper belt path**. If you cannot tightly secure the child restraint, try again or move it to another location, or install with the vehicle seat belt.



5. Connect and Tighten Tether Strap.

Connect the Tether Hook to the anchor behind the vehicle seat, as shown. (Please consult your vehicle owner's manual, as Tether Anchor locations may vary.) Pull the strap and tighten the Tether securely.

Note: The installed seat should be positioned as shown above.

IMPORTANT:

- The Tether Strap **MUST** be used when installing this child restraint with the Lower Anchor Hooks.
- If your Tether Strap is too short to reach your vehicle Tether Anchor, you will need a Tether Extender. Please call ParentLink at 1-800-233-5921 (U.S.) or 1-937-773-3971 (Canada), or 01-800-706-12-00 (Mexico).

Installation with Quick Connectors

IMPORTANT:

- Some vehicle manufacturers have lower maximum weight ratings for LATCH anchors. Consult your vehicle owner's manual, or call the vehicle manufacturer, to confirm the limits on your vehicle's LATCH anchors.
- If you are using the vehicle seat belt to secure the child restraint, **DO NOT** use the Quick Connectors.
- Install this child restraint with the vehicle seat belt (**NOT** Quick Connectors) if the child weighs **more** than 20.4 kg (45 lbs).

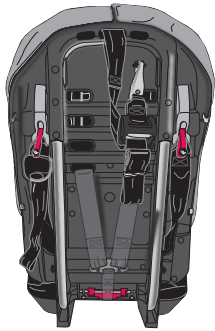

1. Disconnect Tether Hook and Quick Connectors from the back of the child restraint.

2. Place the child restraint in position.

Set child restraint on vehicle seat in forward-facing position. **ALWAYS** make sure bottom of child restraint sits flat on vehicle seat and positioned, as shown. Lay the Tether Strap over the back of the vehicle seat.

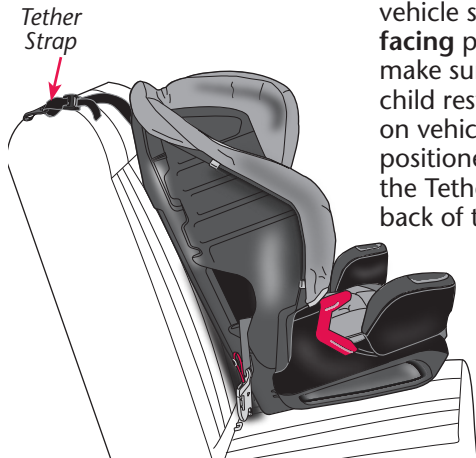

Installation with Quick Connectors

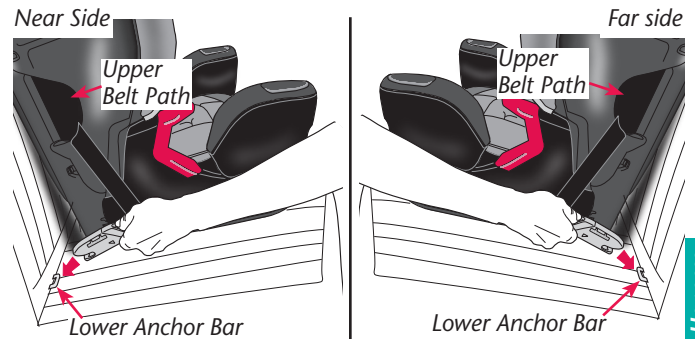

3. Attach Quick Connectors.

With the Quick Connector harness through the upper belt path, as shown above, push a Quick Connector onto the Lower Anchor Bar on each side of the child restraint.

Note: You may need to vary the angle of the Quick Connectors, as shown above, to attach to the anchor.

IMPORTANT: Make sure both Quick Connectors are facing upward, as shown, and the straps are not twisted.

Correct

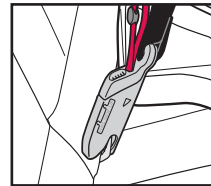

Incorrect

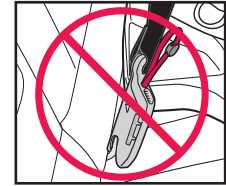

4. Secure the child restraint.

Using your full weight, push the child restraint firmly into the vehicle seat while pulling up on the Quick Connector Strap to tighten.

IMPORTANT: To properly secure this child restraint, it **MUST NOT** move more than 25 mm (1 in.) from side to side or from front to back **at the upper belt path**. If you can not tightly secure the child restraint, try again, move it to another location, or install with vehicle seat belt.

Installation with Quick Connectors



5. Connect and tighten Tether Strap.

Connect the Tether Hook to the Anchor behind the vehicle seat, as shown. (Please consult your vehicle owner's manual, as Tether Anchor locations may vary.) Pull the strap and tighten the Tether securely.

Note: The installed seat should be positioned as shown above.

IMPORTANT:

- The Tether Strap **MUST** be used when installing this child restraint with the Quick Connectors.
- If your Tether Strap is too short to reach your vehicle Tether Anchor, you will need a Tether Extender. Please call ParentLink at 1-800-233-5921 (U.S.) or 1-937-773-3971 (Canada), or 01-800-706-12-00 (Mexico).

Installation with Vehicle Seat Belt

IMPORTANT:

- If the child weighs **more** than 20.4 kg (45 lbs), install this child restraint with the vehicle seat belt (**NOT** Lower Anchors).
- Before installing this child restraint with the vehicle seat belt, you **MUST** make sure the Lower Anchor Hooks or Quick Connectors are attached to the storage hooks on the back of the child restraint.
- Check your vehicle owner's manual to determine how to lock your seat belt for child restraint installation. The seat belt must be locked to properly secure the child restraint.
- When using the vehicle seat belt to secure the child restraint, **DO NOT** use the Lower Anchors. Using both together can cause slack in a sudden stop or crash.

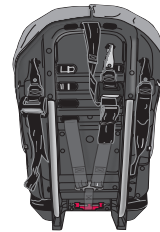

1. Disconnect Tether Hook from the back of the child restraint.



2. Place the child restraint in position.

Set child restraint on vehicle seat in **forward-facing** position. **ALWAYS** make sure bottom of child restraint sits flat on vehicle seat and positioned, as shown. Lay the Tether Strap over the back of the vehicle seat.

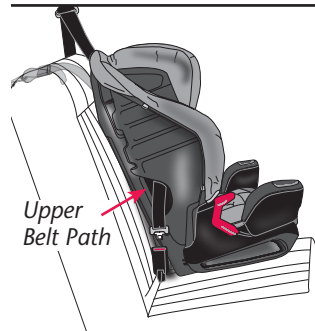

3. Route seat belt through upper belt path.

Route the seat belt buckle tongue through the upper belt path, as shown.

Installation with Vehicle Seat Belt

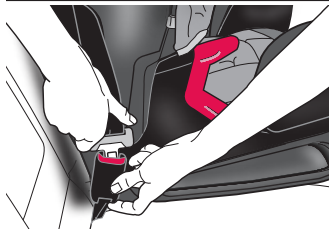

4. Buckle seat belt.



5. Remove all slack from the seat belt.

Using your full weight, push the child restraint firmly into the vehicle seat while tightening the seat belt to remove excess slack.

6. Install Locking Clip (not included), if necessary.

If your vehicle was built **prior to model year 1996**, and has a lap/shoulder belt that is equipped with an emergency locking retractor (ELR) AND sliding latch plate, you **MUST** use a Locking Clip. Check your vehicle owner's manual to identify which vehicle belt system is in your vehicle.

Locking Clip installed properly

13 mm
(0.5 in.)

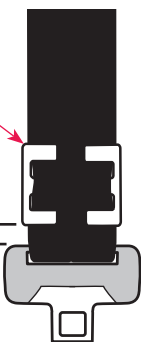

If your vehicle is **model year 1996 or newer**, it likely has a vehicle belt system that can be locked when tightened, and will not require use of a Locking Clip. **Consult your vehicle owner's manual before installing a locking clip.**

If your vehicle requires a Locking Clip, please call ParentLink at 1-800-233-5921 (U.S.) or 1-937-773-3971 (Canada), or 01-800-706-12-00 (Mexico) to obtain a Locking Clip and instructions on how to install and use it.

⚠ WARNING

- Remove Locking Clip from vehicle seat belt when not used with a child restraint, or the vehicle seat belt will not properly restrain an adult or child. Serious injury could occur.
- DO NOT** use a Locking Clip in booster mode.

Installation with Vehicle Seat Belt

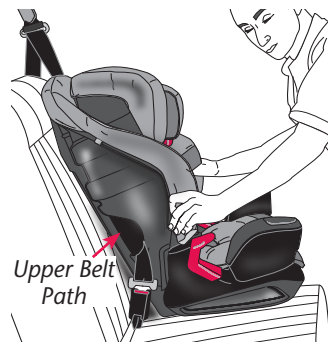

7. Ensure child restraint is secure.

Hold the child restraint near the upper belt path, as shown, and try to move it in all directions.

IMPORTANT: To properly secure this child restraint, it **MUST NOT** move more than 25 mm (1 in.) from side to side or from front to back **at the upper belt path**. If you can not tightly secure the child restraint, try again or move it to another location.



8. Connect and tighten Tether Strap.

Connect the Tether Hook to the Anchor behind the vehicle seat, as shown. (Please consult your vehicle owner's manual, as Tether Anchor locations may vary.) Pull the strap and tighten the Tether securely.

Note: The installed seat should be positioned as shown above.

IMPORTANT:

- The Tether Strap **MUST** be used when installing this child restraint with the vehicle seat belt, if a tether anchor is available.
- If your Tether Strap is too short to reach your vehicle Tether Anchor, you will need a Tether Extender. Please call ParentLink at 1-800-233-5921 (U.S.) or 1-937-773-3971 (Canada), or 01-800-706-12-00 (Mexico).

Securing the Child

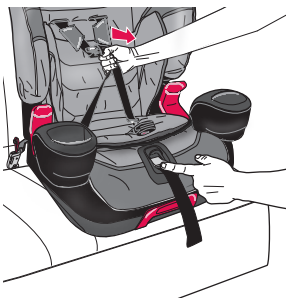

1. Loosen harness straps.

Actuate the harness release lever on the front of the seat while pulling the harness straps.

2. Position harness straps.

Unfasten chest clip and place the child in the child restraint. Bring each harness strap over the child's shoulders.



Note: Straps must be positioned at the child's shoulder level or slightly above. Harness Covers **MUST** be installed when using the 5-point harness for children weighing 18 kg (40 lbs) or less (see page 54).

Headrest is adjusted so its bottom is above the harness (see page 52).

IMPORTANT: The child's back and bottom should be flat against the restraint. If there is a gap, the child will not be comfortable.

3. Buckle the harness.

Insert both buckle tongues into the buckle.

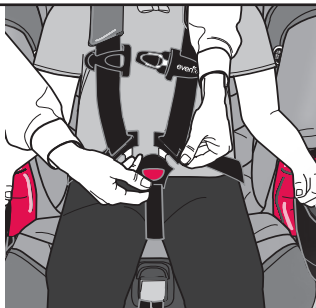

Note: Make sure crotch buckle is positioned properly (p. 33).

IMPORTANT: Pull up on the harness straps to ensure that the buckle tongues are fastened securely.

Securing the Child



4. Fasten and adjust chest clip.

Snap the two halves of the chest clip together, as shown, and slide to armpit level.

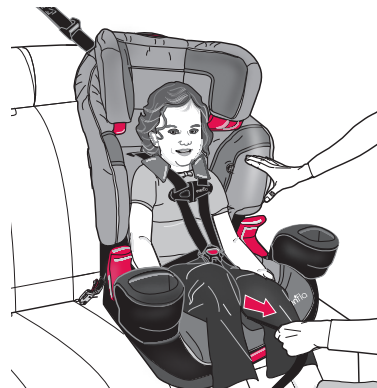

5. Tighten harness.

Pull the harness adjuster strap at the front of the seat to tighten the harness.

Note: Check the harness straps near the shoulders for slack. You should **NOT** be able to pinch the harness (see illustration). Adjust as needed.

IMPORTANT: A snug strap should not allow any slack. It lies in a relatively straight line without sagging. It does not press on the child's flesh or push the child's body into an unnatural position.

Removing the Child



1. Loosen harness straps.

Actuate the harness release lever on the front of the seat while pulling the harness strap outward behind the fastened chest clip.



2. Disconnect chest clip.

Push the release button and pull the chest clip apart.

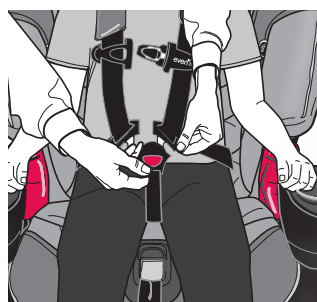

3. Unbuckle harness.

Press the red button on the buckle and release both buckle tongues.

You may now remove the child.

Removing the Tether Strap

1. Loosen adjuster.

The Tether Strap that comes with your child restraint will be one of the two types below (A or B).

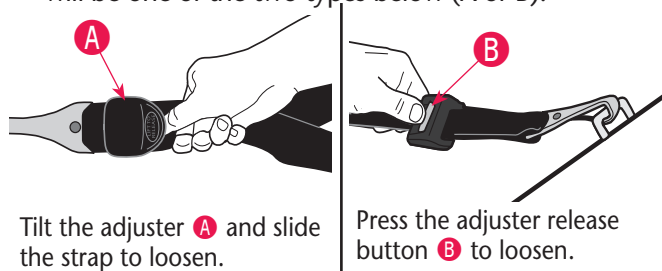

2. Remove Tether Hook from Anchor.

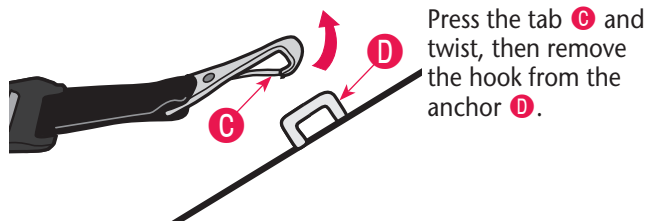

3. Attach Tether Hook to storage clip.

⚠ WARNING

- To avoid a strangulation hazard, you **MUST** tightly roll or fold excess Tether Strap and secure with the strap/rubber band.
- Attach the Tether Hook **E** to the storage clip when not in use. This will keep an unused Tether from hitting someone during a crash.



Removing the Lower Anchors

1. Loosen adjuster.

TIP!

Using your full weight, push the child restraint into the vehicle seat while loosening the adjuster.

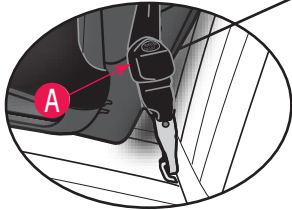

Tilt the adjuster **A** and slide the strap to loosen.

Or

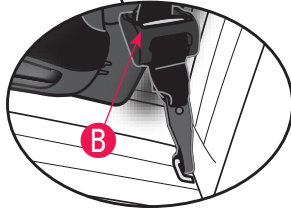

Press the adjuster release button **B** to loosen.

2. Remove Lower Anchor Hooks from Anchor.

The Lower Anchor Hooks that come with your child restraint will be one of the two types below.

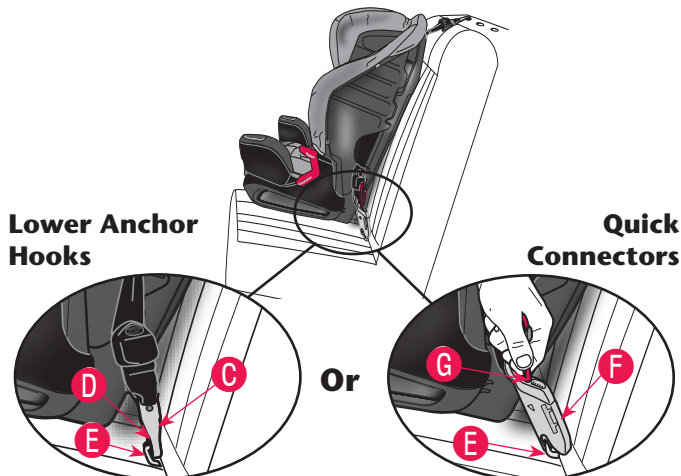

To remove the hook **C**, press the tab **D** and twist, then remove from anchor **E**.

To remove the clip **F**, pull the red release strap **G** and remove clip from anchor **E**.

Removing the Lower Anchors

3. Attach Lower Anchor Hooks to storage clips.

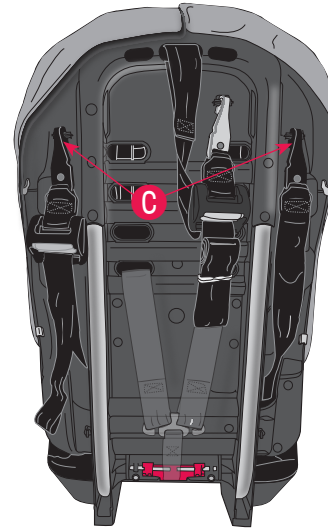

When the Lower Anchors are not in use, you **MUST** attach the hooks **C** to the back of the child restraint. A loose Lower Anchor Strap and Hook may injure your child.

With 5-Point Harness

Positioning the Harness Straps

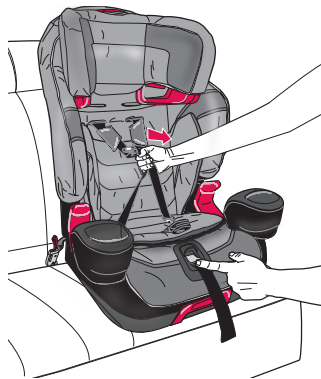

1. Loosen harness straps.

Actuate the harness release lever on the front of the seat while pulling the harness straps.

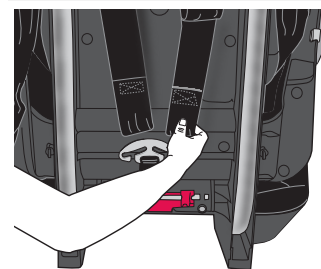

2. Remove both harness straps from the splitter plate on the back of the child restraint.

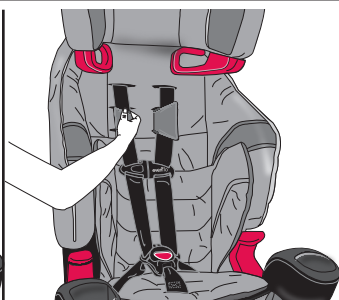
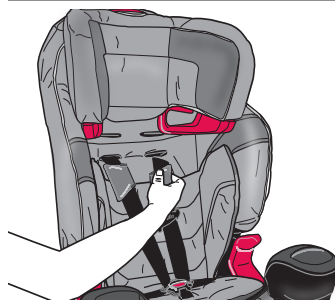

3. Move harness straps.

Remove both harness straps from the slots and feed them into the new slot, as shown.

Pull the harness straps to the back of the child restraint.

Note: Straps must be positioned at the child's shoulder level or slightly above. Harness Covers **MUST** be installed when using the 5-point harness for children weighing 18 kg (40 lbs) or less (see page 54).

IMPORTANT: When inserting harness straps through the slots in the seat pad, make sure you route them correctly through their corresponding slots in the seat shell.

Positioning the Harness Straps

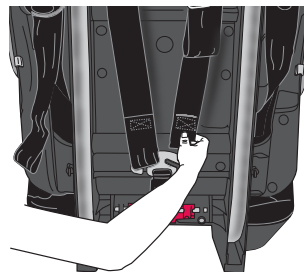

4. Attach harness straps to splitter plate.

Attach the loop at the end of each harness strap onto the splitter plate.



IMPORTANT: Make sure both harness straps are installed **completely** on the splitter plate, as shown.

Positioning the Crotch Strap

To reposition the crotch strap, first turn the child restraint upside down. Turn the crotch strap harness anchor **A** sideways and push it through the slot in the bottom of the seat shell **B**.

Reposition the harness anchor into the other slot. Make certain the harness anchor is properly seated against the seat shell **B**.

Note: The crotch strap should be snug against the child. Choose the slot that is closest to the child **AND** the most comfortable for the child but **NEVER** under the child's bottom.

IMPORTANT: When inserting the crotch strap harness anchor through the slot in the seat pad, make sure you route it correctly through its corresponding slot in the seat shell.

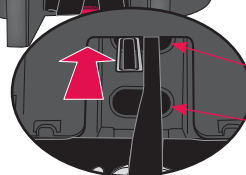
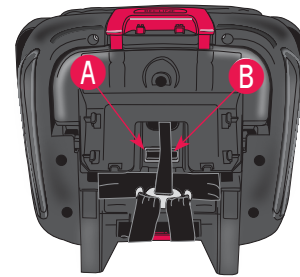
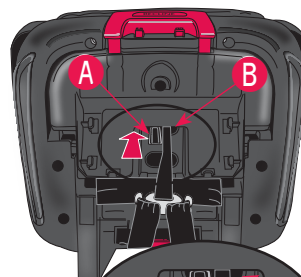

Front slot

Rear slot

When to Put Your Child in a Booster Seat

Booster seats raise the child up and help to position the vehicle lap and shoulder belt correctly. When the child is properly restrained in a booster seat, their risk of injury in all types of crashes is reduced, as the lap and shoulder belt provides excellent restraint of both the upper and lower torso.

It is important for the child to sit properly within the vehicle seat belts. When the vehicle seat belt is buckled, the lap belt should be low on the hips, just touching the thighs, and the shoulder belt should lie across the middle of the shoulder. If the child leans out or moves the belt behind the back or places it under the arm, **it will not provide the intended restraint.**

There are a number of things to consider when deciding whether a child is ready to sit in a booster seat, including: the weight and height ratings on his/her current child seat, the child's own weight and height, his/her maturity, and the seating positions available in your vehicle.

How is a booster seat used?

Using a booster seat is very similar to buckling yourself into the vehicle:

- Read the instruction manuals for both the booster seat and the vehicle before you start.
- Put the booster in the back seat in a location with a lap and shoulder belt. **Never use a booster with only a lap belt**, as this could cause serious injuries.
- After the child is in the booster, pull the lap and shoulder belt across him/her and buckle it.
- Check that the shoulder belt lies across the middle of the shoulder and that the lap belt is low on the hips, just touching the thighs.

How can you tell if your child is ready to transition to a booster seat?

You should consider using a booster seat if the following conditions apply:

- The child is mature enough to sit in the booster seat and not put the belts under his/her arm or behind their back.
- The child is approaching the weight or height limit of the child restraint they are currently using. (Even children who have not outgrown their toddler seat can benefit from the use of a booster seat, if it is used properly.)
- If you have a vehicle that does not have a tether anchorage but has lap/shoulder belts available in the back seat, a booster seat may provide better protection than an internal harness seat without the tether.

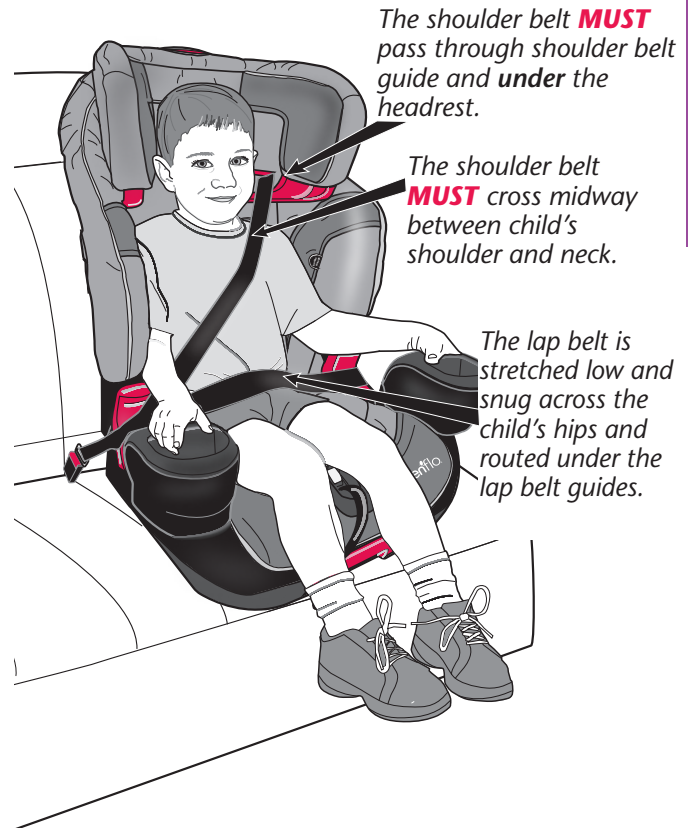

Using Your Booster Seat With the Backrest

Child Requirements

- **Weight:** 18 – 54.4 kg (40 – 120 lbs)
- **Height:** 112 – 145 cm (44 – 57 in.) and tops of the child's ears are at or below the top of child restraint headrest
- **Age:** At least 4 years old

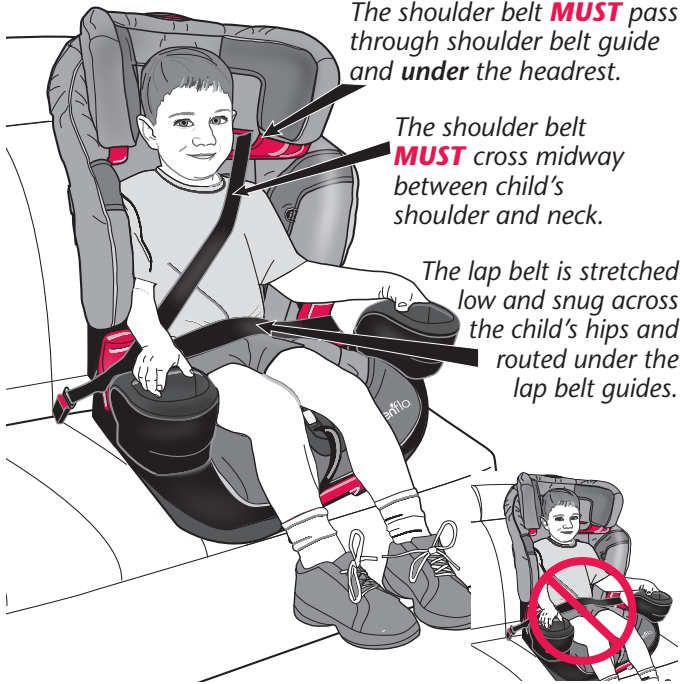
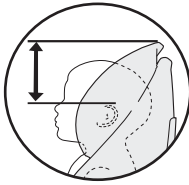

The shoulder belt **MUST** pass through shoulder belt guide and **under** the headrest.

The shoulder belt **MUST** cross midway between child's shoulder and neck.

The lap belt is stretched low and snug across the child's hips and routed under the lap belt guides.

IMPORTANT: Once your child **exceeds** any of the size requirements above for **belt-positioning** use, you **MUST** discontinue use of this seat. Your child may be ready for use of the vehicle belt system only at this time.

IMPORTANT

Always secure the booster seat with the lower anchor connectors or vehicle seat belt when not occupied.

An unsecured booster seat can fly into and injure other occupants in the event of a crash.

Booster Installation Checklist

- 1. Convert child restraint to booster seat.**
See "Converting into a Booster Seat", (p. 38).
- 2. Secure booster seat to the vehicle seat.**
 - ✓ Make sure the booster seat is in the upright position, (p. 52).
 - ✓ Make sure the bottom and back of the booster seat are touching vehicle seat and back.
- 3. Place the child in the booster seat.**
Make sure the child's back and bottom are flat against the back and bottom surfaces of the booster seat.
- 4. Adjust headrest for proper shoulder belt fit.**
The top of the child's ears are at, or below, the top of the child restraint headrest and the shoulder belt **MUST** cross midway between the child's shoulder and neck, as shown at left.
- 5. Secure child and booster seat to vehicle seat.**
Stretch the lap/shoulder belt across the child and fasten the buckle. Make certain the shoulder belt is threaded through the shoulder belt guide on the headrest.
- 6. Check your work.**
Make sure the lap belt is stretched low and snug across the child's hips, within the belt guides, and fastened into the buckle. The shoulder belt must cross the child midway between his/her shoulder and neck.

⚠ WARNING

- The shoulder belt **MUST NOT** cross the child's neck or fall off the child's shoulder. If you can not adjust the shoulder belt to properly lay midway between the child's shoulder and neck **AND** at or above the shoulder, try another seating location, or do not use the booster seat.



Converting into a Booster Seat

1. Loosen harness.

Actuate the harness release lever while pulling outward on the harness straps, as shown.

Note: Disconnect chest clip and unbuckle harness (see page 28).

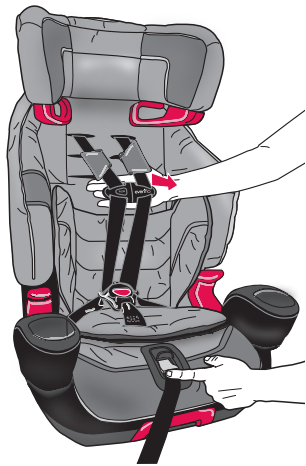

2. Remove both harness straps from the splitter plate and pull them through to the front of the seat.

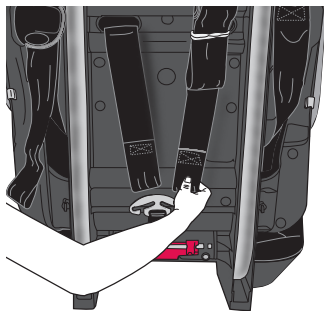

3. Disconnect J-clips and retaining strips, then remove the seat pad (see page 53).

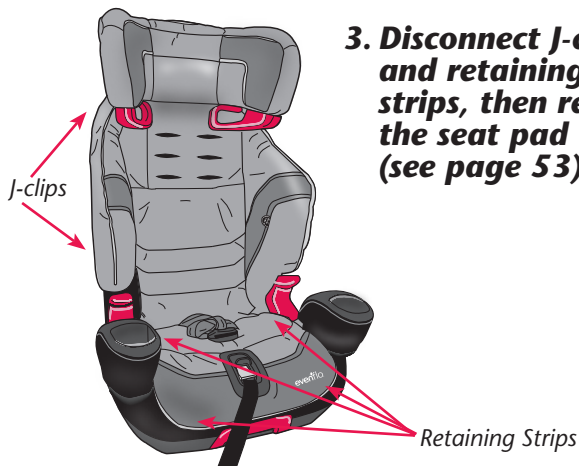

Converting into a Booster Seat

4. Route the harness straps through adjustment slots, then attach to splitter plate on back of child restraint.

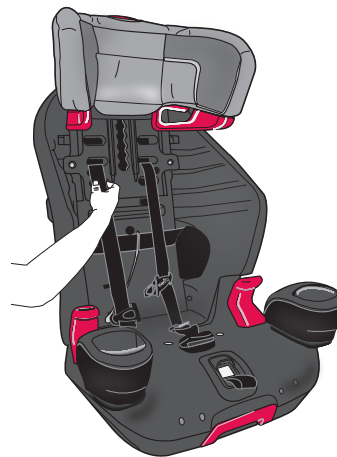

IMPORTANT: Make sure both harness straps are installed **completely** on the splitter plate.

5. Push the chest clip and buckle tongues through the upper belt path to the back of the child restraint.

Buckle the chest clip behind the child restraint, as shown in illustrations,

A, **B** and **C**.

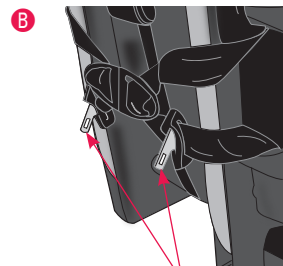
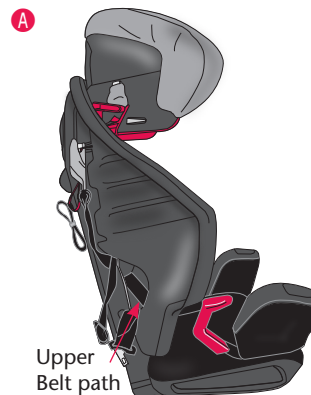

Buckled behind the seat.

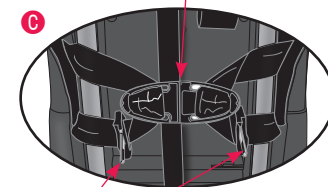

Buckle tongues

Converting into a Booster Seat

6. Remove the crotch strap.

Locate the crotch strap anchor on the bottom. Turn the anchor sideways and push it through the seat shell to remove, as shown.

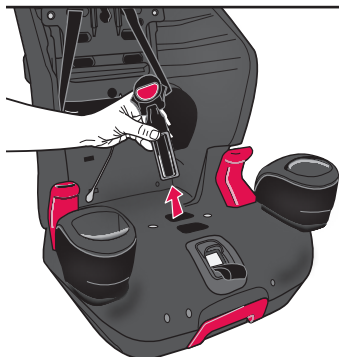
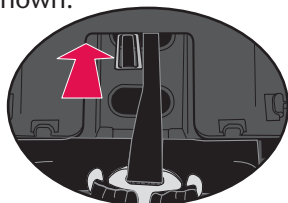

Insert the crotch strap anchor back into the opening from the bottom of the child restraint.

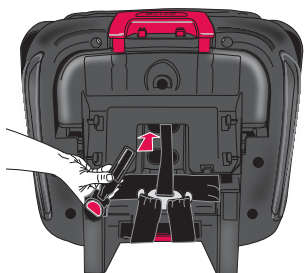

Pull the anchor through the seat and adjust so it lies flat, as shown.

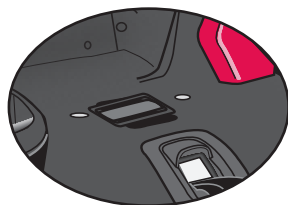
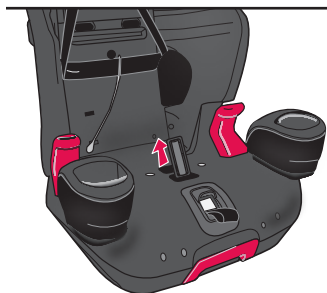

Converting into a Booster Seat



7. Reattach the seat pad.

Your child restraint is now in Booster Mode and ready for a child who meets the following requirements:

- **Weight:** 18 – 54.4 kg (40 – 120 lbs)
- **Height:** 112 – 145 cm (44 – 57 in.) and tops of the child's ears are at or below the top of child restraint headrest
- **Age:** At least 4 years old

Note: To convert the seat back into 5-point harness mode, reverse these steps.

Using Your Booster Seat Without the Backrest

Child Requirements

- **Weight:** 18 to 54.4 kg (40 to 120 lbs)
- **Height:** 112 to 145 cm (44 to 57 inches) and tops of the child's ears are at or below the top of vehicle seat headrest
- **Age:** At least 4 years old

The shoulder belt **MUST** cross midway between child's shoulder and neck. Use shoulder belt clip, if necessary.

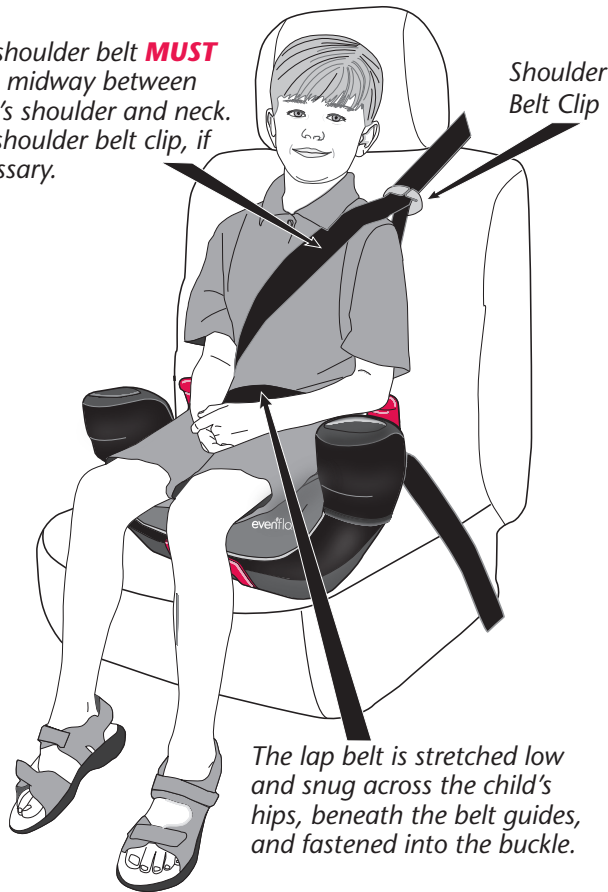

The lap belt is stretched low and snug across the child's hips, beneath the belt guides, and fastened into the buckle.

IMPORTANT: Once your child **exceeds** any of the size requirements above for **belt-positioning** use, you **MUST** discontinue use of this seat. Your child may be ready for use of the vehicle belt system only at this time.

Installation Checklist

1. **Remove the backrest from the booster seat.**
See "Removing the Backrest", (p. 44.)
2. **Place the booster seat on the vehicle seat.**
Make sure the booster seat is in the upright position, (p. 52).
3. **Set the child in the booster seat.**
Make sure the child's back is flat against the vehicle seat and the child's bottom is flat against the booster seat.
4. **Secure the child and booster seat to the vehicle seat.**
Stretch the lap/shoulder belt across the child and fasten the buckle.
5. **Use the shoulder belt clip, if necessary.**
If the shoulder belt does not properly lay midway between the child's shoulder and neck, attach and adjust the belt clip. See "Using the Shoulder Belt Clip", (p. 45).

⚠ WARNING

The shoulder belt **MUST NOT** cross the child's neck **or** fall off the child's shoulder. If you cannot adjust the shoulder belt to properly lay midway between the child's shoulder and neck, try another seating location or do not use the booster seat.



6. **Check your work.**
Make sure the lap belt is stretched low and snug across the child's hips, beneath the belt guides, and fastened into the buckle. The shoulder belt must cross the child midway between his/her shoulder and neck.
Note: If the vehicle's shoulder belt naturally crosses the child's shoulder, you do not need to use the shoulder belt clip.

IMPORTANT

Always secure the booster seat with the vehicle seat belts when not occupied. An unsecured booster seat can fly into and injure other occupants in the event of a crash.

Removing the Backrest

1. Lay the booster seat on its back.

Remove crotch strap to make removing the backrest easier (p. 49).

2. Push release lever to remove backrest.

Use your thumb to push the release lever **A** on the bottom of the base **B**, as shown, then slide the base off of the backrest **C**.

Note: Once backrest is removed, store crotch strap in bottom of base (p. 40).

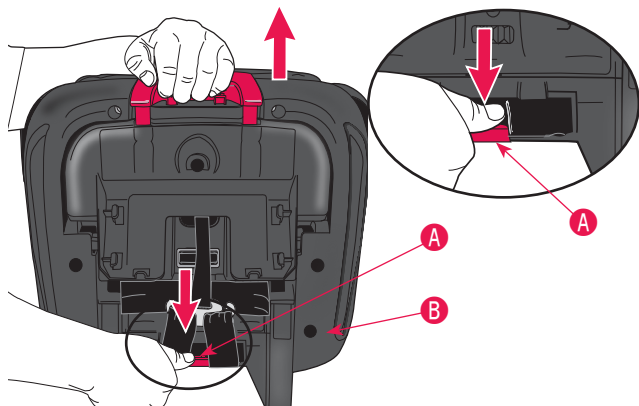

⚠ WARNING

- **DO NOT** use the recline stand in booster mode. The recline stand can only be used with the 5-point harness.

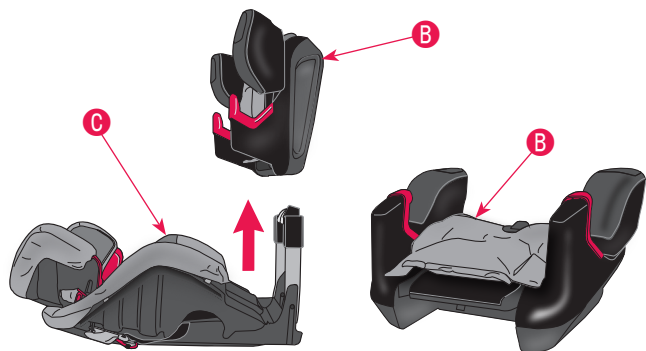

IMPORTANT

Store the backrest properly when not in use and do not leave in the vehicle (other than in trunk). Any loose objects can become projectiles and injure someone during a crash.

Using the Shoulder Belt Clip

1. Attach shoulder belt clip as shown.



For Canadian Models ONLY

2. Attach no-back booster insert.

Slide no-back booster insert **D** into back of base **B** until it snaps into place, as shown.

Note: If you are using the shoulder belt clip, make sure the strap is pulled tight before attaching the no-back booster insert.

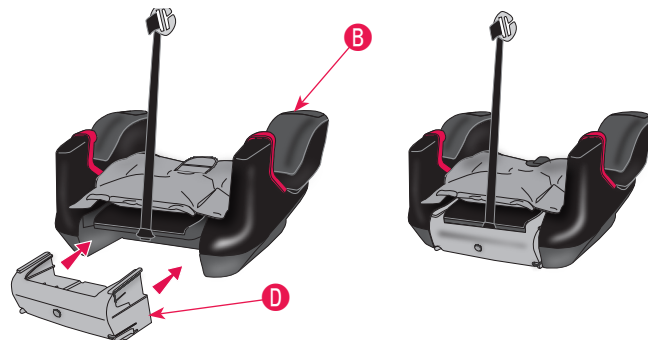

Using the Shoulder Belt Clip

3. Place booster on vehicle seat.

Place booster **B** on the vehicle seat and attach the shoulder belt clip **D** to the vehicle shoulder belt **E**.

4. Adjust shoulder belt clip.

Pull the adjustment strap **F** until the belt clip **D** is even with the child's shoulder, and the vehicle shoulder belt **E** lays across the child's chest midway between his/her shoulder and neck.

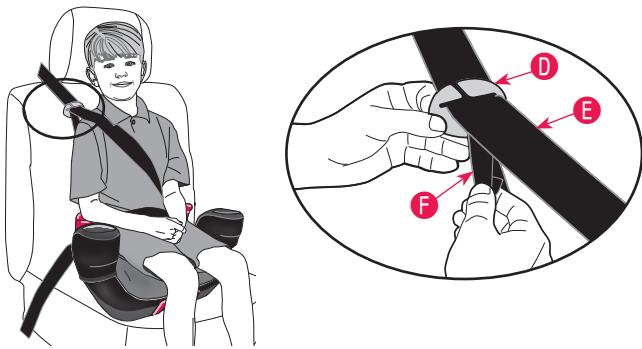

General Information

Reattaching the Backrest

1. Remove seat pad from backrest (see page 53).

2. Unfasten Chest Clip.

Unfasten chest clip from behind backrest and pull harness straps to front of child restraint.

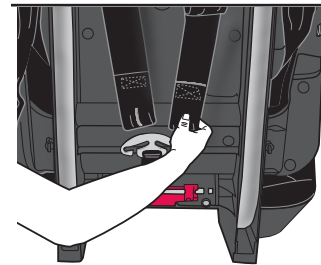
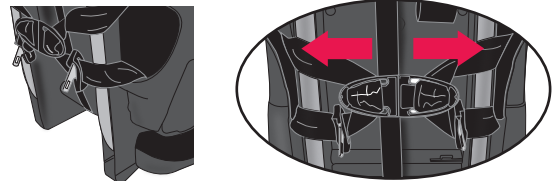

3. Remove both harness straps from the splitter plate on the back of the child restraint.

4. Reattach the seat pad to the backrest.

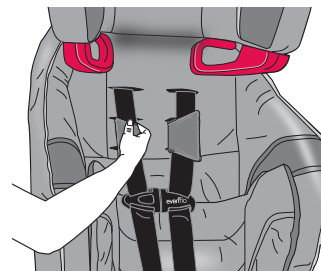

5. Route harness straps.

Route the harness straps through the slots on the front of the child restraint. Pull the harness straps to the back of the child restraint.

Note: Straps must be positioned at the child's shoulder level or slightly above. Harness Covers **MUST** be installed when using the 5-point harness for children weighing 18 kg (40 lbs) or less (see page 54).

IMPORTANT: When inserting harness straps through the slots in the seat pad, make sure you route them correctly through their corresponding slots in the seat shell.

Reattaching the Backrest

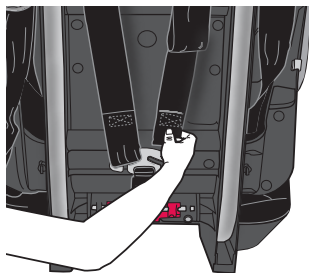

6. Attach harness straps to splitter plate.

Attach the loop at the end of each harness strap onto the splitter plate.



IMPORTANT: Make sure both harness straps are installed **completely** on the splitter plate, as shown.

7. Lay the backrest on its back, as shown.

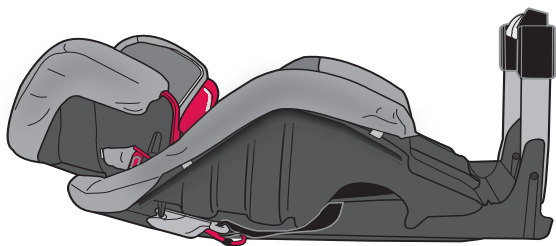

For Canadian Models ONLY

8. Remove no-back booster insert from base.

Push in both tabs **A** on sides of no-back booster insert and slide insert out of base, as shown.

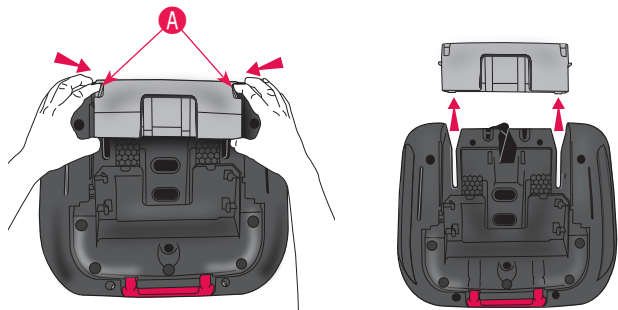

Reattaching the Backrest

9. Remove shoulder belt clip.

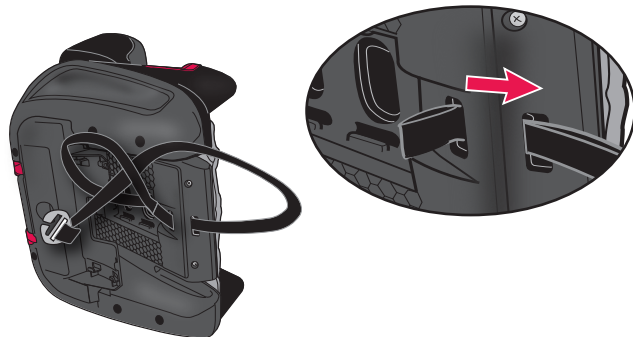

10. Remove crotch strap from bottom of base.

Turn crotch strap anchor sideways and push it through the seat shell to remove, as shown.

Note: Remove seat pad from base for easier access (see page 53).

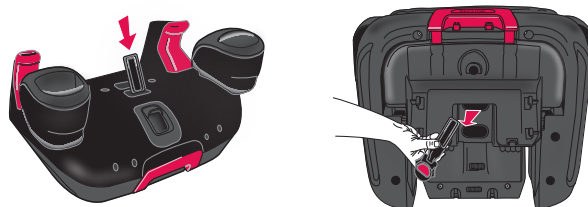

Reattaching the Backrest

11. Insert buckle tongues into the crotch buckle.

Insert the buckle tongues into the crotch buckle, then lay the crotch strap in the seat, as shown.

12. Pull harness adjuster strap to remove slack.

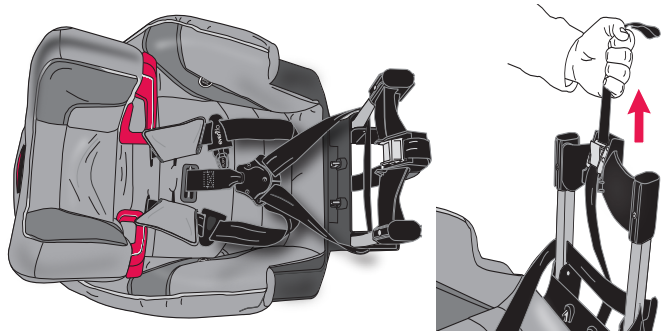

13. Position the base over the backrest.

Position the base **B** over the backrest **C**. Make sure harness adjuster strap **D** is threaded through the opening on the front of base, as shown.

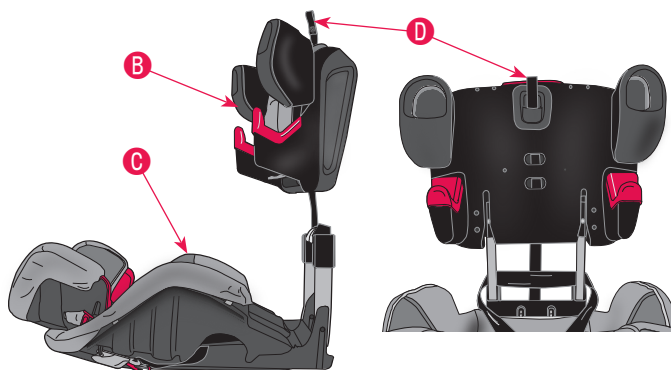

Reattaching the Backrest

14. Push the base onto the backrest.

Push base **B** onto backrest **C** until it snaps into place.

Note: Harness straps **E** must slide into slots **F** toward back of base. Make sure harness straps are not twisted.

IMPORTANT: Pull forward and up on the base to ensure it is securely fastened to the backrest.

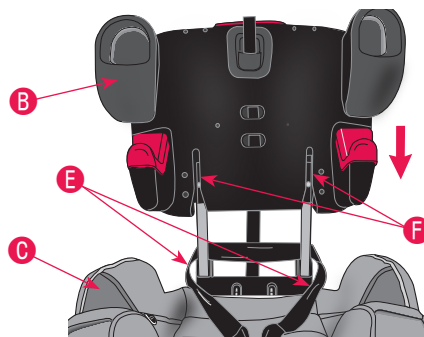

15. Reconnect seat pad to base.

Reconnect seat pad to base, then insert crotch strap anchor into the correct slot in base (see page 33).



Your child restraint is now in 5-point harness mode and ready for a child who meets the following requirements:

- **Weight:** 10 – 29.4 kg (22 – 65 lbs)
- **Height:** 71 – 127 cm (28 – 50 in.) and tops of the child's ears are at or below the top of child restraint headrest
- **Age:** At least 2 years old

Note: Refer to *Installation Checklist* on page 15 for proper installation.

Adjusting the Headrest

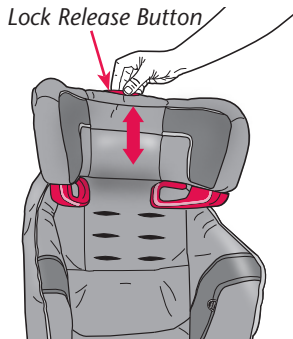

Press the lock release button, as shown, while sliding the headrest up or down to the desired position.

IMPORTANT: When the headrest is in one of the locking positions, the lock release button will pop into its original position.

Adjusting the Recline Position

⚠ WARNING

- The recline stand **MUST** be used for children weighing less than 18 kg (40 lbs).
- **DO NOT** use the recline stand in booster mode. The recline stand can only be used with the 5-point harness.

To recline the base, tilt the child restraint back, then pull the recline handle **A** to release the recline stand **B**.

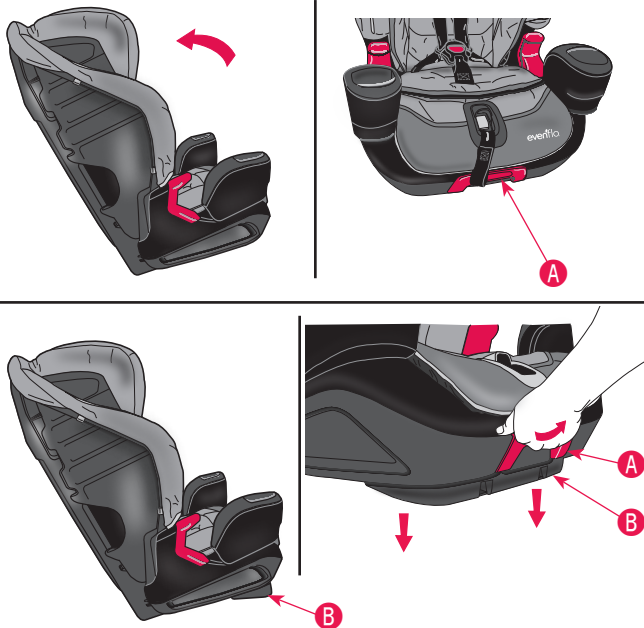

Buckle Tongue Storage

To easily remove your child, unbuckle the crotch buckle and insert the buckle tongues into the buckle tongue holders **A** on each side of the restraint. *Not available on all models.*

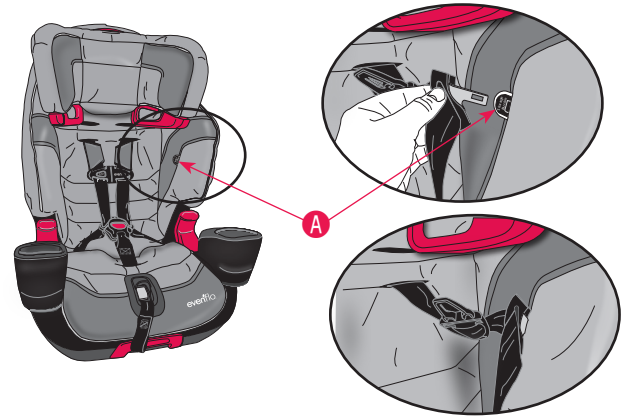

Removing Seat Pad

1. Disconnect the harness straps from the splitter plate on the back of the child restraint.
2. Disconnect all J-clips and all retaining strips. Remove the seat pad.

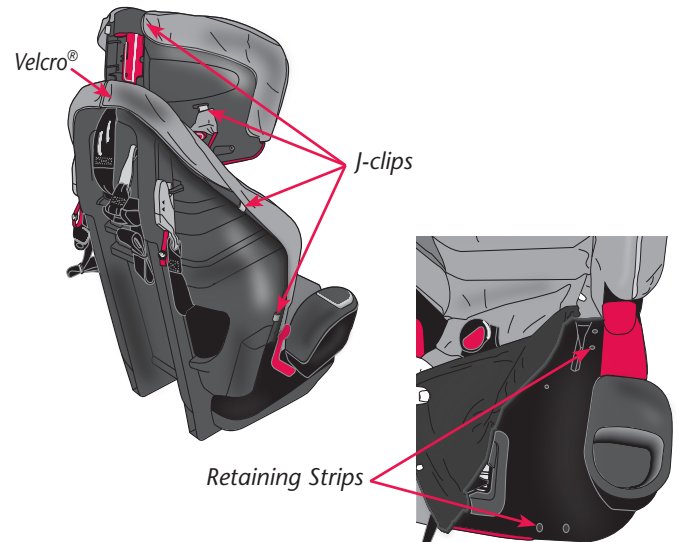

Installing the Accessories

Not available on all models. Styles may vary.

⚠ WARNING

- **DO NOT** use the optional Body Pillow with children weighing more than 18 kg (40 lbs).



The optional Body Pillow **A**, when placed in the restraint, as shown, helps support your child.

⚠ WARNING

- Harness Covers **MUST** be installed when using the 5-point harness for children weighing 18 kg (40 lbs) or less.

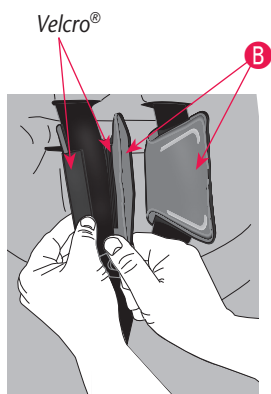

Install Harness Covers **B** above Chest Clip **C** for added comfort. Wrap Harness Covers around harness straps and attach Velcro strips as shown.

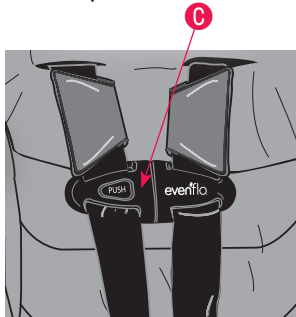

Care and Cleaning

- **DO NOT** lubricate or immerse in water the LATCH connectors, the buckle, or any other part of this child restraint, unless rinsing is permitted, as stated on the back of the buckle for your restraint.
- Plastic and metal parts may be wiped clean with mild soap and water and dried with a soft cloth. Do not use abrasive cleaners or solvents.
- Take care not to damage any labels.
- The harness can be wiped clean with mild soap and water. Allow harness to air dry.
- Machine wash the seat pad separately in cold water, delicate cycle. Tumble dry 10 to 15 minutes on low heat.
- **NEVER** use child restraint without the seat pad.
- To protect the child restraint from damage caused by weather, rodents, and other elements common to garages, the outdoors, and other storage locations, remove the seat pad and thoroughly clean the restraint and pad prior to storage. Take care to clean in the areas where crumbs and other debris tend to accumulate.

Tip! To help protect the vehicle upholstery, place a towel beneath and behind the child restraint.

Proper Disposal of This Child Restraint

At the end of this child restraint's useful life, Evenflo encourages you to dispose of it properly. Most of the components in this child restraint are recyclable.

1. Remove all fabric and padding.
2. Remove all screws and disassemble the restraint.
3. Recycle all plastic/foam parts and discard the rest.

If your local recycling center won't accept the padding, you may dispose of it in the landfill.

Note: Evenflo uses recycled materials in the manufacturing process whenever possible but never for components that are critical for safety.

Securing Your Child Restraint in Aircraft

The Federal Aviation Administration (FAA) recommends that you secure your child for air travel in an appropriate child restraint based on your child's weight and size. Turbulence can happen with little or no warning. When turbulence occurs, **the safest place for your child is in a properly installed child restraint, not in an adult's lap or on the aircraft seat with its seat belt.** Keeping your child in a child restraint during the flight will help ensure your family arrives safely at your destination.

The FAA recommends that a child weighing:

- more than 18 kg (40 lbs) use an aircraft seat belt;
- less than 9 kg (20 lbs) use a rear-facing child restraint; and
- from 9 to 18 kg (20 to 40 lbs) use a forward-facing child restraint.

Please note that these FAA recommendations may vary from those applicable to the use of your child restraint in a motor vehicle.

IMPORTANT

This child restraint can only be used with a 5-point harness in aircraft. This restraint cannot be used in booster mode in aircraft.

Installing Child Restraint in Aircraft

IMPORTANT: Before installing the child restraint, make sure the **aircraft seat is in a fully upright position.**

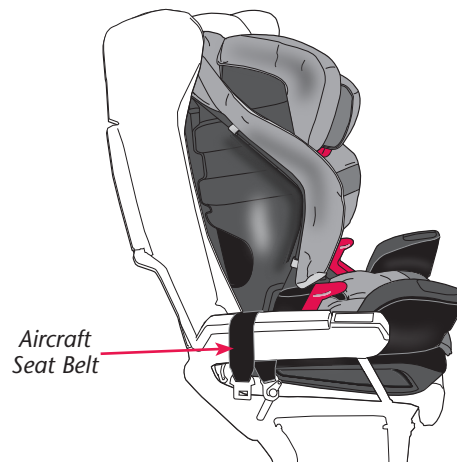

1. Place the child restraint in position.

Place the child restraint on the aircraft seat forward-facing, as shown above.

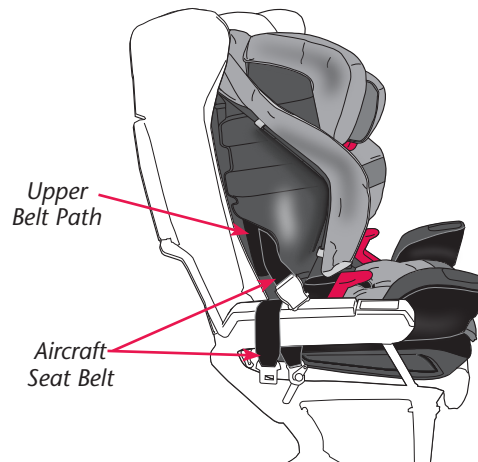

2. Route aircraft seat belt through Upper Belt Path.

Route the aircraft seat belt through the upper belt path opening in the back of the child restraint and continue through the opening on the opposite side of the child restraint.

Note: Lift the restraint's seat pad away for easier access.

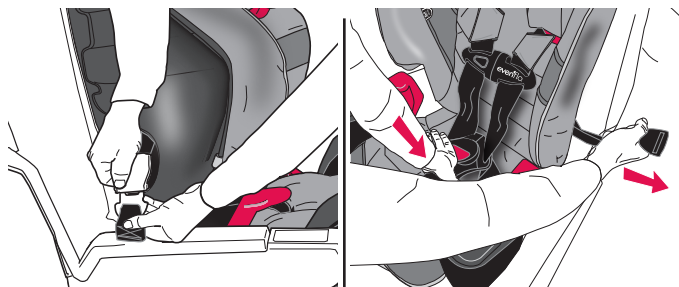

3. Fasten the aircraft seat belt, then remove all slack from the belt.

The aircraft seat belt must be as tight as possible. Route the excess aircraft seat belt strap back through the belt path opening. Using your full weight, push the child restraint firmly onto the aircraft seat while pulling on the excess seat belt strap to tighten.

Note: Because of the fixed length of aircraft seat belts, the belt buckle could be behind the child's back after tightening the belt. For your child's comfort, Evenflo recommends cushioning the child's back by placing a small pillow or folded-up blanket or jacket, over the belt buckle.

Check your work: Reconnect the seat pad to the child restraint. Try to move the child restraint in all directions. If you can move the restraint more than 25 mm (1 in.) from side to side or front to back **at the upper belt path**, the aircraft seat belt is not tight enough, and you **MUST** install again until the seat belt is tight.

4. Secure Your Child in the Child Restraint.

Refer to page 26.

Replacement Parts

Not available on all models. Styles may vary.

You can order replacement parts on-line at www.evenflo.com or contact ParentLink at 1-800-233-5921. When you contact us, please have the product model number and date of manufacture (found on the bottom of the child restraint).



Locking Clip
(Not included with child restraint), see page 24



Chest Clip



Head Foam

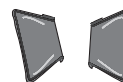

Harness Covers

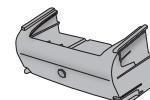

No-Back Booster Insert
(Canada Only)

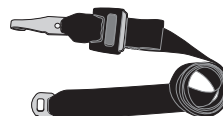

Tether Extender
(Not included with child restraint)

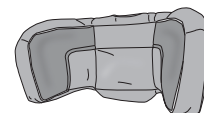

Headrest Pad



Harness System



Shoulder Belt Clip



Seat Pad



Lower Anchor

Or



Quick Connector Lower Anchor

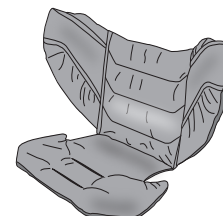

Body Pillow

Limited Warranty

For a period of 90 days from the original purchase of this Product, Evenflo warrants to the original end user (“Purchaser”) this Product (including any accessories) against defects in material or workmanship. Evenflo’s sole obligation under this express limited warranty shall be, at Evenflo’s option, to repair or replace any Product that is determined to be defective by Evenflo and determined to be covered by this warranty.

Repair or replacement as provided under this warranty is the exclusive remedy of the Purchaser. Proof of purchase in the form of a receipted invoice or bill of sale evidencing that the Product is within the warranty period must be presented to obtain warranty service. This express limited warranty is extended by Evenflo ONLY to the original Purchaser of the Product and is not assignable or transferable to subsequent purchasers or end users of the Product. For warranty service, contact Evenflo’s ParentLink Consumer Resource Center at **www.evenflo.com**.

EXCEPT TO THE EXTENT PROHIBITED BY APPLICABLE LAW, ANY IMPLIED WARRANTY OF MERCHANTABILITY OR FITNESS FOR A PARTICULAR PURPOSE ON THIS PRODUCT IS HEREBY DISCLAIMED. EVENFLO SHALL NOT BE LIABLE FOR ANY INCIDENTAL, CONSEQUENTIAL, SPECIAL OR PUNITIVE DAMAGES OF ANY KIND FOR BREACH OF THE EXPRESS LIMITED WARRANTY ON THIS PRODUCT, OR ANY WARRANTY IMPLIED BY OPERATION OF LAW. OTHER THAN THE EXPRESS LIMITED WARRANTY SET FORTH ABOVE, THERE ARE NO OTHER WARRANTIES THAT ACCOMPANY THIS PRODUCT AND ANY ORAL, WRITTEN OR ANY OTHER EXPRESS REPRESENTATION OF ANY KIND IS HEREBY DISCLAIMED.

ParentLink®

answers. advice. affirmation.™

• **www.evenflo.com**

- **USA:** 1-800-233-5921, 8 AM to 5 PM E.T.
- **Canada:** 1-937-773-3971
- **México:** 01-800-706-12-00

ParentLink®

answers. advice. affirmation.™

- **USA:** 1-800-233-5921, 8 AM to 5 PM E.T.
- **Canada:** 1-937-773-3971
- **México:** 01-800-706-12-00