



Extended Warranty  
Sign Up

E-1

# Welcome home!

**CU296**

**TEAMSON HOME  
Outdoor 30-Inch  
Round Steel Wood  
Burning Fire Pit**

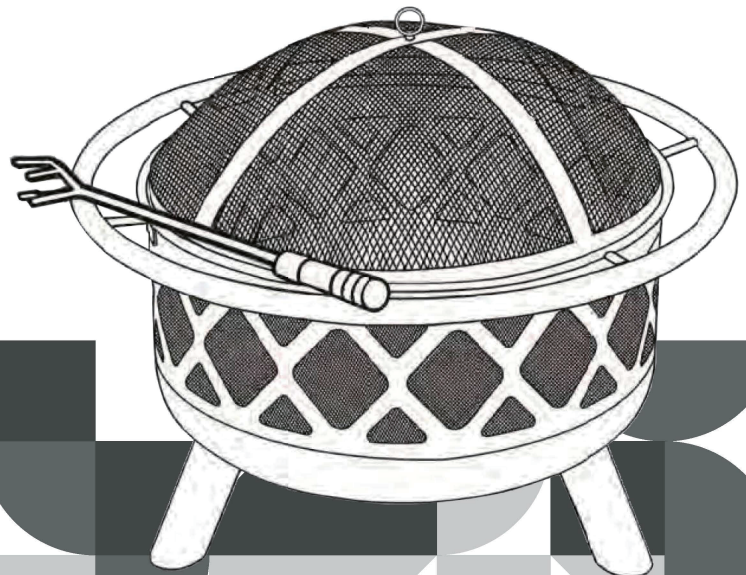

# Warranty

All components are warranted by the manufacturer for a period of 30 days after the date of purchase by the original owner against defects in materials & workmanship under normal use. If it is appropriate to replace your product due to specific defects, the manufacturer will replace the purchase with the same product or a comparable product.

For specific instructions on how to obtain warranty service for your product, please contact Customer Service using the contact information provided.

## Global Customer Service

### USA



✉ [support@teamson.com](mailto:support@teamson.com)

+1(800)935-3959

Mon - Fri 10:00am ~ 2:00pm EST

### EU/UK



✉ [support@teamson.co.uk](mailto:support@teamson.co.uk)

+44(0)1952-916-050

Mon - Thu 9:00am ~ 5:00pm GMT

Friday 9:00am ~ 4:00pm GMT

### ASIA

深圳办公室:

✉ [sales\\_ec@teamson.com](mailto:sales_ec@teamson.com)

+86(0755)8885-3558. 分机号331

Mon - Sat 9:00am ~ 5:00pm GMT+8

台北办公室:



✉ [sales\\_ec@teamson.com](mailto:sales_ec@teamson.com)

+886(2)2556-6268

Mon - Fri 9:00am ~ 5:00pm GMT+8

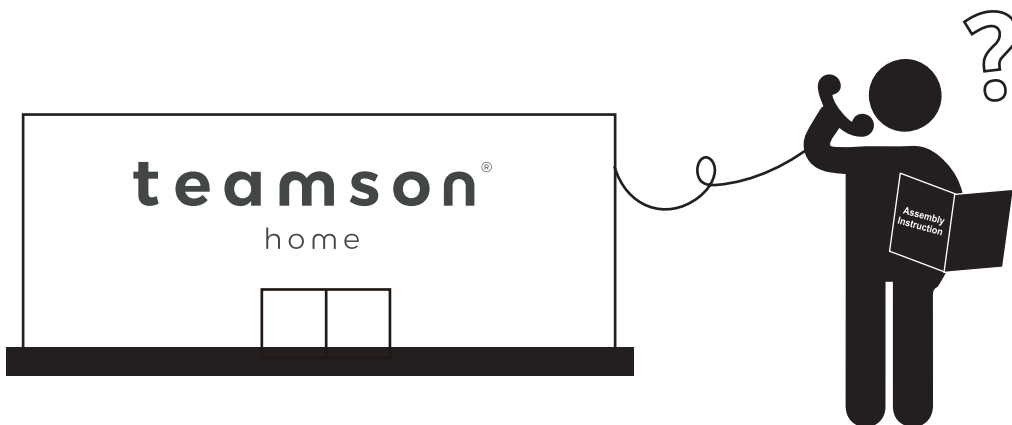
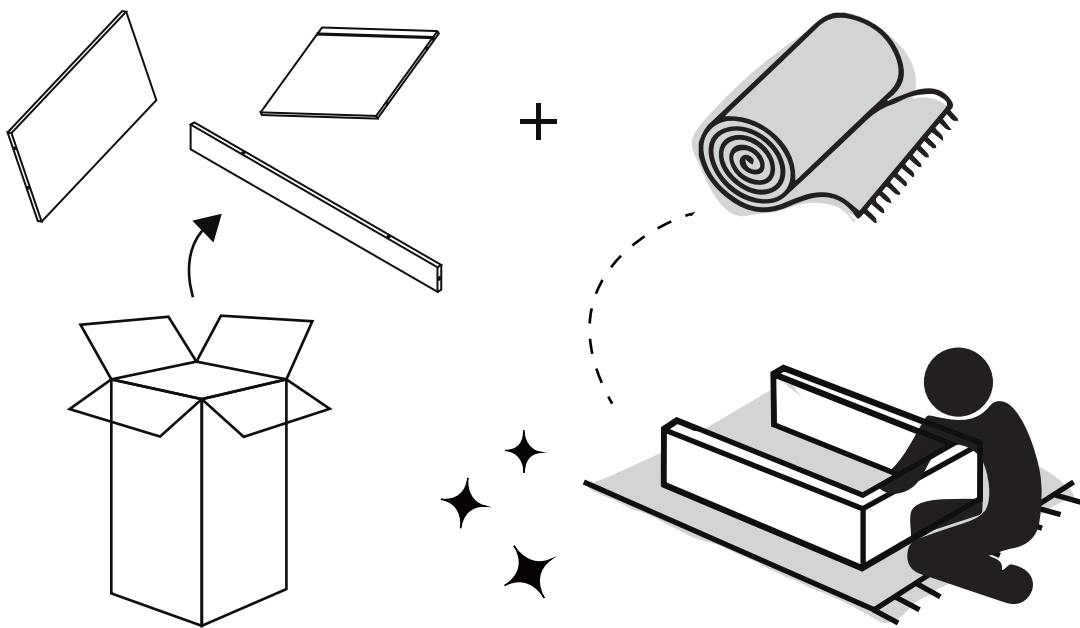
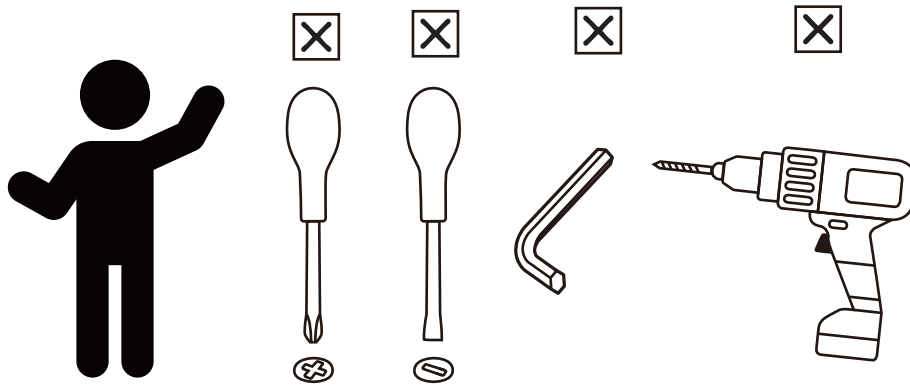

\*\* Got questions? Please have your product code (on the first page of this instruction, e.g. CU296) and the order number ready, give us a call or email us through our customer care support! We are always ready to assist you!

# Warranty

## LIMITATIONS

All components are warranted by the manufacturer for a period of 30 days after the date of purchase by the original owner against defects in materials & workmanship under normal use. If it is appropriate to replace your product due to specific defects, the manufacturer will replace the purchase with the same product or a comparable product.

## GENERAL TERMS & CONDITIONS

1. Proof of purchase is required to request a claim under this warranty.
2. This warranty applies only to manufacturer errors & defects. The warranty applies to the following:
  - a. Breaks and cracks in the product that originated with the manufacturer
  - b. Missing pieces
  - c. Stains that occurred during the manufacturing process
3. This warranty does not apply to the following:
  - a. Damage due to improper loading, handling, or transportation
  - b. Any costs associated with the installation and removal of products or parts subject to this warranty
  - c. Acts of God
  - d. Products which have been subject to negligence, abuse, accident, misapplication, tampering, alteration, or modification
  - e. Products which have been subject to improper installation, operation, maintenance, repair, or storage
  - f. Products which have been subject to defects that occur when this product is used incorrectly and/or outside of normal application purposes
  - g. Products which have had, including but not limited to, operational failures caused by corrosion, rust, or other foreign materials in the system, or operation at pressures in excess of recommended maximums
  - h. All other possible defects not mentioned here that would not have occurred during manufacturing or during correct, routine use of the item

## INSTRUCTIONS

For specific instructions on how to obtain warranty service for your product, please contact Customer Service using the contact information provided. In most circumstances, you will need to return your product either in its original packaging or in equally protective packaging to the address specified by Customer Service.

Before delivering your product for warranty service, it is your responsibility to remove all personal items and belongings you may have stored in your product. Teamson is not responsible for the possible loss, destruction, or damage of any personal items or belongings that have been sent alongside the product.

## DISCLAIMER

Any oral statements made about the product by the seller, the manufacturer, the representatives, or any other parties do not constitute warranties, should not be relied upon by the user, and are not part of the contract for sale. The sellers and manufacturers only obligation, and buyers only remedy shall be for the manufacturer to either replace and /or repair at the manufacturers sole discretion, the product as described above. Neither seller nor the manufacturer shall be liable for any injury, loss or damages for lost profits, lost sales, injury to person or property, or any other incidental or consequential loss arising from any cause whatsoever, no matter whether based upon warranty, contract, negligence or other misuse, and the buyer and user agree that no other remedy shall be available to them. Before using, the buyer and user shall determine the suitability of the product for intended use, and assume all risk and liability whatsoever in connection therewith. The warranty and remedy described in this limited warranty is an exclusive warranty and remedy in lieu of any other warranty or remedy expressed or implied. All other warranties and remedies are hereby expressly excluded, including but not limited to any implied warranty of merchantability of fitness for any particular purpose.

## OTHER LEGAL RIGHTS

This warranty gives the buyer and user specific legal rights, and buyer and user may also have other rights which vary from state to state. Some states do not allow exclusions or limitation of incidental or consequential damages, so the above limitations or exclusions may not apply to you.

## THANK YOU

We appreciate the trust and confidence you have placed in Teamson through the purchase of this product. We strive to continually create quality products designed to enhance your home and life. Visit us online to see our full line of products available for your home décor, toy, and pet needs. Thank you for choosing Teamson!



---

**Scan for assembly  
instructions.**

---



### **⚠ WARNING**

#### **For outdoor use only.**

- Improper installation, adjustment, alteration service or maintenance can cause injury or property damage.
- Read the installation, operation and maintenance instructions thoroughly before installing or servicing this equipment.
- Failure to follow these instructions could result in fire or explosion, which could cause property damage, personal injury or death.

Save these instructions for future reference. If you are assembling this unit for someone else, give this manual to him or her to read and save for future reference.

- This appliance is for outdoor use only, and shall NOT be used in a building, garage, or any other enclosed area.
- Do NOT use this outdoor fire pit for indoor heating. TOXIC carbon monoxide fumes can accumulate and cause asphyxiation.
- This outdoor fire pit is NOT for commercial use.
- This outdoor fire pit is NOT to be operated by children.
- This outdoor fire pit is NOT to be used in or on boats or recreational vehicles.
- Always use in accordance with all applicable local, state and national codes. Contact your local fire department for details on outdoor burning.
- When using this outdoor fire pit, exercise the same precautions you would with any open fire.
- The use of alcohol, prescription or non-prescription drugs may impair the consumer's ability to properly assemble or safely operate this outdoor fire pit.
- Do NOT use this outdoor fire pit without reading the entire "Owner's Manual".
- This outdoor fire pit is for use with dry, seasoned hardwood. It will burn hotter, more completely and create less smoke.
- Do NOT burn manufactured logs, driftwood, trash, leaves, paper, cardboard, plywood, painted or stained or pressure treated wood. Avoid using softwoods such as pine or cedar that can throw sparks.
- Do NOT alter this outdoor fire pit in any manner.
- Do NOT use this outdoor fire pit until it is COMPLETELY assembled and all parts are securely fastened and tightened.
- Do NOT store or use gasoline or other flammable vapors or liquids in the vicinity of this or any other appliance.
- Do NOT store or use an LP gas cylinder within 10 feet (3.05 m) of this outdoor fire pit while it is in operation.
- Do NOT use this outdoor fire pit near automobiles, trucks, vans or recreational vehicles.



---

**Scan for assembly  
instructions.**

---

## Safety Information

- Do NOT use in an explosive atmosphere. Keep outdoor fire pit area clear and free from combustible materials, gasoline and other flammable liquids.
  - Do NOT use this outdoor fire pit under any overhead or near any unprotected combustible constructions. Avoid using near or under overhanging trees and shrubs.
  - Always use this outdoor fire pit on a hard, level non-combustible surface such a concrete, rock or stone. An asphalt or blacktop surface may not be acceptable for this purpose. Do NOT use on wooden decks.
  - Always empty this outdoor fire pit before each use. Leave a thin layer of ash to protect the bottom.
  - Do NOT wear flammable or loose clothing when operating this outdoor fire pit.
  - Do NOT use in windy conditions.
  - Do NOT use this outdoor fire pit unless spark guards are securely in place.
  - Do NOT use gasoline, kerosene, diesel fuel, lighter fluid or alcohol to light or relight fires.
  - Keep all electrical cords away from a hot fire pit.
  - All surfaces of this outdoor fire pit are hot when in operation. To avoid burns, do NOT touch fire pit until it has completely cooled unless you are wearing protective gear (Potholders, gloves, BBQ mittens, hot pads & etc.). Never touch ashes or coals to see if they are hot.
  - Do NOT leave a lit outdoor fire pit unattended, especially around children and pets
  - Do NOT attempt to move or store this outdoor fire pit until all ashes and coals are completely extinguished.
  - Do NOT remove ashes or coals until they are completely and fully extinguished.
  - Use heat-resistant gloves or hot pads when contacting handles.
  - Use long, sturdy fire pit tools when adding or moving logs.
  - Do NOT place wood directly into bottom of the outdoor fire pit. Place wood only on the wood grid.
  - Do NOT overload the fire pit. Do not add additional firewood until the fire burns down.
- NOTICE: If any portion of the bowl, lid or spark guards of this outdoor fire pit are glowing red it is overloaded.
- Do NOT lean over this outdoor fire pit when lighting or when in use.
  - Do NOT place a hot spark guard or hot fire pit tools onto combustible surfaces such as grass, wooden deck or furniture.
  - Avoid breathing smoke from the fire and avoid getting it into your eyes.
  - This outdoor fire pit should be thoroughly inspected and cleaned on a regular basis.
  - After a period of storage and/or non-use, check for signs of damage and creosote build-up. Do NOT operate until necessary repairs and/or cleanup are executed.
  - Deaths, serious injury or damage to property may occur if the above is not followed exactly.



---

**Scan for assembly  
instructions.**

---

## Operating Instructions

Before using this outdoor fire pit, make sure you have read, understand and are following all information provided in the important safeguards presented on page 3. Failure to follow those instructions can cause death, serious injury or property damage.

### Light

- Make sure there is only a small amount of ash in the bottom of the bowl.
- Place a layer of dry kindling or a natural firestarter onto the center of the grate.
- Place above that a layer of dry seasoned hardwood that is cut to lengths no more than 3/4 the diameter of the bowl.
- Use a match to light kindling or firestarter.
- Replace spark arrestor by using the fire tool once the kindling or firestarter is lit.

### Tending the Fire

- You may need to shift and/or add logs for an ideal experience.

### Reminders:

Always wear protective gloves or a pot holder when tending fire.

- Wait until glowing coals have developed before adding any additional wood.
- Do NOT add gasoline, kerosene, diesel fuel, Lighter fluid or alcohol to relight or enhance an existing fire.
- Carefully remove spark arrestor by using the fire tool.
- While using a long handled fireplace tool, shift coals and logs to allow additional airflow.
- If additional wood is required, place wood on top coals. Be careful not to shift ashes
- Replace spark arrestor by using the fire tool.

### Extinguishing

- Allow fire to burn itself out.
- Do NOT use water to extinguish as this is dangerous and can cause damage to this outdoor fire pit.

### Cleaning and Care Inspecting

- This outdoor fire pit should be inspected on a regular basis to ensure product safety and longer product life.

**Do NOT attempt to inspect this outdoor fire pit until the fire is COMPLETELY out.**

- Check handles to make sure they are secure.
- Check components for any signs of damage or rust.
- If damage to any component is detected, do NOT operate until repairs are executed.

### Cleaning

- This outdoor fire pit should be cleaned on a regular basis to promote safer experiences and longer product life. Note: After repeated use, a slight discoloration of the finish may occur.

**Do NOT attempt to clean this outdoor fire pit until the fire is COMPLETELY out.**

**Do NOT use oven cleaner or abrasive cleaners as they will damage this product.**

**Do NOT clean any part of this outdoor fire pit in a self cleaning oven as it may damage the finish.**

- Wipe exterior surfaces with a mild dishwashing detergent or baking soda.
- For stubborn surfaces use a citrus based degreaser and a nylon scrubbing brush.
- Rinse clean with water
- Remove built-up creosote from components with a chimney cleaning product.

### Storage

Do NOT move or store this outdoor fire pit until the fire is COMPLETELY out.

- Once the fire is out, coals are cold and outdoor fire pit is cool to the touch, remove ashes and properly dispose.

- Store assembled in a location away from children and pets.

**Note: If you do not use a cover, store this outdoor fire pit in a dry location to maximize product life.**



**Scan for assembly instructions.**

## Product Parts

A



Mesh Spark  
Guard Handle  
1PC

B



Mesh Screen  
1PC

C



Fire Bowl  
1PC

D



Leg  
3PCS

E



Poker  
1PC

F

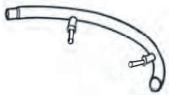

A Fence Tube  
4PCS

G

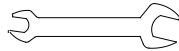

Wrench  
1PC

H



Nut M6  
9PCS

I



M6 Washer  
9PCS

J



M8 Washer  
6PCS

K



Nut M8  
6PCS

### ⚠ WARNING:

1. Do not let any sharp objects touch or rub the surface of the product.
2. When assembling, do not let children play around the working area.
3. Please confirm all parts are correct before starting the assembly process.
4. Do not tighten all bolts and screws completely until the entire unit has been assembled and set up.



Scan for assembly  
instructions.

# Assembly

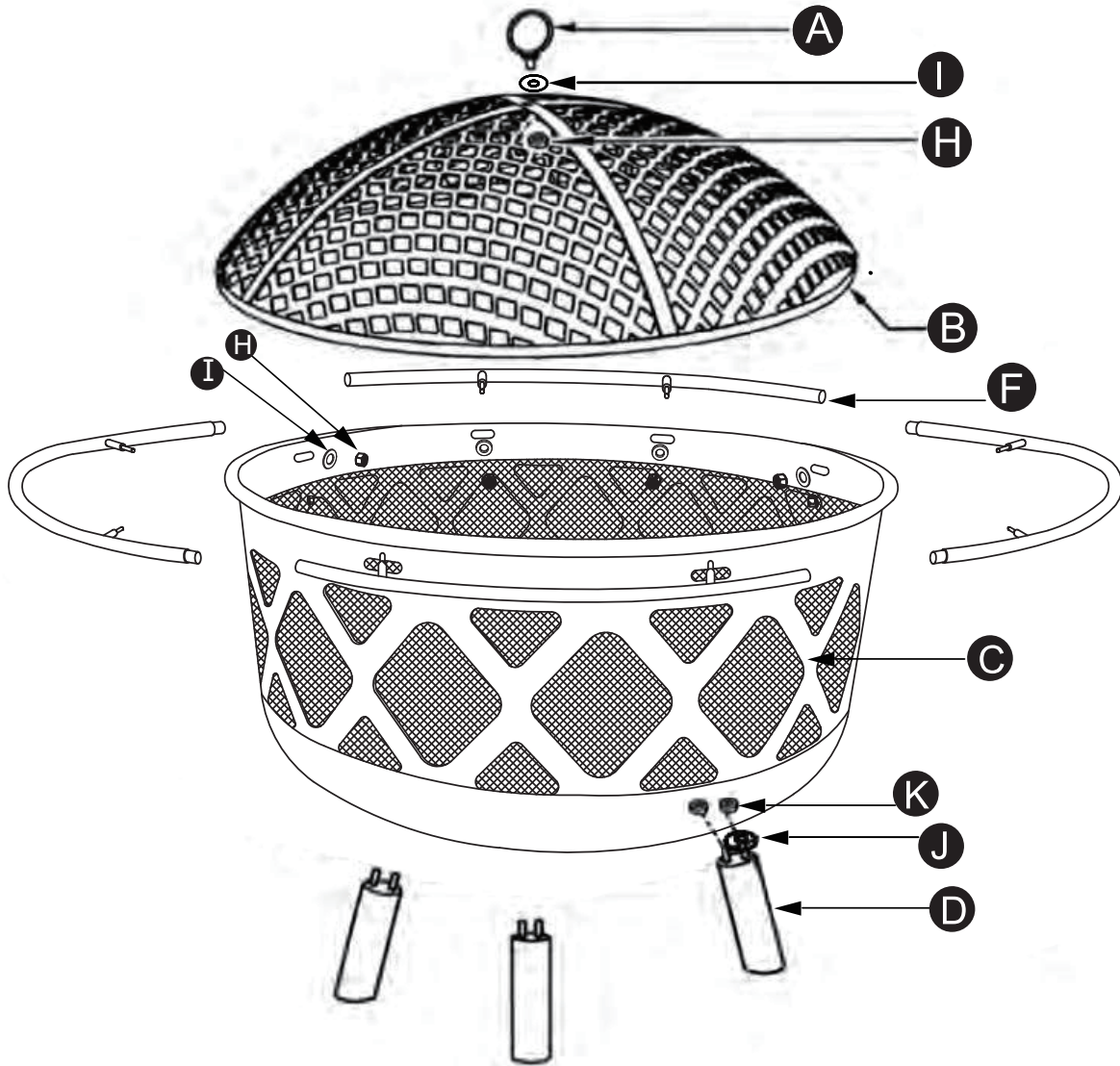

Scan for assembly instructions.