

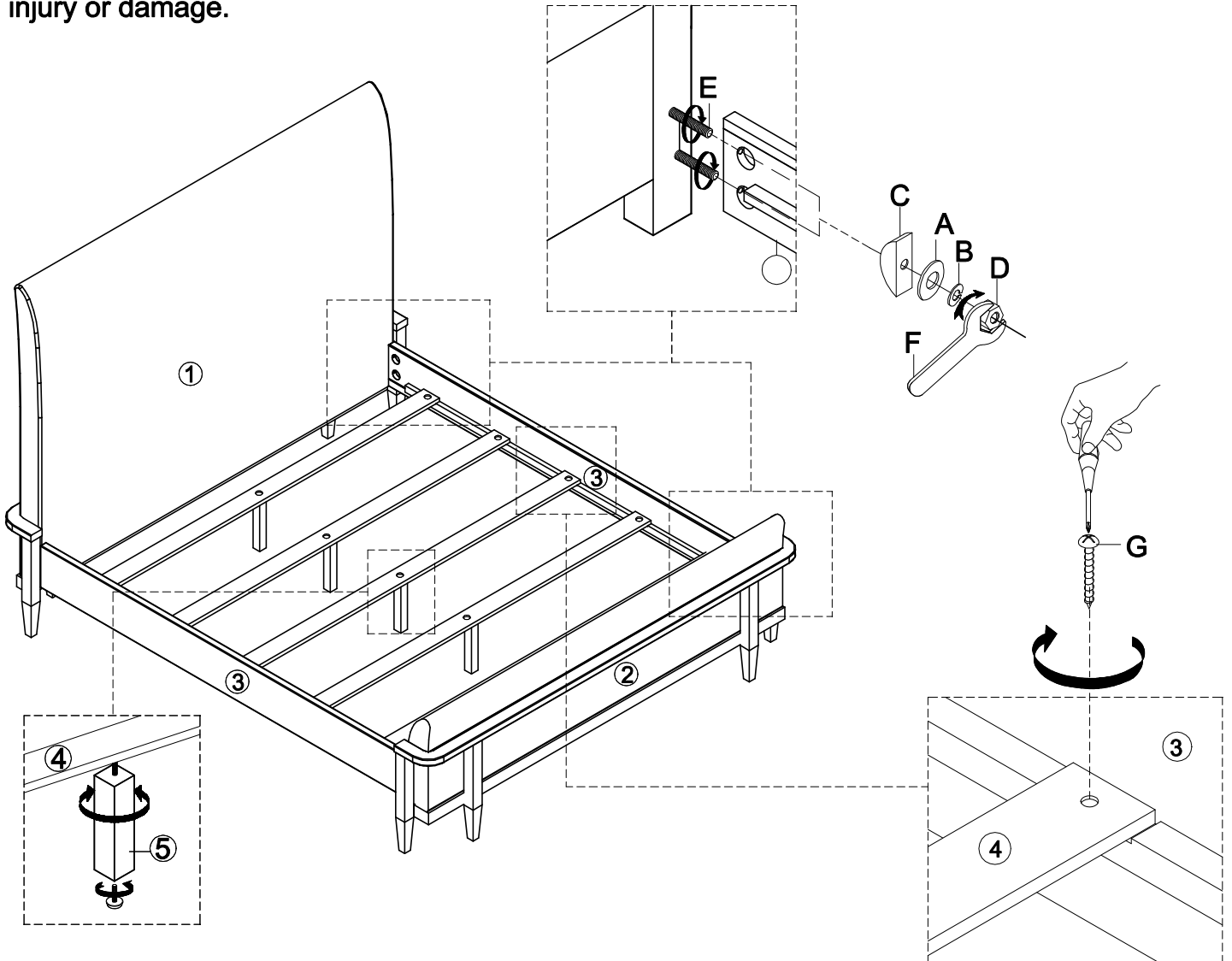











Thank you for purchasing this quality product from A.R.T. Furniture. Be sure to check all packing material for parts which may have come loose inside the carton during shipment. Identify and count all parts and compare with the parts list below.

Note: Some furniture is heavy, it is recommended that two people assembly this item to avoid injury or damage.



| No. | Hardware List | | Qt. |
|-----|---|-----------------------|-----|
| A |  | Flat Washer | 8 |
| B |  | Lock Washer | 8 |
| C |  | Half Round Washer | 8 |
| D |  | Nut (5/16") | 8 |
| E |  | Bolt (5/16" x 3-5/8") | 8 |
| F |  | Wrench | 1 |
| G |  | Wood Screw | 10 |

| Parts List | | | |
|------------|---|---------------|---|
| 1 |  | Headboard | 1 |
| 2 |  | Footboard | 1 |
| 3 |  | Side Rail | 2 |
| 4 |  | Slats | 5 |
| 5 |  | Slats Support | 5 |