

Models/Modelos/Modèles
594-DST & 794-DST
 Series/Series/Seria
Linden™

For models produced after 03/06/2022, see page 1 & 2.
 For models produced prior to 03/06/2022 see page 3 & 4.
 Para los modelos producidos después del 06/03/2022, consulte la página 1 y 2.
 Para los modelos fabricados antes del 06/03/2022, consulte la página 3 y 4.
 Pour les modèles produits après le 06/03/2022, voir page 1 et 2.
 Pour les modèles produits avant le 06/03/2022 voir page 3 et 4.

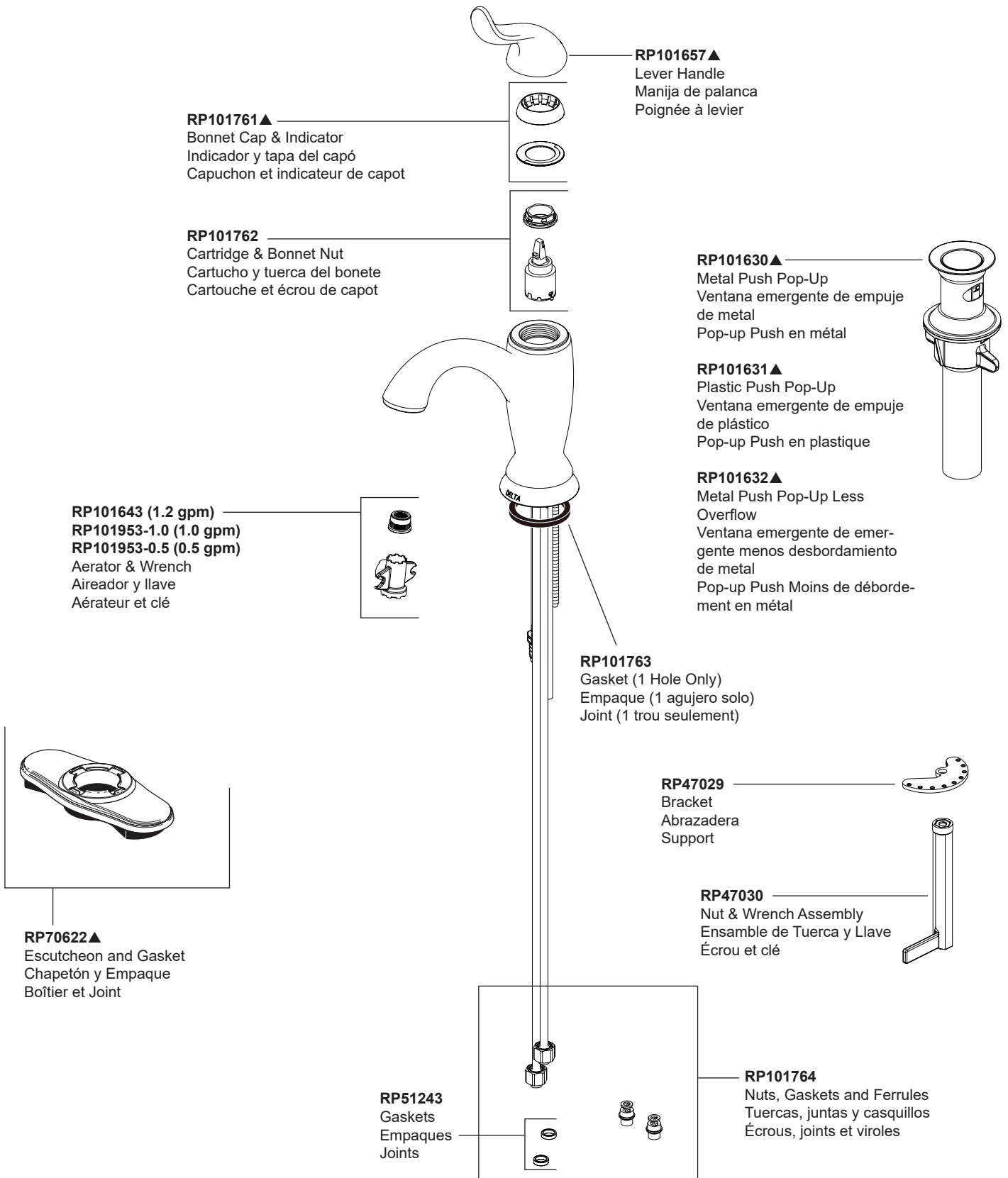

▲Specify Finish / Especificque el Acabado / Précisez le Fini

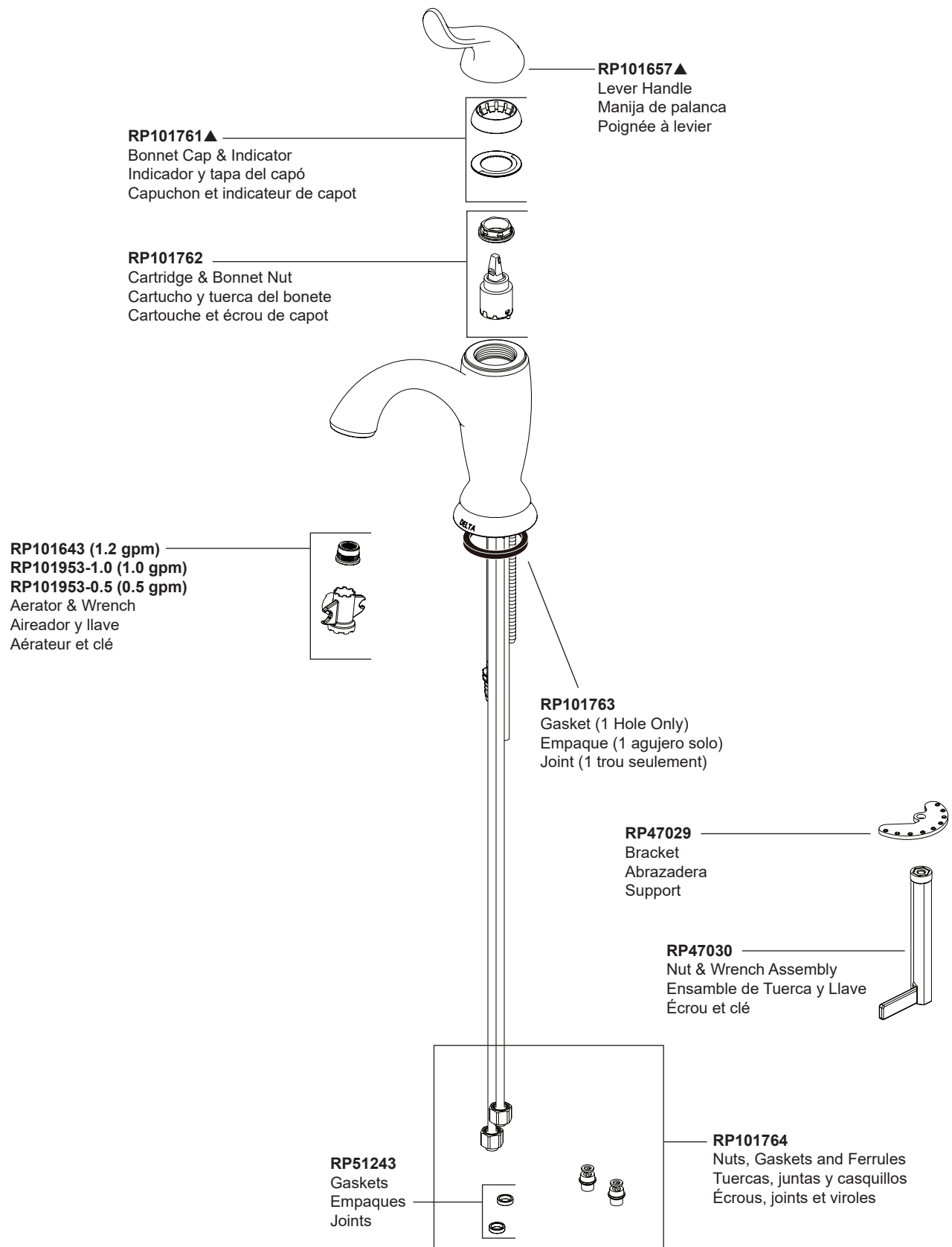

▲Specify Finish / Especificque el Acabado / Précisez le Fini

Models/Modelos/Modèles
594-DST & 794-DST
 Series/Series/Seria
Linden™

RP70622▲
 Escutcheon with
 Gasket (3 Hole)
 Chapetón y
 Empaque (3 agujeros)
 Boîtier et Joint (3 trous)

▲Specify Finish
 Especificque el Acabado
 Précisez le Fini

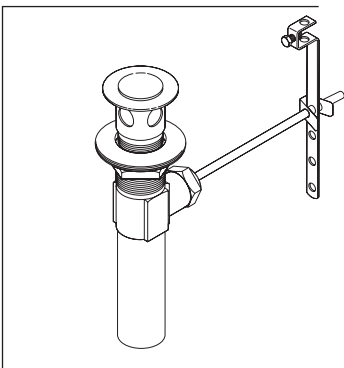
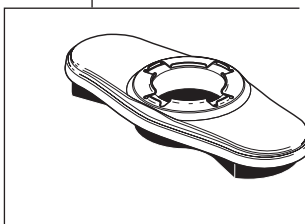

RP26533▲
 Metal Pop-Up Assembly Less Lift Rod
 Ensamble de Metal del Desagüe
 Automático Sin la Barra de Alzar
 Renvoi Mécanique en Métal Sans
 la Tige de Manoeuvre

RP63263
 Adapters
 3/8"-24 UNEF to 1/2"-20 UN &
 3/8"-24 UNEF to 1/2"-14 NPSM

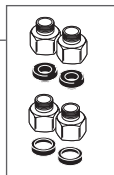

Adaptadors
 3/8"-24 UNEF a 1/2"-20 UN &
 3/8"-24 UNEF a 1/2"-14 NPSM

Adapteurs
 3/8 po-24 UNEF à 1/2 po-20 UN et
 3/8 po-24 UNEF à 1/2 po-14 NPSM

RP63264
 Adapters (10) 3/8"-24 UNEF to 1/2"-20 UN
 Adaptadors (10) 3/8"-24 UNEF a 1/2"-20 UN
 Adapteurs (10) 3/8 po-24 UNEF à 1/2 po-20 UN

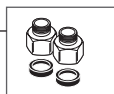

RP63265
 Adapters (10) 3/8"-24 UNEF to 1/2"-14 NPSM
 Adaptadors (10) 3/8"-24 UNEF a 1/2"-14 NPSM
 Adapteurs (10) 3/8 po-24 UNEF à 1/2 po-14 NPSM



RP70623▲
 Handle, Red/Blue Button
 & Set Screw
 Manija, Botón Rojo/Azul
 y Tornillo de Ajuste
 Manette, Bouton Rouge/
 Bleu et Vis de Calage

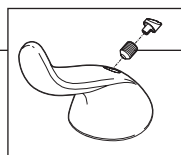

RP37036
 Set Screw
 Tornillo de Ajuste
 Vis de calage

RP54975
 O-Ring
 Anillo O
 Joint torique



RP54972▲
 Cap
 Casquillo
 Embase



RP54976
 Bonnet
 Bonete
 Chapeau

RP50587
 Valve Assembly
 Ensamble de la válvula
 Soupape



RP52216
RP52216-1.2
 Aerator
 Aereador
 Aérateur



RP52217
 Wrench
 Llave
 Clé

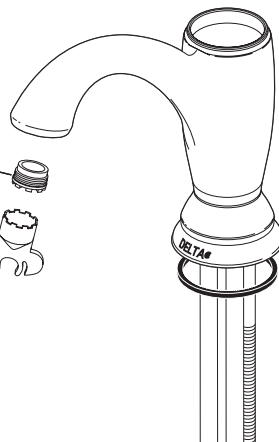

RP47029
 Bracket
 Abrazadera
 Support

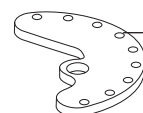

RP47030
 Nut & Wrench Assembly
 Ensamble de Tuerca y Llave
 Écrou et clé

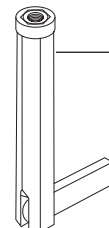

RP50952
 Plastic Sleeves
 Mangas Plásticas
 Manchons en plastique



RP51243
 Gaskets
 Empaques
 Joints



▲ Specify Finish
Especifique el Acabado
Précisez le Fini

RP70623 ▲
Handle, Button & Set Screw
Manija, Botón I y Tornillo de Ajuste
Manette, Bouton et Vis de Calage

RP37036
Set Screw
Tornillo de Ajuste
Vis de calage

RP54975
O-Ring
Anillo O
Joint torique

RP54972 ▲
Cap
Casquillo
Embase

RP54976
Bonnet
Bonete
Chapeau

RP50587
Valve Assembly
Ensamble de la válvula
Soupape

RP54977
RP54977-1.2
Aerator & Wrench
Aerador y Llave
Aérateur et Clé

RP52217
Wrench
Llave
Clé

RP63263
Adapters
3/8"-24 UNEF to 1/2"-20 UN &
3/8"-24 UNEF to 1/2"-14 NPSM
Adaptadors
3/8"-24 UNEF a 1/2"-20 UN &
3/8"-24 UNEF a 1/2"-14 NPSM
Adaptateurs
3/8 po-24 UNEF à 1/2 po-20 UN et
3/8 po-24 UNEF à 1/2 po-14 NPSM

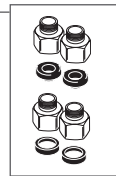

RP63264
Adapters (10) 3/8"-24 UNEF to 1/2"-20 UN
Adaptadors (10) 3/8"-24 UNEF a 1/2"-20 UN
Adaptateurs (10) 3/8 po-24 UNEF à 1/2 po-20 UN



RP63265
Adapters (10) 3/8"-24 UNEF to 1/2"-14 NPSM
Adaptadors (10) 3/8"-24 UNEF a 1/2"-14 NPSM
Adaptateurs (10) 3/8 po-24 UNEF à 1/2 po-14 NPSM



RP51243
Gaskets
Empaques
Joints

RP47029
Bracket
Abrazadera
Support

RP47030
Nut & Wrench Assembly
Ensamble de Tuerca y Llave
Écrou et clé

RP50952
Plastic Sleeves
Mangas Plásticas
Manchons en plastique