

User's Manual

BV9BA

**9" WIDESCREEN FLIP-DOWN
TFT MONITOR
WITH BUILT-IN DVD PLAYER**

BV9BA

**9" WIDESCREEN FLIP-DOWN
TFT MONITOR
WITH BUILT-IN DVD PLAYER**

12.2010



tech support: www.bossaudio.com/support

BOSS[®]
AUDIO SYSTEMS

BOSS Audio Systems
3451 Lunar Court • Oxnard, CA 93030
www.bossaudio.com
800.999.1236

BOSS[®]
AUDIO SYSTEMS

Contents

A. Precautions01	N. Function of Buttons 12
B. Notice before operation 02	POWER.....12
C. Accessories03	Cover opening 12
D. Features04	PLAY/PAUSE12
E. Video disk type 04	Fast forward/fast backward12
F. System connection and installation 05	PREV/NEXT..... 12
G. Button parts in front of the player 06	STOP/RETURN..... 12
H. Button parts at back of the player 07	SLOW..... 13
I. Battery installation for remote controller 08	PROGRAM..... 13
J. Precautions for remote controller 09	REPEAT..... 13
K. Application of remote controller 09	ROOT MENU/PBC.....13
L. Description for pressing Buttons of remote controller 10	DISPLAY..... 14
M. Basic operations 11	MUTE..... 14
Power ON/OFF..... 11	ZOOM..... 15
Disk loading..... 11	GOTO.....15
Disk removing..... 11	SCREEN.....15
USB and card reading.....11	SUBTITLE.....15
	TITLE MENU..... 15

R. Technical specifications and parameters

Product Name	AUTOMOBILE FLIP-DOWN DVD PLAYER
Disk type (signal source)	MP4/MP3/ DVD/SVCD/VCD/DVCD/CD/CDG/WMA/JPEG CD-R/CD-RW (these two types of disk should be played by the above coding formats)
Display	color TFT 16:9 (Optional 8.5 or 9 inch)
Output Port	Audio: stereo Video: complex video signal output (AV) USB port (for spare) MS/MMC/SD CARD PORT (for spare)
Video System	PAL/NTSC/Auto
Video Characteristics	Video Characteristics: 1.0Vp-p (75ohm)
Audio Characteristics	Frequency characteristics: 20-20KHZ (1dB) SNR: >90dB Total harmonic distortion: <0.01%
Power Voltage	DC: 12V/1.5A
Power Consumption	About: 12W
Working Temperature	-40 °C ~ +60 °C
Working Humidity	15~75% (No water drop is coagulated)
Net Weight	Approx.2kg
Dimensions	(L)257mm X (W)239mm X (d)49mm

VOLUME UP/DOWN.....	16	LANGUAGE SETUP.....	21
MENU SETUP.....	16	1. DISPLAY LANGUAGE.....	21
DIRECTION Button.....	16	2. Audio/Subtitle/menu language... 21	
MEDIA.....	16	AUDIO SETUP.....	22
CHANNEL/Language.....	16	TONE	22
Number Button and 10+ Button... 17		P. Description for playing of disks 23	
Video switch Button.....	17	Playing Mp3 & JPEG disks.....	24
IR A/B Button.....	17	Disks available for this player	25
Image function Button.....	17	MPEG4 decoding technology.....	25
FM Transmitting.....	17	Q. Troubleshooting 26	
0. Menu operation 18		R. Technical specifications 27	
SYSTEM SETUP	18		
1. TV SYSTEM.....	18		
2. TV TYPE.....	19		
3. PASSWORD and RATING.....	19		
4. DEFAULT	20		

A. Precautions

Thank you for purchasing our product, please read the operation instruction carefully prior to operation so as to use the player correctly, and please keep it appropriately for future reference.

Warning

- For the sake of your safety, do not watch the video image or open the display while driving.
- Any modifications to the unit by unauthorized personnel could cause malfunctions and will void warranty

Caution

- Dangerous High Voltages inside, do not open
- LCD monitor is fragile, please use caution when handling
- Do not use chemicals to clean the unit, use only a soft cloth dampened with water if necessary
- This unit is designed to be used on 12V negative ground systems only. Electrical systems other than this may damage unit.
- Danger, Invisible LASER radiation inside. To be opened by authorized service personnel only

Special Tips

- In using, the LCD might have a few bright spots on its screen, which is a very normal phenomenon in the active matrix display technology, and it doesn't mean the product has any fault or trouble.

Q. Troubleshooting

Troubles	Solutions
No response	1. Check the power connection; 2. Check the auto power is opened; 3. Check the power is opened.
No sound	1. Check whether the volume is on the Min. position or in Mute state; 2. Whether it's in FM state? Switch it to be FM OFF state by pressing the FM key on remote controller or panel; 3. No sound output in the following states: Pause/Fast Forward/Fast Backward/Stop.
Image	1. Check whether the player is in line input state, press DVD/AV to switch it to be DVD state; 2. Check whether the brightness setup is appropriate.
The disk couldn't be read	1. Check whether the disk has been loaded and the side with label is placed upward; 2. The disk is damaged or dirtied, please load another disk or clean the disk; 3. The region codes of disk and player are different; 4. The disk format is wrong.
Improper image size	1. Set up the TV system once again; 2. Select the corresponding screen format from the setup menu.
The track couldn't be selected	1. Some sections of some disks are not allowed to interrupt its set playing order.
The remote controller refuses to work	1. Check whether there exists any barrier between the remote controller and player; 2. The remote controller doesn't aim at the receiving head of player; 3. Check whether the battery is installed correctly; 4. Check whether the battery has enough voltage.

Do not dismantle the device to repair without permission!

MPEG4 Decoding Technology

MPEG4 is the widely-applied video image saving and transporting standard. the DVD is designed with MPEG4 file playing function skillfully, the user may not only enjoy the rich video/audio resource on the internet but also breach the limit of watching film on computer only. The user may use PC to download, record or transcribe and produce the MPEG4 disks, the better picture and sound quality could be achieved.

MPEG4 is the fourth version of audio/video standard by Moving Pictures Experts Group. MPEG1 is the video image compression standard of VCD; MPEG2 is the video image compression standard of DVD or super V; MPEG4 is one of the network video image compression standards, the video/audio file with MPEG4 technology features high compression rate and clear image. Generally, hundred or more OK songs or many films might be saved in one disk with better image quality than VCD or SVCD!

Note: in the current market, some disks marked with MPEG4 is Real Video actually or other formats (such as *.rm/*.*.ra/*.*.ram/*.*.rmvb/*.*.wmv/*.*.ast), which couldn't be compatible with the international standard MPEG4, they could be played by special software only and couldn't be played by this player. Do identify it in buying disks.

Description for Playing MP4 Disks

The operation of MP3 disk is same with playing MP4 disk, MP4 disk has video image and auto play is the default setup for this player, press Stop/Return key to return to the menu to facilitate the user to select the menu.

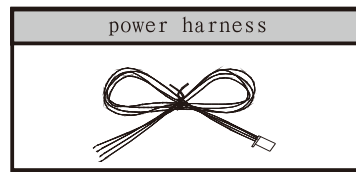
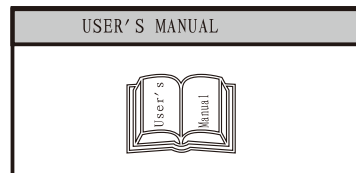
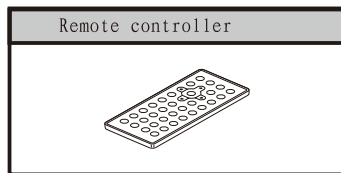
B. Notice before operation

Safety

- Before operating the product, please check the voltage of your car and it should be consistent with the working voltage of the player.
- Do grasp the power plug firmly in connecting or disconnecting to the power, do not pull on wiring harnesses.
- The invisible LASER beam used by the product is harmful to eyes. Unit should be opened by authorized repair technicians only

C. Accessories

Please check the following accessories after opening the package.



Electronic Album

The player features strong electronic album function, the user may record his/her photos in the video disk or external memorizer and browse the photos through the player, what's more, the user may zoom in or out the photo and turn it upward/downward/leftward/rightward, it's unnecessary to worry about the damage or loss of photos.

Playing JPEG Disks

1. Load JPEG disk, it shall stop on the first picture of the first directory after being searched;
2. Use the up/down key to select the picture file, press Play key or confirm to start to play from the selected file;
3. In playing pausing to play picture, you may press the direction key (up/down/left/right) to switch the display angle.

[▲] UP: turn the picture upward
[◀] LEFT: rotate 90 degree leftward

[▼] DOWN: turn the picture horizontally
[▶] RIGHT: rotate 90 degree rightward

Playing MP3 & JPEG Disks

1. In playing MP3 and JPEG mixing disk, if the user wants to browse the pictures in playing MP3, press direction key to move the cursor on the picture to be browsed, press Enter key to enter JPEG browse state.
2. Further press direction key to enter the picture play menu, after selecting one picture in the image directory menu, press Play key to play the pictures in order.
3. Press Left/Right key to switch the state between MP3 and image browse.

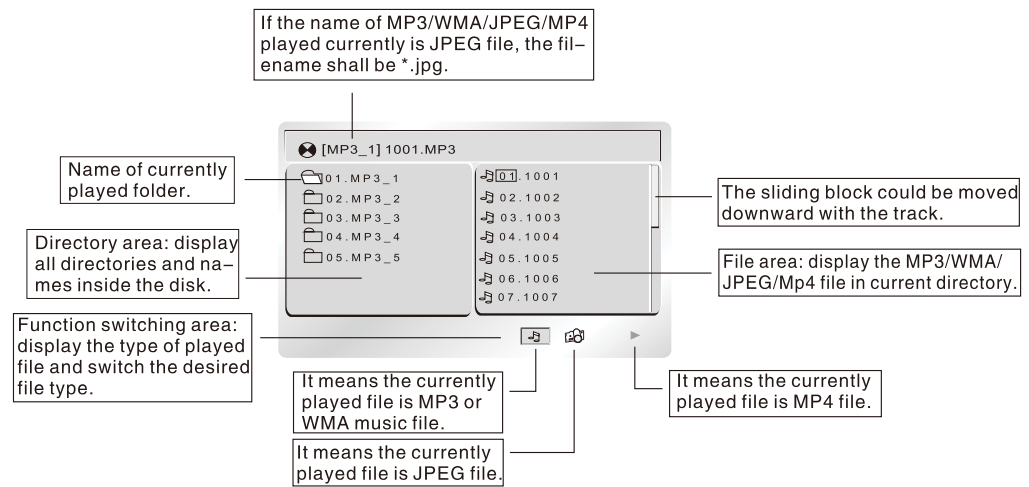
Caution:

- MP3 disk without image has audio signal output only;
- Some JPEG pictures can't be zoomed in depending on the format

P. Description for playing MP4/MP3/WMA/JPEG disks

After loading the MP4/MP3/WMA/JPEG disks, the player shall search the directories automatically, after being searched, it will enter the directory of MP3 (for these disks of mix file placement), if it's the single file type of disk, it will enter the first directory and play the first track in this directory automatically (the cursor is stopped on the position of "01: ").

The screen will display as follows:



D. Feature

- Easy to install and it will not damage the car and the user might install it by himself;
- No additional player is needed for the integration of display and player;
- Built in FM transmitter for wireless reception of audio through the FM tuner of factory radio
- Input jacks are provided to connect gaming system, GPS system, or other mobile audio/video players
- Audio and Video output jacks provided so that an additional monitors can be connected
- Unit can play video and audio files from USB drives and SD cards

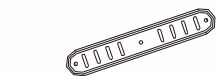
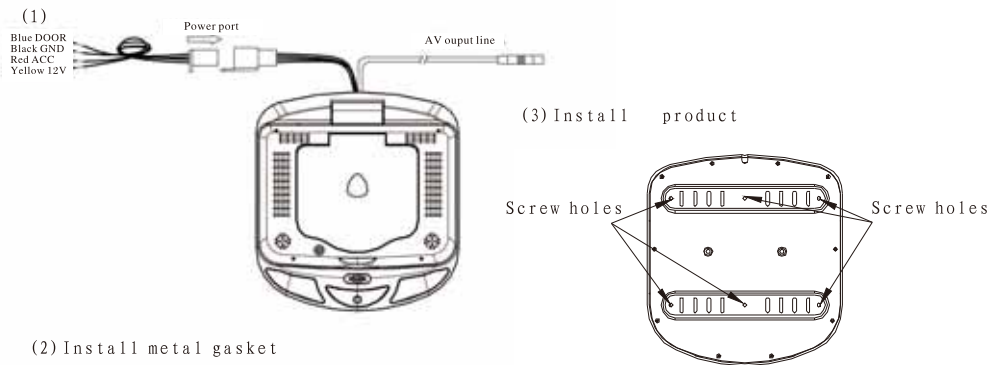
E. Video disk type

TYPE	RECORD FORMAT	HORIZONTAL DEFINITION	RECORD CONTENT	DISK SIZE
DVD	MPEG2	> 500 LINES	Audio+Video	12cm/8cm
VCD	MPEG1	> 240 LINES	Audio+Video	12cm/8cm
CD	Digital	—	Audio	12cm/8cm
Mp3	Digital	—	Audio	12cm/8cm
Mp4	MPEG4	>240 LINES	Audio+Video	12cm/8cm
WMA	Digital	—	Audio	12cm/8cm
JPEG	—	>500 LINES	Picture	12cm/8cm

F. System connection and installation

Check whether the shape and installation size is suitable, please select and employ suitable accessories and tool in disassembling and assembling.

The install method



Remove the metal bracket (2 pieces) and screws (6 pieces) and attach the metal brackets to vehicle

After attaching the metal brackets to vehicle, align the corresponding holes in unit and attach with screws

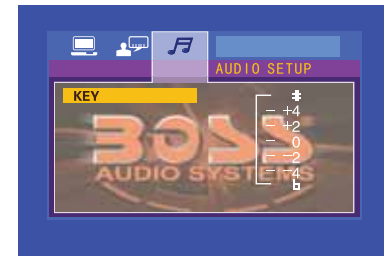
Note: the shape and installation size are not suitable for all cars, please select the suitable shape and installation size.

Audio Setup

Tone (see figure 9)

- Press setup Button and the screen will display the system setup image, select audio setup option and then select tone option, press enter Button to confirm and the screen shall display the image as figure 9.
- If the user wants to adjust the tone, press Direction Button to adjust and then press enter Button to confirm, press setup Button to exit the system setup.

Figure 9

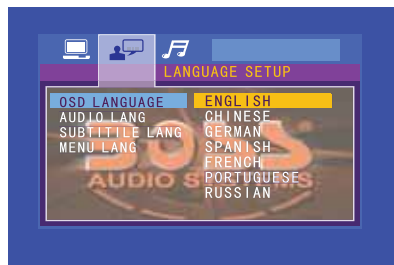


Language Setup

1. Image display language (see figure 7)

Press setup Button and the screen will display the system setup picture, select language setup and then select image display language option, select English, Chinese, German, Spanish, French, Portuguese, Russian. Press enter Button to confirm, the screen shall display the image as figure 7

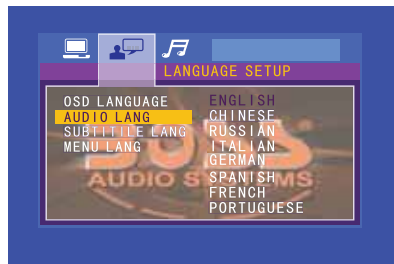
Figure 7



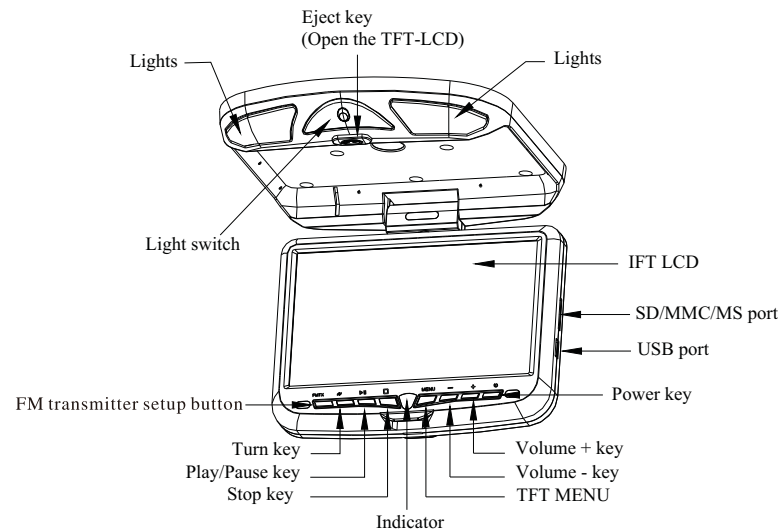
2. Audio language, subtitle language and menu language(see figure 8)

Select your desired audio, subtitle or menu language option, the available languages include English, Chinese, Russian, Italian, German, Spanish, French, Portuguese. Press enter Button to confirm and then press setup Button to exit menu setup.

Figure 8



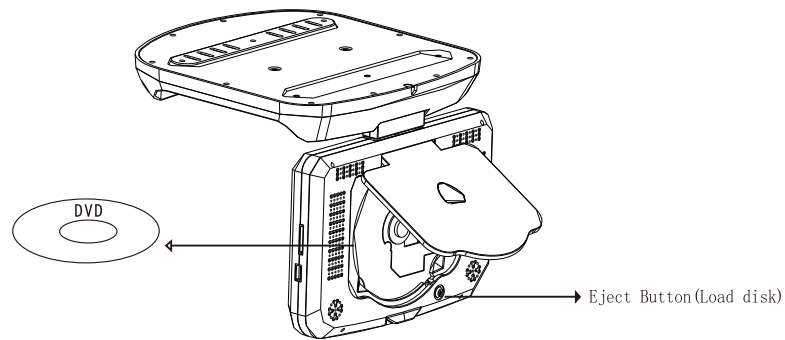
G. Button parts in front of the player



the note 1: The TFT MENU Button is used to adjust the color, contrast, and other settings for the display

the note 2: USB, and SD/MS/MMC card ports optional

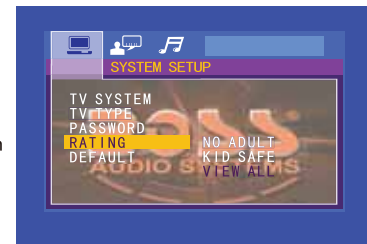
H. Button parts of the player



notice: Do not leave DVD door open other than to remove or insert the disc

- (2) Select your desired grade option after pressing grade Button to enter, and then press enter Button to confirm and exit the option(see figure 5).
- (3) Further select password option and then input the initial password(0000 or 8888, the effective password comprises of four numbers)(see figure 5)after pressing password option to enter, press enter Button to lock the function and then exit the option.

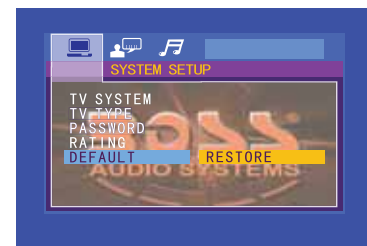
Figure 5



4. Default Value (see figure 6)

If the user doesn't want to save the setup set by himself for the functions, please select reset option and the DVD player shall reset to the ex-factory parameters.

Figure 6



2. Aspect Ratio(see figure 3)

- (1) 4: 3PS (panoramic scanning): applicable for general TV set, when playing wide screen image, the image shall be played on the whole screen and the left and right edges shall be cut off.
- (2) 4: 3LB (mailbox): for these TV sets with general sizes, please select this option. In playing wide screen image, the top and bottom of the screen shall have black frame.
- (3) 16: 9 (wide screen): when the player is connected to the wide screen TV set, please select this option. If the option is selected but it's not connected to the wide screen TV set, the image might be distorted for the vertical compression.

Caution:

- The aspect ratio is related to the disk recording format, so some disks might be not played in the aspect ratio you select;
- If 4: 3 disk is played on wide screen TV set, the left and right sides of the screen shall have black bars;
- Before playing, please select the suitable aspect ratio according to the actual TV set.

Figure 3

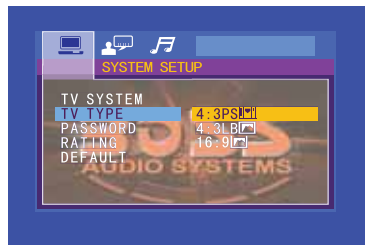
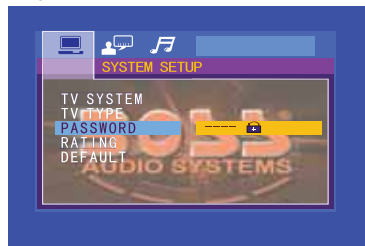


Figure 4



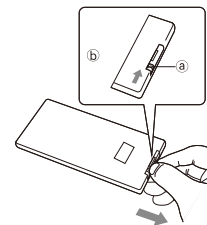
3. Password and Grade(see figure 4 and 5)

In playing these disks with lock function, the setup method for limiting the grade is described as follows:

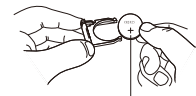
- (1) Input the initial password (0000, the effective password comprises of four numbers) (see figure 6) after pressing Password option to enter, press Enter key to unlock the function and then exit the option.

I. Battery installation of remote controller

- 1 Slide the lever "A" in the direction of the arrow to open battery door. Slide battery out as shown.

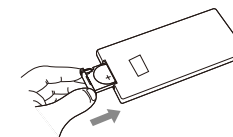


- 2 remove old battery and replace with new CR2025 with the "+" side facing upwards



Battery (Cr2025)

- 3 Place the battery holder back to its original position



Cautions:

In order to prevent the battery leakage, if the remote controller shall be not used for a long time (longer than one month), please take out the battery, if there is liquid flowing out, wipe away carefully and then reload the new battery.

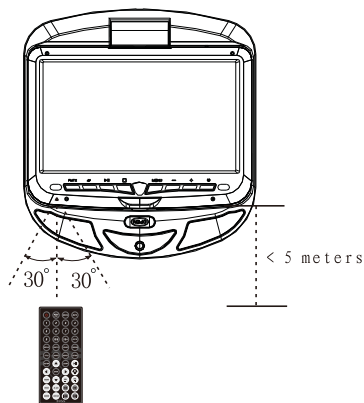
J. Precautions for remote controller

- Prior to the first use, remove the small clear plastic from bottom of remote to allow battery to make connection.
- Remote control operates by sending invisible light waves to main unit. Remote control needs line of sight to main unit to operate correctly.
- Remote control may not perform properly in direct sunlight

K. Application of remote controller

Application of remote controller:

1. Horizontal +/- 30 degrees
2. Vertical +/- 30 degrees
3. Straight line 5 meters (16 feet)



Note:
Most advanced functions are accessible from the remote control only. Only the basic functions can be controlled from the main unit.

0. Menu operation

Press Setup key and the LCD will display the picture as figure 1, press [◀] and [▶] key to move the white bar to the designated position, press Enter to confirm to display its submenu, or press [▶] key to enter its submenu directly.

Note: no matter in which state, press "▲"/"▼"/"◀" and "▶" key to move the white bar and press Enter key to make it available, press [◀] key to exit the submenu at the right of LCD and at any time press Setup key to exit the system.

Special Tips: for the company has many counterpart products, the figure is for reference only, all is subject the real product! The setup methods described in this instruction are for their common parts, other functions are recommended to use the default setup.

1. TV system (see figure 2)

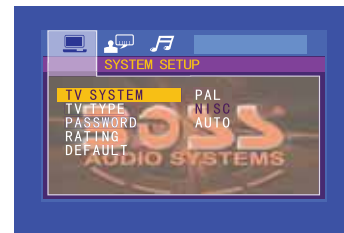
- (1) Press Setup key and the TV screen will display the system setup picture, select TV system and press Enter key to confirm, then the TV screen will display the picture as figure 2.
- (2) Enter the submenu at the right of screen. If you want to set the system to be PAL, first move the white bar on PAL column and then press Enter key to confirm, press Setup key to exit the system setup.

Note: the system of TV set should be same with the system of DVD player.

Figure 1

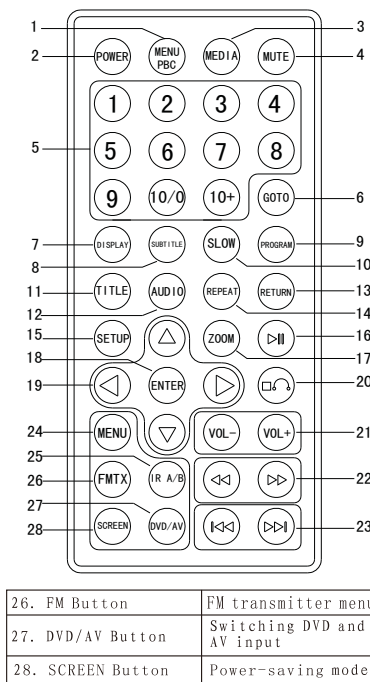


Figure 2



KEY	Basic description
1~10/0	Press any number key to select the track or chapter to be played and set up the playing time. The player features number key direct-selection function, press the your desired number to select. For example: select the 386 th track, first press number "3", and then press number "8", finally press number "6", the player shall play the 386 th track. Note: number key direct-selection function is available for Mp3, Mp4 and DVD disks only.
10+	For the track number bigger than 10, press the key first, the LCD will display 10+ and then press other number key to select, press the key in turn to achieve multiple modes
IR A/B	This Button is the selecting Button of IR channel. Press the Button successively to change the IR headphone channel, channel A or B.
MENU	This key is the selecting key of TFT LCD function. Press the key successively to switch the functions of brightness, contrast, color, definition and hue, and then press "-" and "+" key to adjust. After adjusting the parameters, press MENU key to return and the set parameters shall be saved.
DVD/AV	Video/AV switching key. Press the key, the player shall switch DVD state into AV-IN state, the video signal inputted by the video terminal shall be displayed on the TV screen. If there is no signal inputted, it shall be blue screen. Further press DVD/AV key to switch AV-IN state into DVD state.
FMTX	FM key, press the key to close the audio of the player and open the FM function. The LCD will display the corresponding frequency (the player provides multiple frequency points for selection). Press the key repeatedly to switch among the frequency points. If you don't want the FM function, please switch it to OFF state, at the time, the LCD will display FM OFF, and the DVD loudspeaker shall output audio signal. Note: in FM state, there is no sound output for loudspeaker.

L. Description for the pressing-Buttons of remote controller



Button	Function
1. Root menu/PBC	Press the Button to return to the root menu in playing DVD disk, and open/close the PBC menu in playing VCD2.0 and SVCD.
2. Power	Power ON/OFF
3. Media	Function: You can switch between USB/SD/DISK
4. Mute	Mute / un-mute the sound
5. Number Button	Number selection
6. GOTO	Select desired time to play
7. Display	Display the disk information and playing time
8. Subtitle	Subtitle switching, used for SVCD, DVD and Mp4 disks with multiple subtitles only
9. Program	Track programming play
10. Slow	Slow play
11. Title menu	Press the Button to return to the title menu in playing DVD disk.
12. Channel/ Language	Channel and language switching Buttons
13. Return	Back to the root directory
14. Repeat	Multiple modes of repeat play shall be available
15. Setup	Open/close DVD setup menu
16. Play/Pause	Play or pause
17. Zoom	Zoom in/out, multiple modes
18. Enter	Confirmation
19. Direction Button	Direction selecting Button
20. Stop/Return	Stop Button, press the Button to return in playing
21. Vol+/-	Adjust the volume
22. Fast forward/backwardPlay	Fast forward or backward
23. Previous/Next	Select the previous or next track
24. Menu	Switching the menu of LCD brightness, contrast, definition, color and tint.
25. IR A/B Button	IR channel Button

M. Basic operations

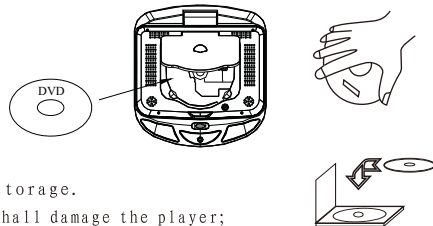
The player may be used after being connected to the system.

1. Power ON/OFF

- (1) Press the panel or the Power Button at the top left angle of the remote controller, the power indicator shall be turned off and the boot image shall be displayed, the player will read the disk, if no disk inside, the LCD shall tell No Disk.
- (2) In Power ON state, further press Power Button to power off the player and the indicator shall be turned on.

2. Load disk

- (1) Press Eject Button to open the disk door;
- (2) Load the disk (with the label side upwards).
- (3) Close the disk door.
- (4) The player shall play the disk automatically.



3. Remove disk




- (1) Press Stop Button to stop playing;
- (2) Press Eject Button to eject the door;
- (3) Take out the disk;
- (4) Put the disk back to the package bag or box for storage.

- Caution:**
- Be careful to take the disk, wrong operation shall damage the player;
 - Do not damage the disk, or the player shall be damaged;
 - Please keep the side with label upward if it's a single-side disk;
 - Be careful in playing two-side DVD disk for the two sides of the disk are available for playing;
 - Do not scratch the surface in taking the disk.

4. USB and card reading

- (1) The external USB memorizer (USB disk) might be connected by the attached USB connection line. In the state of Power OFF and no disk is loaded inside, connect the external memorizer to the corresponding USB port, and then press Power Button to power on the player, the device shall detect the signal source automatically (including video, audio and image), and the player shall play automatically if the signal source format that complies with the player, is detected.
- (2) In the state of Power OFF and no disk is loaded inside, connect the external memorizing card (MS/SD/MMC card) to the corresponding port, and then press Power Button to power on the player, the device shall detect the signal source automatically (including video, audio and image), and the player shall play in order automatically if the signal source format that complies with the player, is detected.
- (3) The contents of Mp3, WMA, Mp4 and JPEG formats could be downloaded from the internet through PC and be saved in the USB disk or external memorizing card to play.

- Caution:**
- Do not pull off the external memorizer when the player is connected with power, otherwise the external memorizer or the player shall be damaged;
 - All signal sources that comply with the player might be played through the external memorizer;
 - Individual MP3 player couldn't play through USB device.

Button	Basic description
Vol+ Vol-	Volume adjustment Button Adjust the volume by the Vol+ and Vol- Button on the remote controller
Setup	Press the Button to enter the setup menu to set up system, language, audio, video, loudspeaker and dolby digit, in setup menu, press the Button to exit the menu interface.
 Direction Button	Up/Down/Left/Right Button Press the Buttons to select the disk content to be played and item to be set up as well as to select the image part to be zoomed.
MEDIA	Function: You can switch between USB/SD/DISC 
Channel/ Language	<p>1. DVD disk supports eight languages at most, repeatedly press Language Button to select the different language to play. If the disk hasn't the language menu, the user may also change the language by menu.</p> <p>Note: language function is only used for these DVD and super VCD disks that have multiple languages for selection.</p> <p>2. In playing VCD or individual MP4 disk, press Channel Button to change the channel mode: Changing the channel mode might eliminate the original singer's sound of OK disk and convert the dialogue language of some disks.</p> <p style="text-align: center;">Stereo → Left Channel → Right Channel </p> <p>Note: Channel function is not available for MP3, CD, WMA, JPG and individual MP4 disk.</p>

Button	Basic description
Zoom	<p>Press Zoom Button to zoom in the image. In playing, press Zoom Button, the zoom mode shall be cycled as per the following order: ZOOM 2 → ZOOM 3 → ZOOM4 → ZOOM 1/2 → ZOOM 1/3 → ZOOM 1/4 → ZOOM: OFF</p> <p>In Image Zoom state, press direction Button " " to move the image.</p>
GOTO	<p>GOTO: start to play from the selected time. Press GOTO Button on the remote controller then a time selection dialog box shall be skipped out, move the cursor to the time number and input the time you want to select and then the player shall start to play from the selected time.</p> <div style="border: 1px solid black; padding: 5px; width: fit-content; margin: 10px auto;"> TITLE 1/1 CHAPTER 1/29 00 : 00 : 12 </div> <p>Note: the setup of VCD disk is same with DVD disk, the input time couldn't exceed the longest time of the disk.</p>
SCREEN	Power-saving mode
Subtitle	<p>Open/close the subtitle, select the subtitle on DVD disk and it's displayed on the TV screen, which is related to the format of disk. Subtitle is available only in the condition of the disk having subtitle function, the subtitle function is achieved by the Subtitle Button on the remote controller, press the Button successively to select different subtitles.</p>
Title	Press Title Button to stop playing and return to the title menu of disk, press direction Button to select your desired title and press Enter Button to confirm to enter the chapter menu.

N. Functions of Buttons

Button	Basic description
Power Button	Turn the unit on/off
Eject Button	Open the disk door.
Play/Pause	In normal playing state, press the Button to pause to play image/sound. Further press the Button to resume to play normally.
Fast backward Fast forward	<p>Press Fast backward Button, the image shall be played backward quickly, at the time, no sound shall be outputted, press the Button successively, the player shall play the disk repeatedly as per the following method; Press Fast forward Button, the image shall be played forward quickly, at the time, no sound shall be outputted, press the Button successively, the player shall play the disk repeatedly as per the following method;</p> <p style="text-align: center;">Fast forward (backward) → X2 → X4 → X8 → X20</p>
Previous Next	<p>Press the Previous Button to select the previous track to play. Press the Next Button to select the next track to play.</p>
Stop	<p>In playing VCD and CD disk, press " " (Stop/Return) Button to display pre-stop state, at the time, press Play Button to resume to play; further press Stop Button to stop playing and return to the boot interface state. In playing DVD or VCD2.0 disk, it plays the role of returning menu, and of stopping playing in playing menu. In playing game, press the Button to return to the main menu of game. Note: MP4 and DVD doesn't have the function of pre-stop.</p>

Button	Basic description
Slow	<p>Play by the lower speed, press the Button successively to make the player play repeatedly, press "⏮" (Play/Pause) Button to resume to play normally. In playing DVD disk:</p> <p style="text-align: center;"> </p>
Program	<p>Setup of programming play: arrange the playing order of disk and then the player shall play the disks as per the arranged order. Note: the program Button shall not be available unless PBC is closed, program is not allowed for MP3 disks; DVD disk should be programmed for its track time and VCD disks should be programmed for its track number. Finally, select Play Button and the player shall play the disks automatically as per the arranged order, at the time, the number Buttons are not available, only the previous/next Button could be used. If you want to cancel the programming function, press Program Button to enter the menu interface and select Clear Button and then press Enter Button to confirm.</p>
Repeat	<p>Repeat play Repeatedly play the selected title/chapter (DVD) or track/album (VCD/CD disk). In playing DVD disk, press the Button successively to select the title or chapter of DVD to play. For other types of disks, press Repeat Button successively to select one track or the album to play repeatedly.</p>
MENU PBC	<p>In playing VCD2.0 or SVCD disk, the PBC menu function could be achieved by press PBC Button, the disks could only be played in order if PBC is closed. In playing DVD disk, press the Button to stop playing and return to the root menu of disk, press direction Button or number Button to select your desired contents and press Enter Button to confirm, the player shall start to play as per the title or contents you set up. Note: PBC is not available in playing Mp3, CD or VCD 1.1 disks.</p>

Button	Basic description
Display	<p>Press Display Button for the first time, the LCD shall display: (DVD state) 1) Disk format, current title number and total title number; 2) The Current chapter and total title number; 3) The playing of current title.</p> <p style="text-align: center;"> </p> <p>Further press the Button to display: Display the current language and the language number supported, channel type, subtitle display language and angle type.</p> <p style="text-align: center;"> </p> <p>Press the Button for the third time to display nothing. The display (OSD) in playing VCD disk is as follows:</p> <p style="text-align: center;"> </p> <p>Display the disk format, current track and total track number, mute mode, PBC mode, and the track number of repeat mode, and the track playing time. The OSD of MP3 and CD disk is same with VCD except that VCD disk has PBC option.</p>
Mute	<p>Firstly press the Mute Button, the player shall play the image without sound output, further press the Button to cancel the mute function and resume to play normally.</p>