

PLEASE CONTACT US FIRST

TollFree: 1-800-935-3959 (Mon. Fri. 9:00AM to 5:00 PM EST)

✉ support@teamson.com

☎ 1-631-274-3353

Thank you for choosing Teamson produce. If you need help with assembly or if you are missing parts, hardware, we are here to help !



Versanora

Item No: VNF-00081

Item name: Versanora - Ashton Sideboard
- FauxMarble/Walnut

Warning

Small parts and sharp points may be present prior to assembly. Please follow the assembly instructions closely. Improper assembly can result in personal or property damage. 2 adults are required to safely assemble this product.







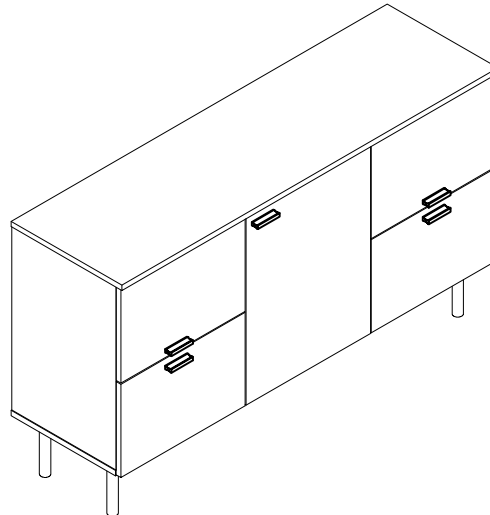



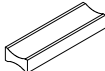





Care Instructions

Dust often using a clean, soft, dry and lint-free cloth. • When blot spills, wipe with a clean, damp cloth immediately. We do not recommend the use of chemical cleansers, abrasives or furniture polish on our lacquered finish.

Periodically check to make sure all connections are tight. Re-tighten if necessary.





Hardware List:

A	B	C	D	E	F	G	H
							
5PCS	10PCS	2PCS	12PCS	16PCS	9PCS	24PCS	24PCS
I	J	K	L	M	N	O	P
							
18PCS	8PCS	8PCS	22PCS	4PCS	8PCS	8PCS	1PCS

MADE IN CHINA

www.teamson.com

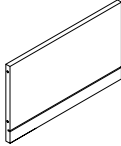
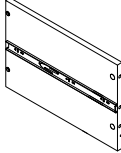
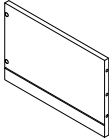
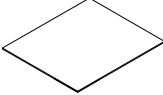
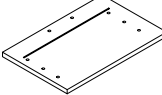
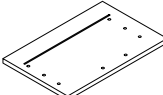
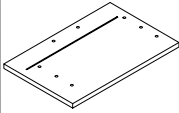
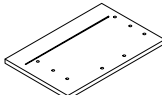
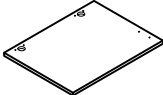
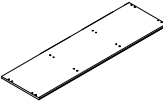

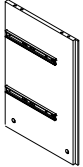
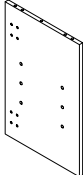
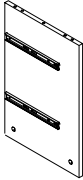
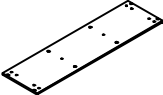
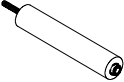
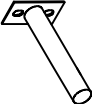
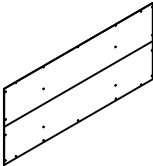
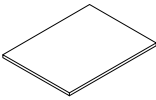



Part List:

1	2	3	4	5	6
					
4PCS	4PCS	4PCS	4PCS	1PC	1PC
7	8	9	10	11	12
					
1PC	1PC	1PC	1PC	1PC	1PC
13	14	15	16	17	18
					
1PC	1PC	1PC	2PCS	4PCS	1PC
19					
					
1PC					

MADE IN CHINA

www.teamson.com

STEP 1

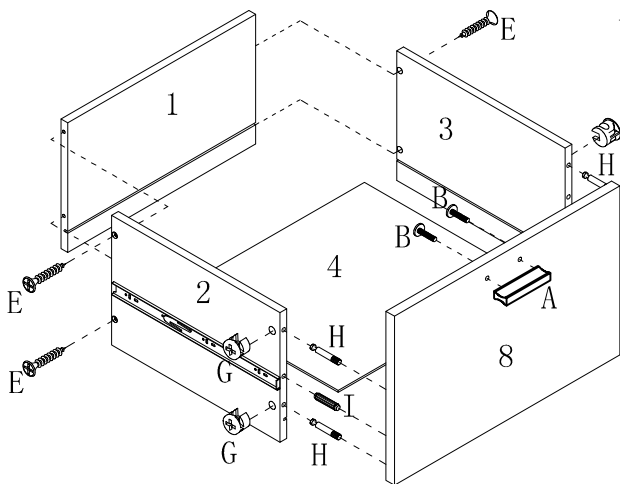
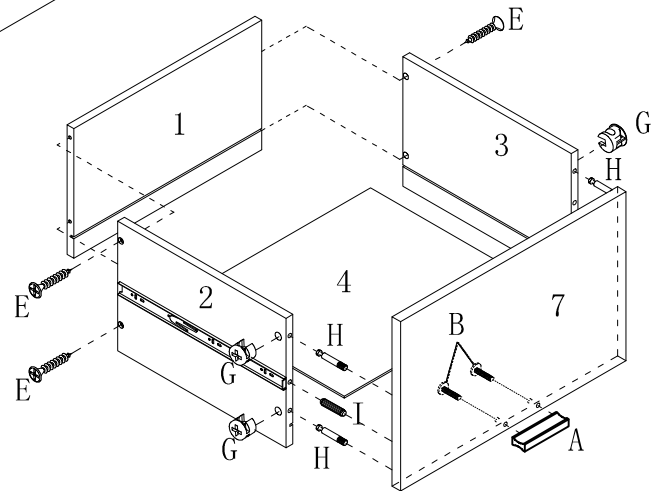
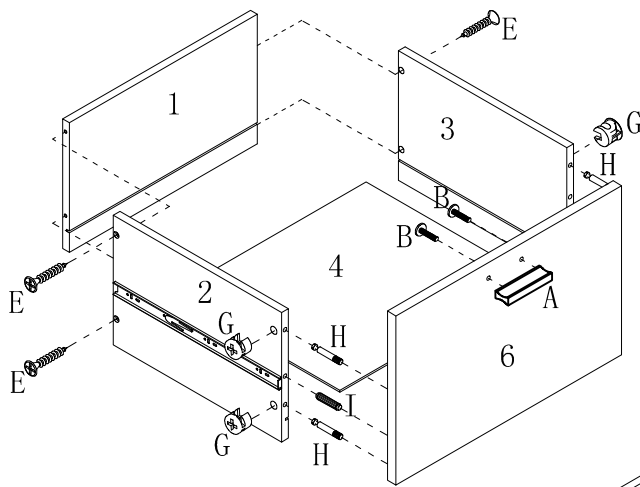
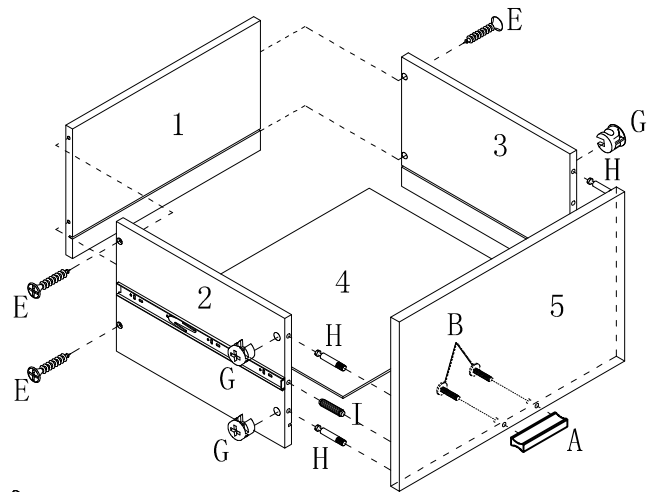

A:		4 PCS
B:		8 PCS
E:		16 PCS
G:		16 PCS
H:		16 PCS
I:		8 PCS



MADE IN CHINA



www.teamson.com

STEP 2

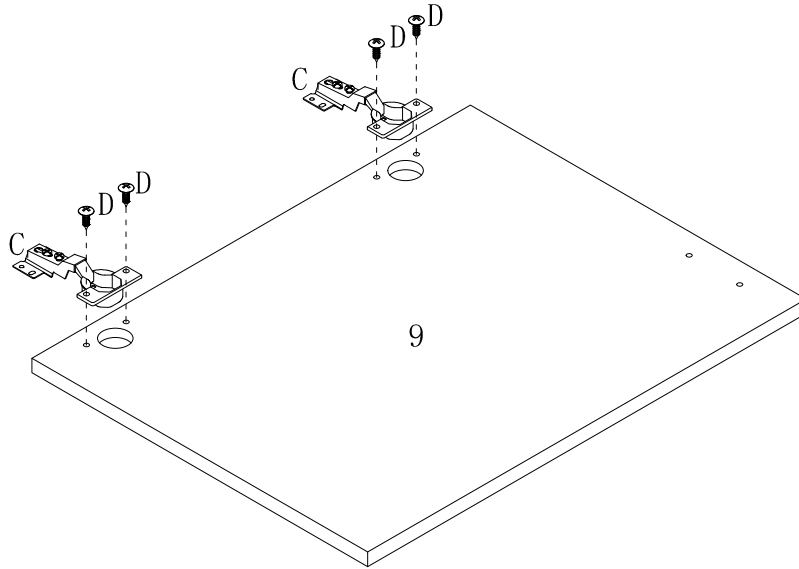
C:		2 PCS
D:		4 PCS



STEP 3

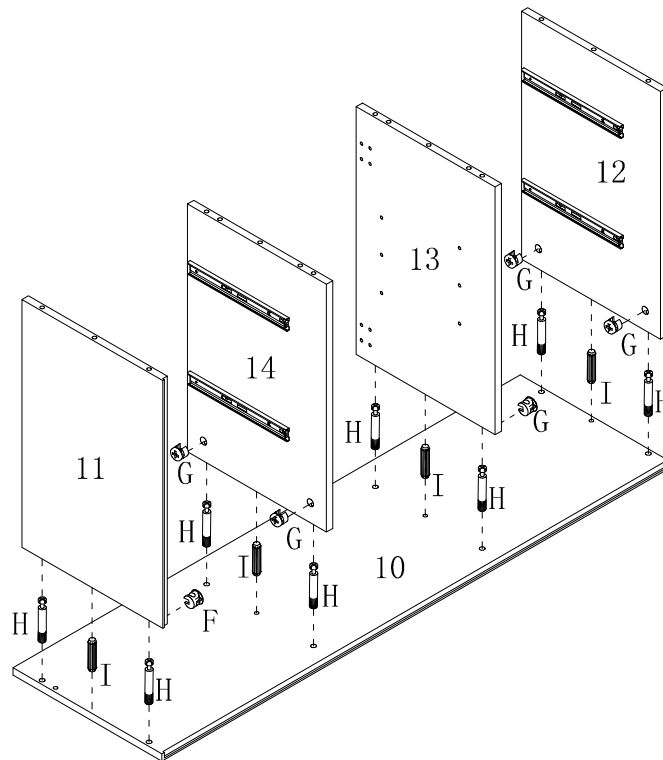

G:		8 PCS
H:		8 PCS
I:		4 PCS



MADE IN CHINA



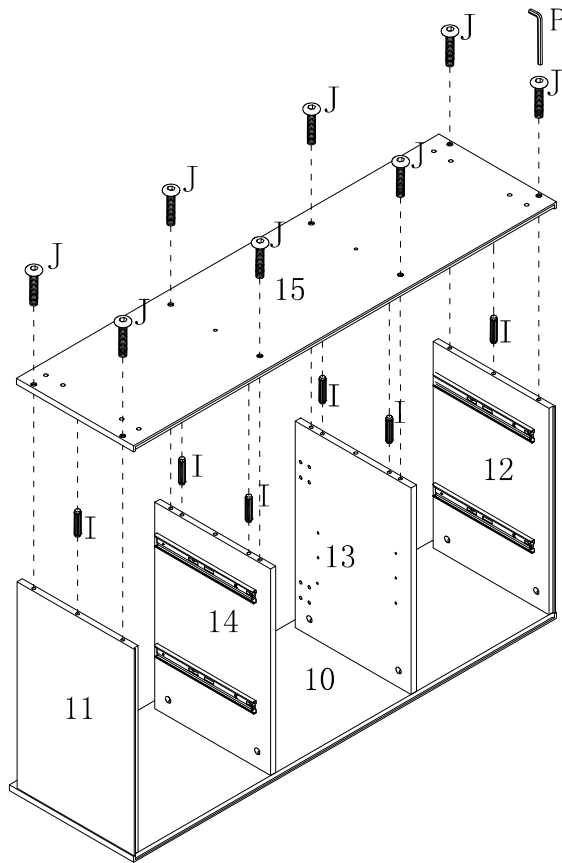

www.teamson.com

STEP 4

I:		6 PCS
J:		8 PCS
P:		1 PCS



STEP 5

K:		8 PCS
N:		8 PCS
O:		8 PCS
P:		1 PCS

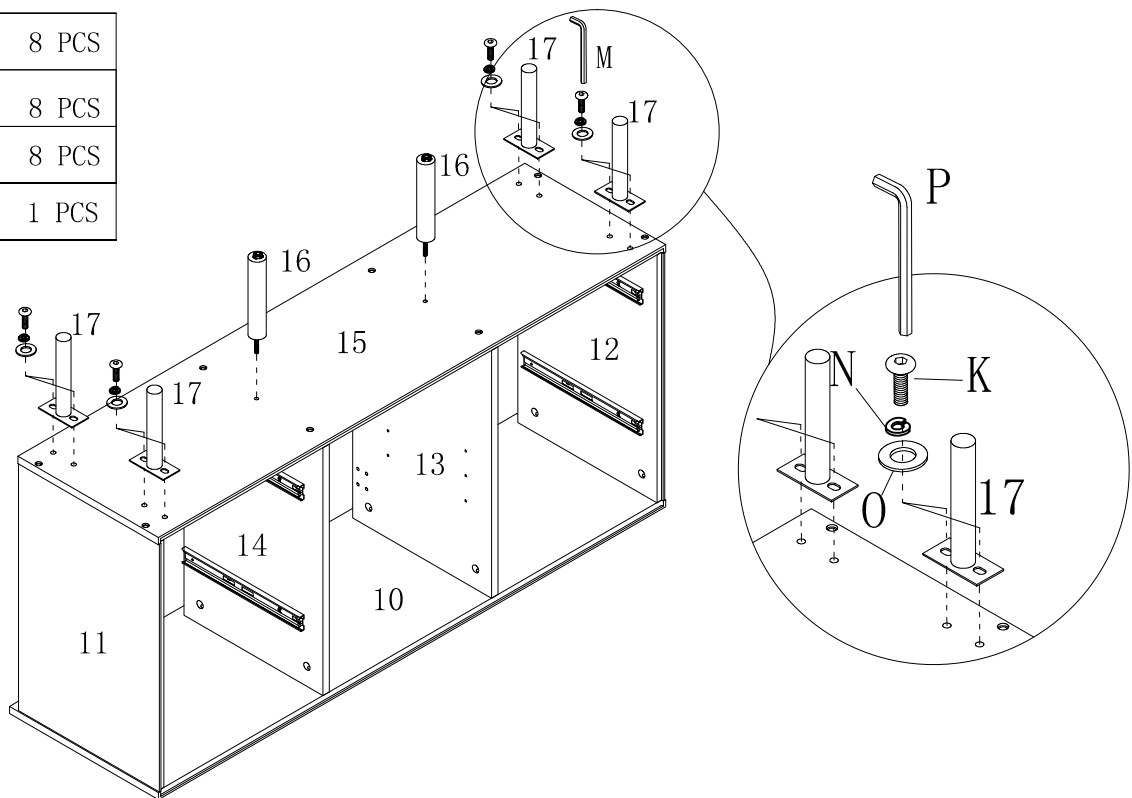

MADE IN CHINA

www.teamson.com

STEP 6

L:  22 PCS

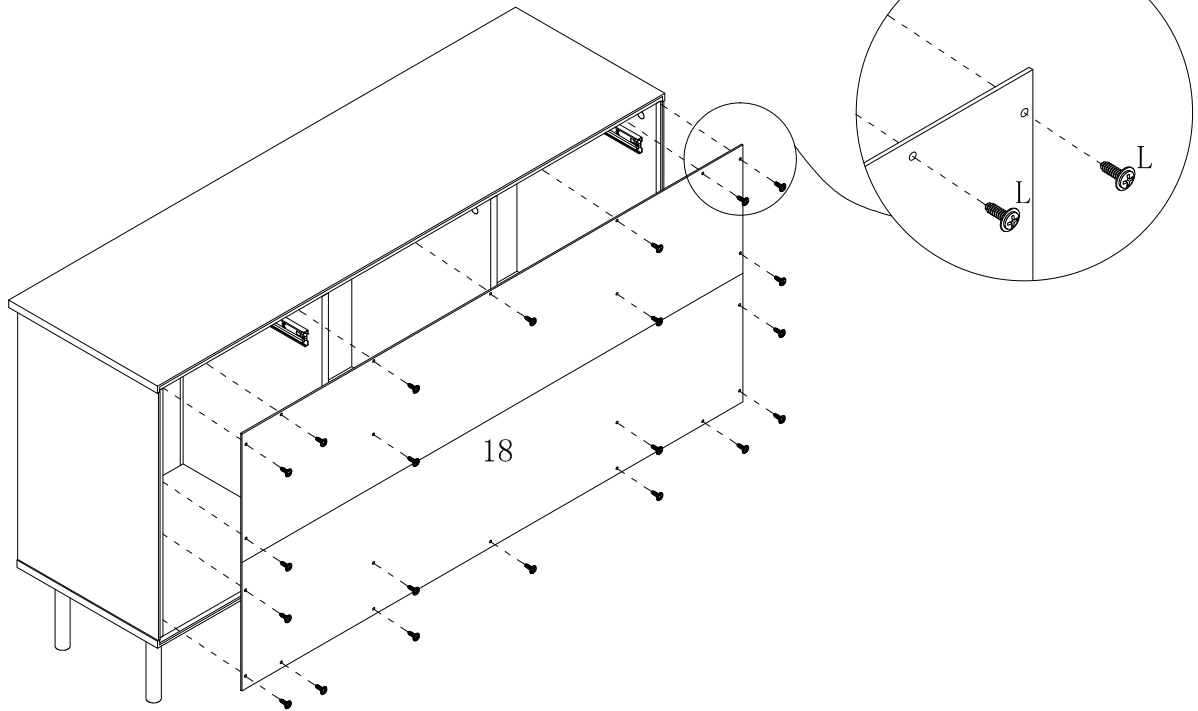

STEP 7

F:  8 PCS

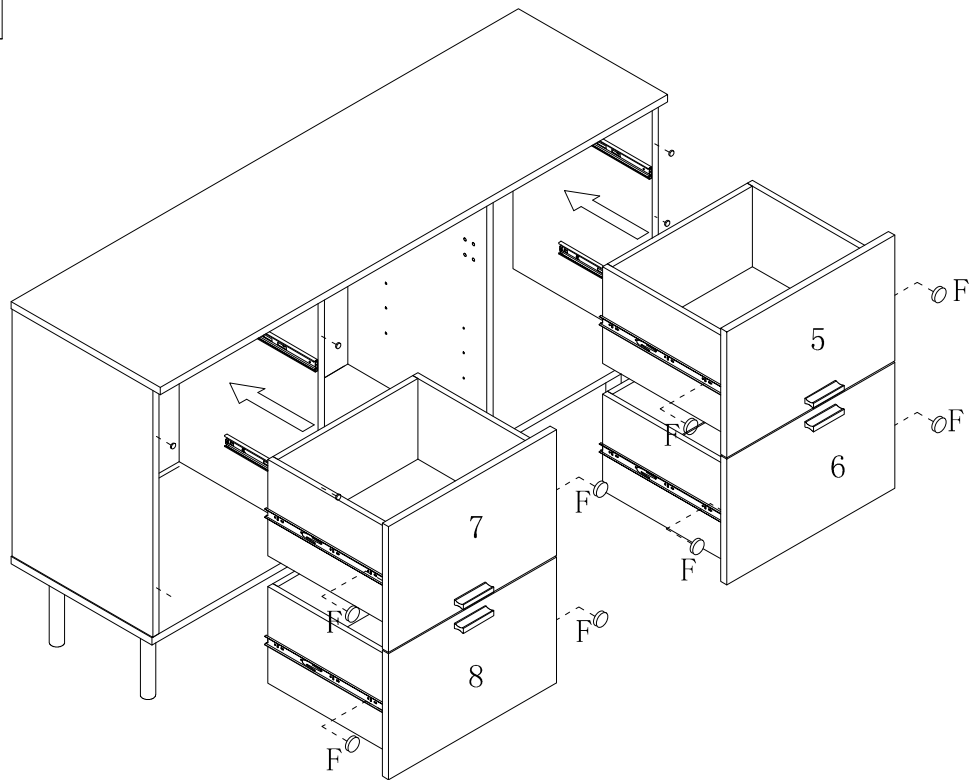





MADE IN CHINA

www.teamson.com

STEP 8

Anti -Tip hardware assemble

A:		1 PCS
B:		2 PCS
D:		8 PCS
N:		4 PCS
F:		1 PCS

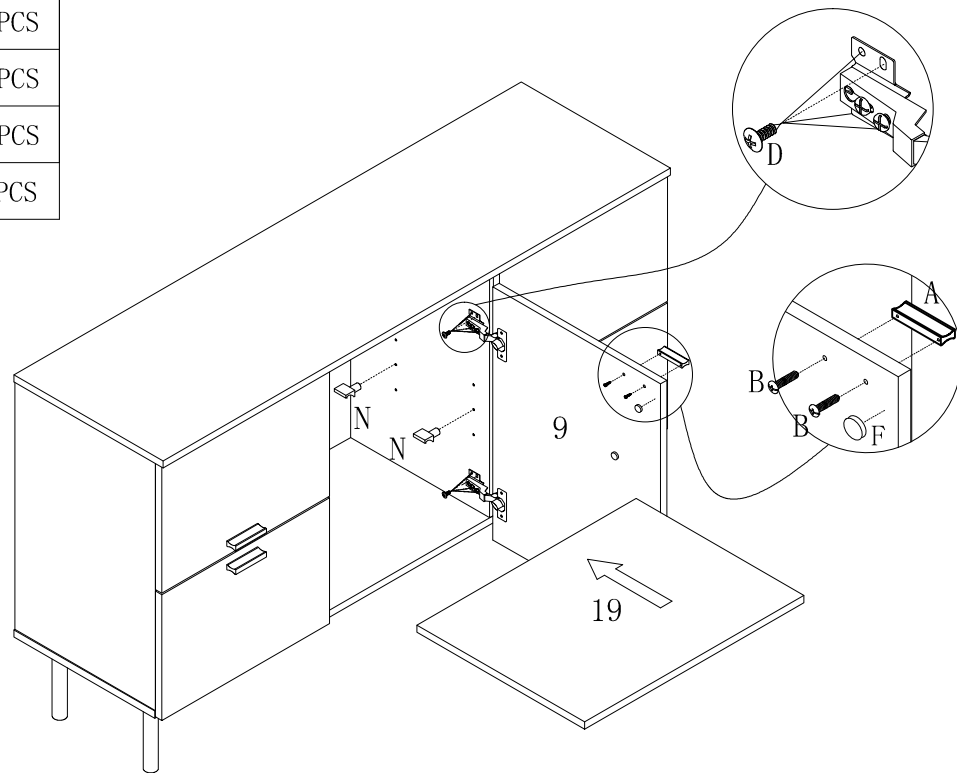

STEP 9

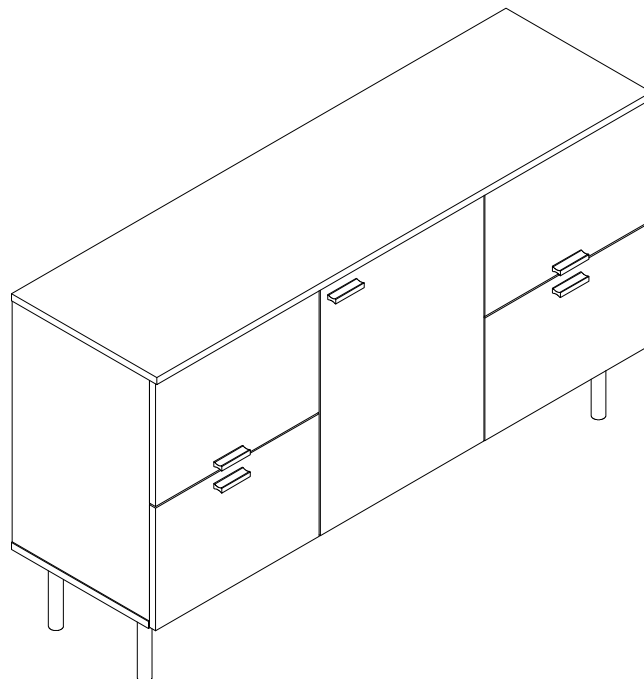

MADE IN CHINA

www.teamson.com