



BESTAR
Reinvent your space™



<http://bestar.ca>
<http://bestar.com>

MODEL • MODÈLE • MODELO
52414-1
COLOR • COULEUR • COLOR
WO

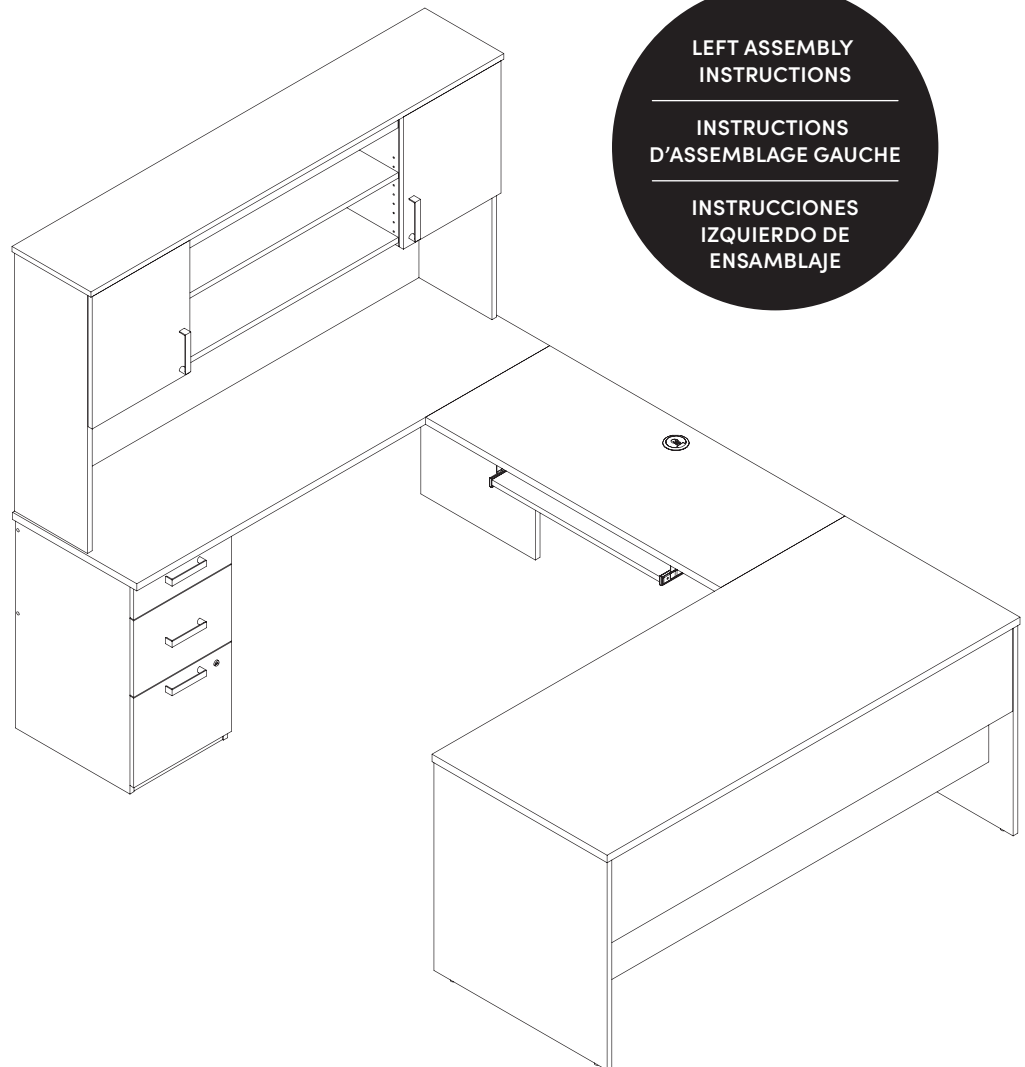

LEFT ASSEMBLY
INSTRUCTIONS

INSTRUCTIONS
D'ASSEMBLAGE GAUCHE

INSTRUCCIONES
IZQUIERDO DE
ENSAMBLAJE



Video assembly guides
Guides d'assemblage en vidéo
Instrucciones de ensamblaje de vídeo
www.bestar.com/video-assembly-guides

SERVICE • SERVICIO
1-888 8BESTAR (1-888 823-7827)



Should you need more information concerning the warranty, do not call to the place of purchase. Please call our customer service department for immediate assistance using the toll free number below. Please have your assembly instruction manual on hand when you call.

BESTAR products are warranted to the original purchaser against defects in material or workmanship in the furniture. Defects as mentioned in this warranty refer to any imperfections which may impair the use of the product. Our warranty is expressly limited to the replacement of furniture parts and components for the time specified in the product description and following the date of purchase. BESTAR will replace any part that is defective. This warranty applies under conditions of normal use. Our furniture products are not intended for outdoor use, except those in the Outdoor Collection. The warranty does not cover labor or assembly costs or defects caused by improper assembly or disassembly, after-purchase product modifications, intentional damage, accidents, or exposure to the elements. Bestar reserves the right to request a proof of purchase to document a warranty claim. In no event shall BESTAR be liable for incidental or consequent damages resulting from the misuse of the product. This warranty is not transferable and is valid only in Canada and the United States excluding Alaska, Hawaii and Puerto Rico.

Si vous souhaitez de plus amples informations concernant votre garantie, ne vous adressez pas au magasin où vous avez effectué votre achat. Pour obtenir une aide immédiate, veuillez appeler notre service client au numéro sans frais ci-dessus. Veuillez avoir en main le manuel d'instructions lors de votre appel.

La garantie des produits BESTAR est valide pour l'acheteur initial en cas de défaut de matériaux ou de fabrication. Les défauts couverts par cette garantie incluent toutes les imperfections qui peuvent nuire à l'utilisation normale du produit. Notre garantie est expressément limitée au remplacement des composants et des éléments de meubles pour une durée spécifiée sur la fiche produit et suivant la date de l'achat. BESTAR s'engage à remplacer tout élément défectueux. Cette garantie s'inscrit dans le cadre d'une utilisation du produit dans des conditions normales. Nos meubles ne sont pas destinés à être utilisés à l'extérieur, sauf ceux de la collection Outdoor. La garantie ne couvre pas les coûts de main-d'œuvre ou d'assemblage ni les défauts causés par un assemblage ou un démontage non conforme, par des modifications apportées au produit, par des dommages intentionnels, par un accident ou par l'exposition des meubles aux intempéries. Bestar se réserve le droit d'exiger une preuve d'achat afin de documenter la réclamation. La société BESTAR ne pourra être tenue, en aucun cas, responsable de dommages indirects ou consécutifs suite à une mauvaise utilisation du produit. Cette garantie ne peut être transférée et est valide au Canada et aux États-Unis sauf à Hawaï, à Puerto Rico et en Alaska.

Si necesita más información sobre la garantía, no vaya al lugar donde realizó la compra. Llame a nuestro departamento de atención al cliente para recibir ayuda inmediata utilizando nuestro servicio de llamada gratuita. Cuando llame, tenga a mano su manual de instrucciones de montaje.

Los productos BESTAR están garantizados por el comprador original contra defectos en el material o en la confección del mueble. Los defectos, tal como se describen en esta garantía incluyen toda imperfección que pueda impedir el uso normal del producto. Nuestra garantía se limita expresamente al reemplazo de las partes y componentes del mueble defectuosos por diez años a partir de la fecha de compra. BESTAR reemplazará cualquier pieza defectuosa. Esta garantía se aplica según las condiciones de uso normal. Nuestros productos no están diseñados para ser utilizados al aire libre. La garantía no cubre defectos causados por ensamblaje o desensamblaje incorrectos, defectos ocurridos luego de la compra por la modificación del mueble, daños intencionales, accidentes, exposición a los agentes naturales ni costos derivados de la fabricación o ensamblaje. Bestar se reserva el derecho de solicitar una factura de compra para poder extender un reclamo de garantía. Bajo ninguna circunstancia BESTAR será responsable de los daños accidentales o consecuentes que pudieran resultar del uso incorrecto del producto. Esta garantía es intransferible y se aplica solamente a Canadá y los Estados Unidos.



If there are parts missing from your order or if your product was damaged during shipping,
PLEASE CONTACT US DIRECTLY.

S'il vous manque des pièces ou si votre meuble a été endommagé pendant le transport,
VEUILLEZ NOUS CONTACTER DIRECTEMENT.

*En caso de piezas faltantes o si su producto fue dañado durante el envío,
POR FAVOR CONTÁCTENOS DIRECTAMENTE.*

Need help? • Questions? • ¿Cuestión?

**If you have any questions or concerns,
please visit our website:**

Si vous avez des questions ou des préoccupations,
veuillez visiter notre site web à l'adresse :

Si tiene dudas o inquietudes, visite nuestro sitio web:



www.bestar.com/support

or call our toll-free number:

ou appeler sans frais au :
o llame sin costo a:

1-888 823-7827



Make a phone appointment
Prenez un rendez-vous téléphonique
Agendar una cita telefónica

www.bestar.com/online-appointment



Send us an email
Envoyez-nous un courriel
Envíenos un correo electrónico

www.bestar.ca/contact-us



Need help?
Besoin d'aide?
¿Necesita ayuda?

www.bestar.com/faq

**Activate your warranty now:**

Activez votre garantie dès maintenant :

Active su garantía:www.bestar.com/activate-my-warranty**Information required to make a warranty claim**

Éléments nécessaires pour présenter une réclamation

Información necesaria para hacer válida la garantía**A copy of your receipt.**

Copie de votre reçu.

Una copia de su recibo de compra.**Pictures of the damaged parts.**

Photos des pièces endommagées.

Fotos de las partes dañadas.**You must know the name of the product, the item number and the name of the store where the item was purchased.**

Repérez votre produit sur Bestar.com. Vous devez connaître le nom du produit, le numéro d'article et le nom du magasin où vous l'avez acheté.

Debe conocer el nombre y el número del producto y, el comercio donde realizó la compra.**Please collect this information BEFORE contacting our customer service.**

Veuillez recueillir tous ces renseignements AVANT de communiquer avec le service client.

Por favor, tenga toda esta información a la mano ANTES de contactar al departamento de servicio al cliente.



**Never leave damp clothes, liquids or damp cloths on the furniture.
If a liquid has spilled on the furniture, clean the liquid up immediately.**

Ne laissez jamais de liquide ni de vêtements ou de linge humides sur le meuble.

Si un liquide est renversé sur le meuble, épongez-le immédiatement.

Nunca deje líquidos o un trapos húmedos sobre su mueble.

Si se derrama un líquido sobre la superficie del mueble, límpielo inmediatamente.



**Clean the furniture with a damp cloth, then wipe dry.
To avoid damaging the finish, do not use cleaning products on the furniture.**

Nettoyez votre meuble avec un linge légèrement humide, puis essuyez-le ensuite.

N'utilisez pas de produits de nettoyage, car cela risque d'endommager le fini.

Nunca utilice limpiadores químicos, ya que estos dañarán el acabado.

Use solo un paño húmedo.



**Do not put devices with plastic or rubber pads directly on your furniture.
Instead, attach cloth or felt pads to your device.**

Évitez de déposer des appareils munis de patins en caoutchouc ou en plastique directement sur le meuble. Utilisez des protecteurs en tissu ou en feutre sous les appareils.

Evite apoyar aparatos con bases de plástico o de goma directamente sobre su mueble.

Utilize un protector de tela o de fieltro.



To avoid dulling the finish, do not place furniture in direct sunlight.

Afin de préserver la belle apparence de votre meuble,
évitez de l'exposer à la lumière directe du soleil.

Para prevenir empañamiento, no exponga el mueble directamente a la luz solar solar.



At Bestar, we take pride in manufacturing stylish and functional furniture for your home and workspace. We go beyond manufacturing furniture: we offer solutions to optimize and customize your home and workspace. That's why customer satisfaction is our number one priority!

Chez Bestar, nous sommes fiers de fabriquer des meubles modernes et fonctionnels pour rehausser votre espace de vie ou votre lieu de travail. Plus encore, nous nous engageons à vous offrir des solutions pour optimiser et personnaliser votre résidence et votre espace de travail. Voilà pourquoi votre entière satisfaction nous tient à cœur !

En Bestar nos enorgullecemos de crear muebles funcionales y con estilo para su hogar y oficina. Vamos más allá de la fabricación de muebles: ofrecemos soluciones para optimizar y personalizar su hogar u oficina. Por eso su satisfacción es nuestra prioridad número uno.

Satisfaction Survey

Sondage de satisfaction

Encuesta de satisfacción



Stay in touch with us

Restez en contact avec nous

Manténgase en contacto con nosotros

www.bestar.com/blog



Parts & Hardwares • Pièces et quincailleries • Piezas Y Quincallas





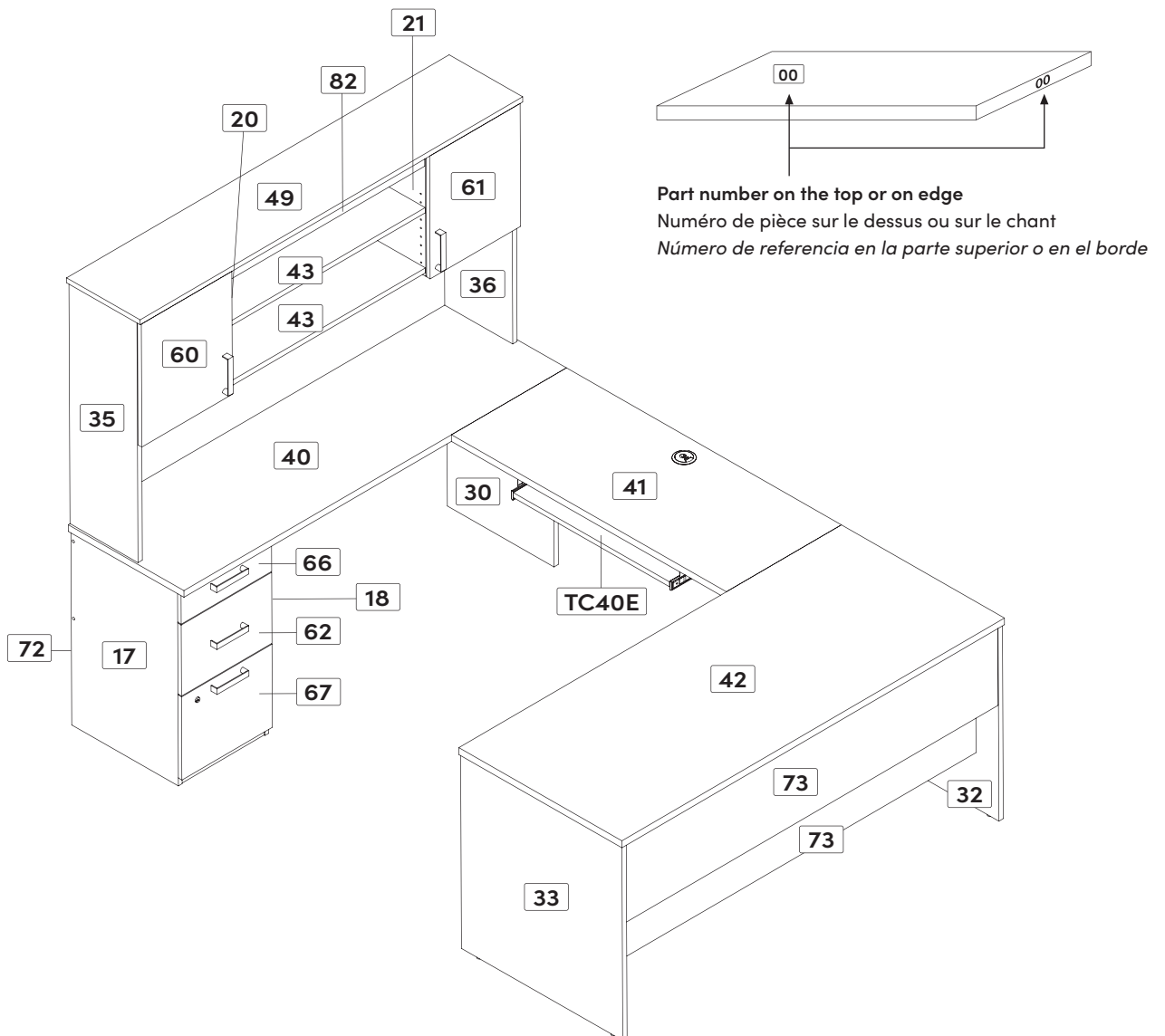











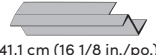

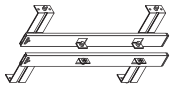

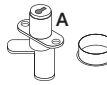

Parts • Pièces • Piezas

Code • Código	Qty • Qté • Cant.	Code • Código	Qty • Qté • Cant.	Code • Código	Qty • Qté • Cant.	Code • Código	Qty • Qté • Cant.
CA01A	2	33	1	49	1	75	1
CA05A	2	35	1	60	1	82	1
CA09A	2	36	1	61	1	CA15A bottom • fond • fondo 39,1 cm x 31,6 cm (15 3/8 x 12 1/2 in./po.)	2
CA13A	2	40	1	62	1	TC40E	1
17	1	41	1	66	1		
18	1	42	1	67	1		
20	1	43	2	70	1		
21	1	44	1	71	1		
30	1	45	1	72	1		
32	1	47	2	73	2		

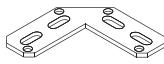

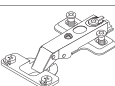

Parts & Hardwares • Pièces et quincailleries • Piezas Y Quincallas

Hardwares • Quincailleries • Quincallas

Code • Código	Qty • Qté • Cant.	Code • Código	Qty • Qté • Cant.	Code • Código	Qty • Qté • Cant.	Code • Código	Qty • Qté • Cant.
AM-182	 1/16 in/po (2 mm) 4	CL-745	 1	EX-743	 30,3 cm (11 7/8 in./po.) 2	PO-1028	 5
CA-77	 2	CO-249	 2		 41,1 cm (16 1/8 in./po.)	RU-420	 2
CA-99	 5/8 in/po (15 mm) 52	CO-843	 1	H-03	 56	SE-736	 1
CA-100	 3/32 in/po (2,5 mm) 2	EC-744	 4	H-36	 56		 Not used Non-utilisé No utilizado
CA-103	 4	EQ-143	 4	PA-844	 1 in/po (25 mm) 10	TI-118	 8
CH-838	 6	EQ-314	 3	PF-108/PF-785	 1	TI-552	 1

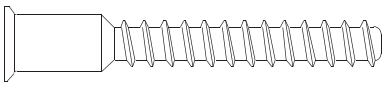
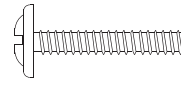
Real Size • Tailles réelles • Tamaño real

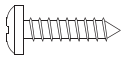
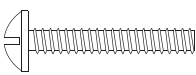
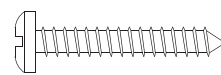
Code • Código	Qty • Qté • Cant.	Code • Código	Qty • Qté • Cant.
VC-204	 2 in/po (50 mm) 2	VM-601	 3/4 in/po (20 mm) 4
VE-244	 3/8 in/po (10 mm) 10	VR-207	 1/2 in/po (13 mm) 20
VF-232	 7/8 in/po (22 mm) 10	VR-212	 1 in/po (25 mm) 36

Important Notice • Note importante • Nota importante

Group together all the hardware required for each step as the construction of your piece of furniture is progressing.

Regroupez toutes les quincailleries requises pour chaque étape de façon à vous assurer de tout installer au bon moment.

Reúna todas las quincallas necesarias para cada una de las etapas de montaje, para asegurar una correcta instalación en el momento adecuado.

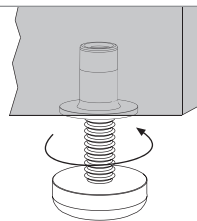

PA-844

To level your furniture, use leg levelers.

Pour niveler votre meuble utilisez les pattes ajustables.

Para nivelar su mueble utilice las patas ajustables.

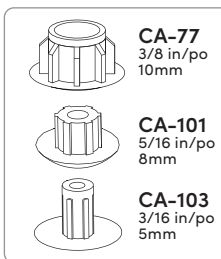
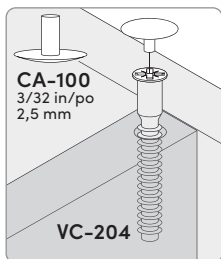
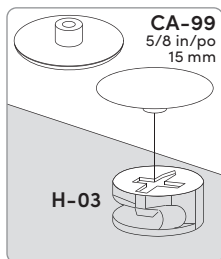

Unused holes
Perçages non utilisés
Orificios no utilizados

When you have completed the assembly of your new furniture, install plastic caps

Lorsque vous avez complété l'assemblage de votre meuble, installez les capuchons de plastique

Una vez que haya completado el ensamble del mueble, coloque los capuchones de plástico

Important Notice • Note importante • Nota importante

Duly complete the self-adhesive sticker. • Assurez-vous de bien remplir l'autocollant. • Asegúrese de completar correctamente la etiqueta.



BESTAR
Reinvent your space™

http://bestar.ca
http://bestar.com

MODEL • MODELE • MODELO
52414-1

COLOR • COULEUR • COLOR

WO

LEFT ASSEMBLY INSTRUCTIONS
INSTRUCTIONS D'ASSEMBLAGE GAUCHE
INSTRUCCIONES DE ENSAMBLAJE IZQUIERDA

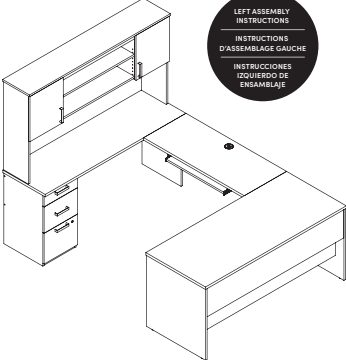

Video assembly guides
Guides d'assemblage en vidéo
Instrucciones de ensamblaje de video
www.bestar.com/video-assembly-guides

SERVICE • SERVICIO
1-888-8BESTAR (1-888-823-7827)



BESTAR

To better serve you!
Pour mieux vous servir!

Model / Modèle: _____

Production Number
Numéro de production: _____

Customer Service
Service à la clientèle **1-888-823-7827**

Important Notice • Note importante • Nota importante

For future reference and to allow us to serve you better, please complete the self-adhesive sticker and apply it in an accessible space such as under shelf.

Pour que nous puissions mieux vous servir en cas de besoin, veuillez compléter l'autocollant et l'apposer dans un endroit facilement accessible tel que le dessous d'une tablette.

Para futuras referencias y un mejor servicio, por favor pegue la etiqueta adhesiva en un espacio accesible. Por ejemplo, la parte interior del estante

Tools required • Outils requis • Herramientas Necesarias

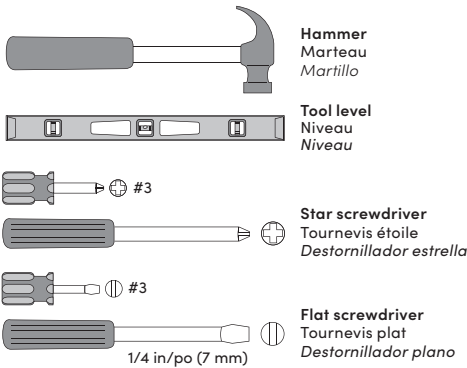

Two people are required to assemble and move this model.

Deux personnes sont requises pour assembler et déplacer ce modèle.

Se necesitan dos personas para ensamblar y desplazar este mueble.



The use of electric tools must be made with vigilance.

L'utilisation d'outils électriques doit être faite avec vigilance.

Las herramientas eléctricas deben utilizarse con sumo cuidado.

Main Hardware System. Installation Steps • Système de quincaillerie principal. Étapes d'installation • Sistema principal de quincalla. Etapas de instalación.

1

H-36

Push down
Enfoncez
Presione

Proper position
Bonne position
Buena posición

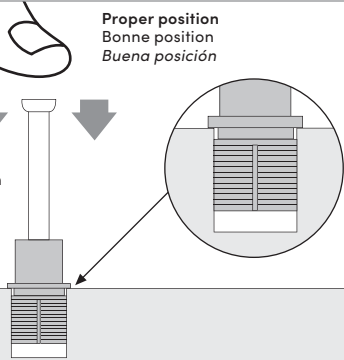

2

Arrow
Flèche
Flecha

H-03

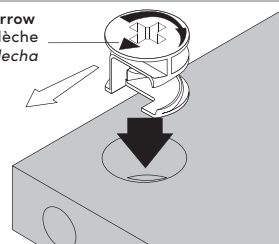

Insert the cam with the arrow pointing towards the hole in the edge.
Insérez la rondelle en pointant la flèche vers le trou de la bordure.
Inserte la arandela apuntando la flecha hacia el orificio cercano al borde.

How to remove a misplaced assembly bolt (H-36).
Comment retirer un boulon (H-36) mal situé.
Cómo retirar un perno (H-36) mal ubicado.

A

Turn
Tournez
Haga girar

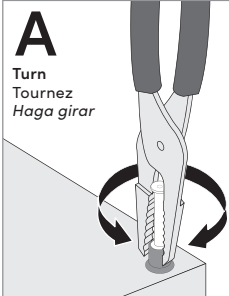

B

Pull out
Retirez
Retire

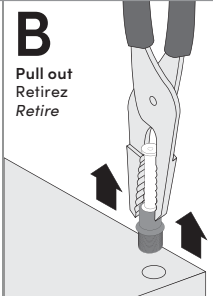

1 Hardware installation • Installation des quincailleries • *Instalación de las quincallas*

Desk • Bureau • *Escritorio*

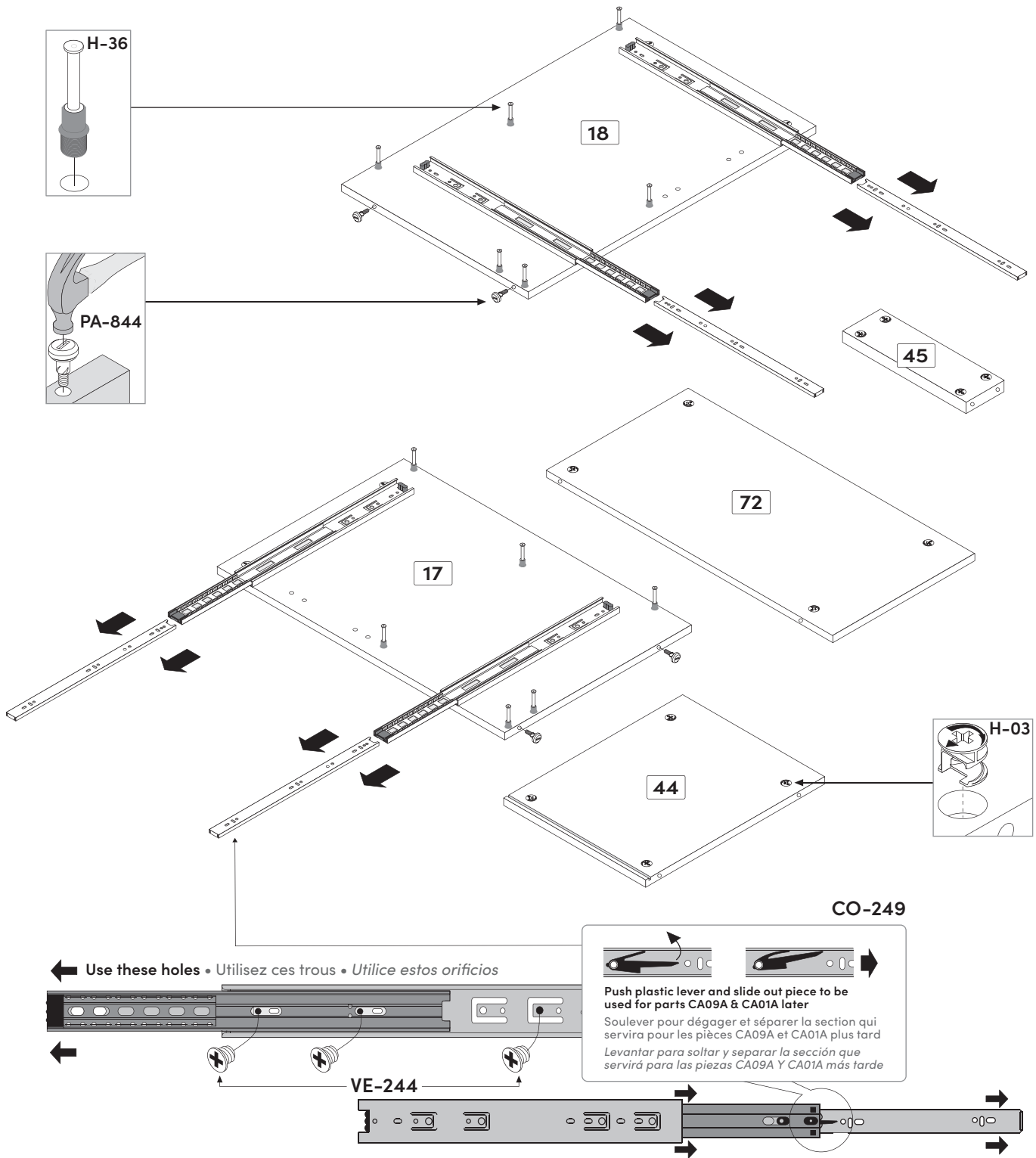

1



Code • Código

CO-249

H-03

H-36

PA-844

VE-244

Qty • Qté • Cant.

x 2

x 16

x 12

x 4

x 10

2 Assembly • Assemblage • Ensamblaje
Desk • Bureau • Escritorio



Sequence • Séquence • Secuencia

18 72 45 44 17

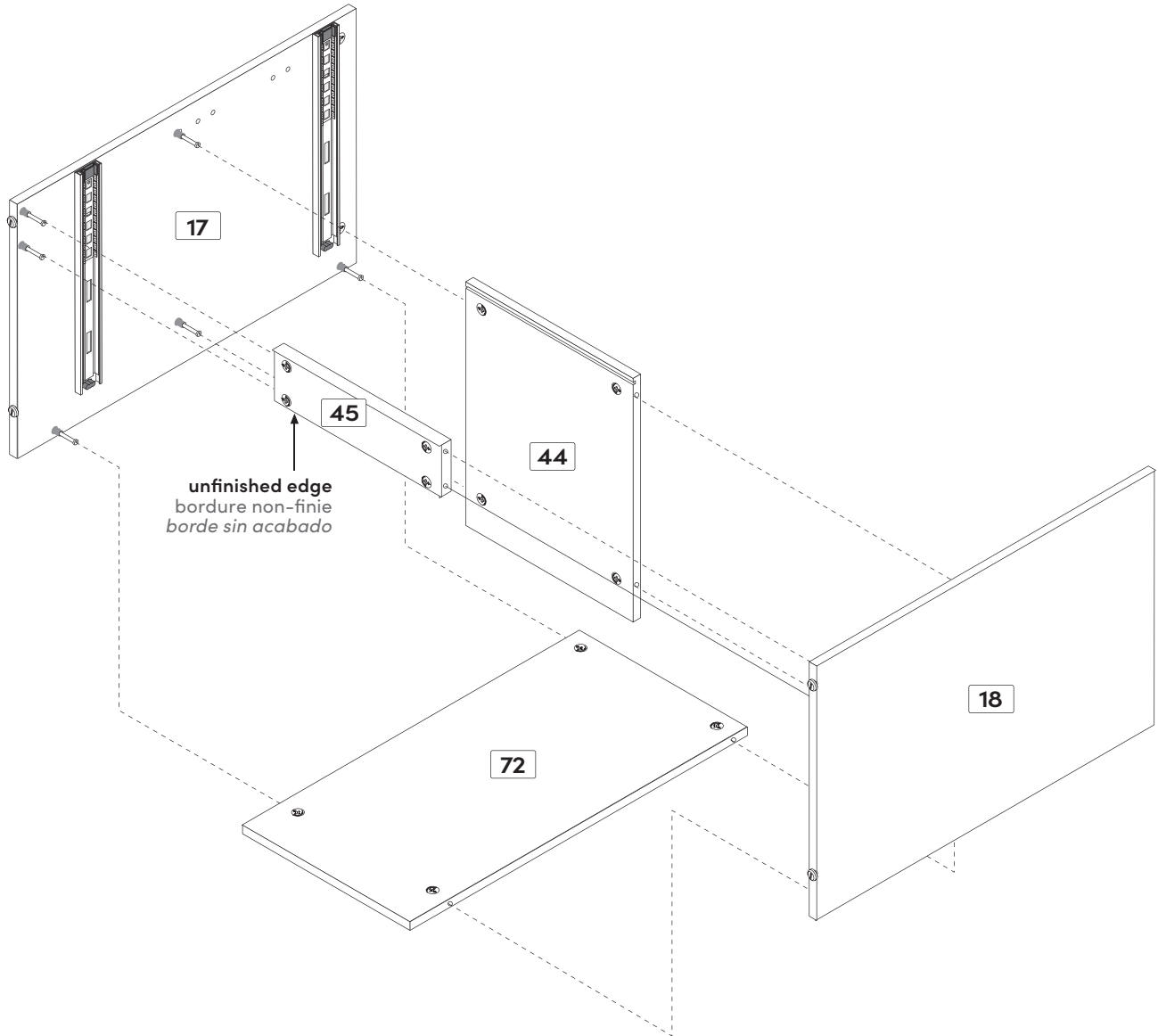

3

Hardware installation & assembly • Installation des quincailleries et assemblage • Instalación de las quincailas y ensamblaje
 Desk • Bureau • Escritorio



Sequence • Séquence • Secuencia

17 18 70 + 30 40

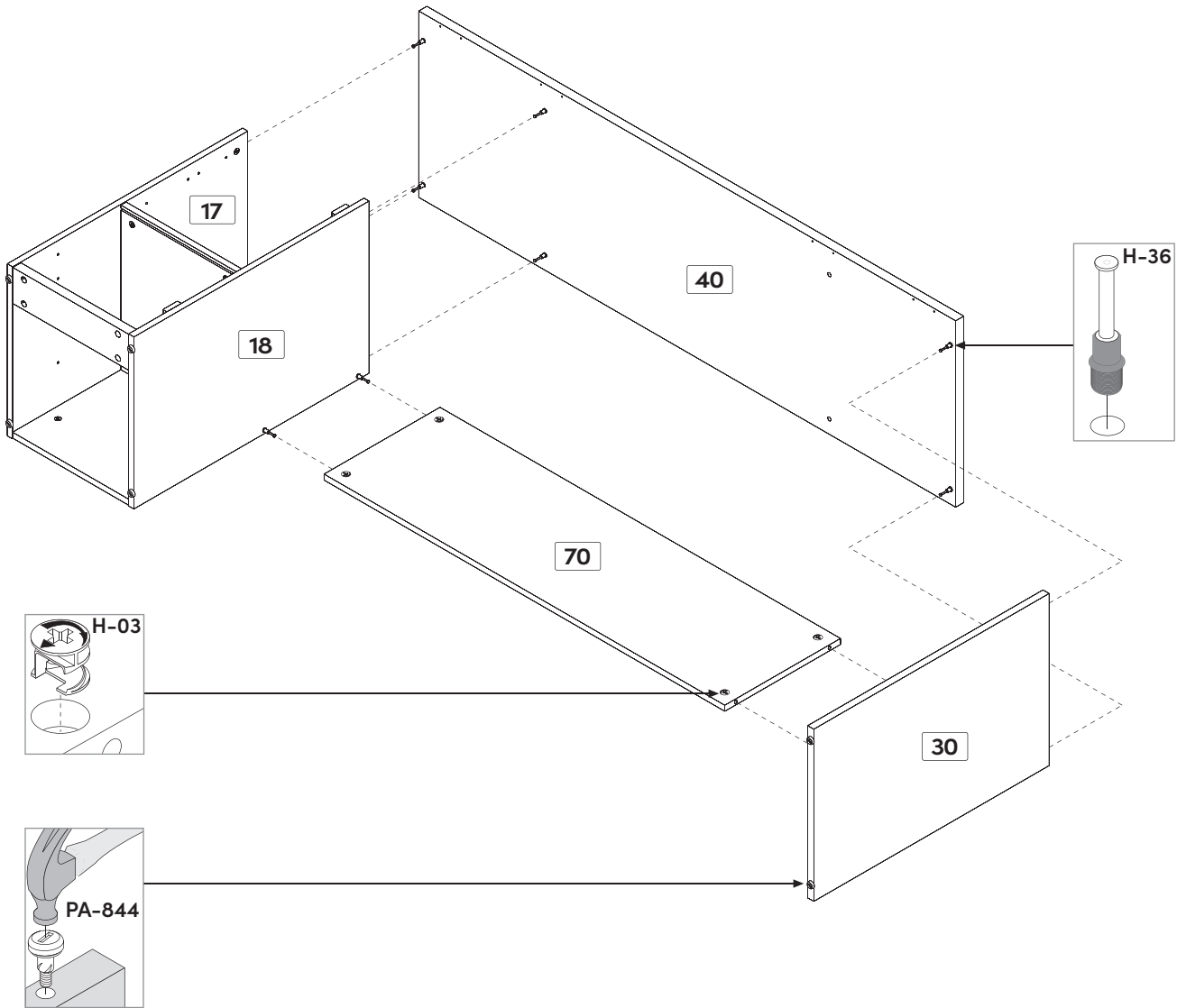

3



H-03

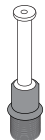

H-36



PA-844

1 in/po (25 mm)

Code • Código

Qty • Qté • Cant.

x 6

x 10

x 2

4 Hardware installation & assembly • Installation des quincailleries et assemblage • *Instalación de las quincallas y ensamblaje*
Conference table • Table de conférence • *Mesa de conferencia*



Sequence • Séquence • *Secuencia*

42 32 73 73 33

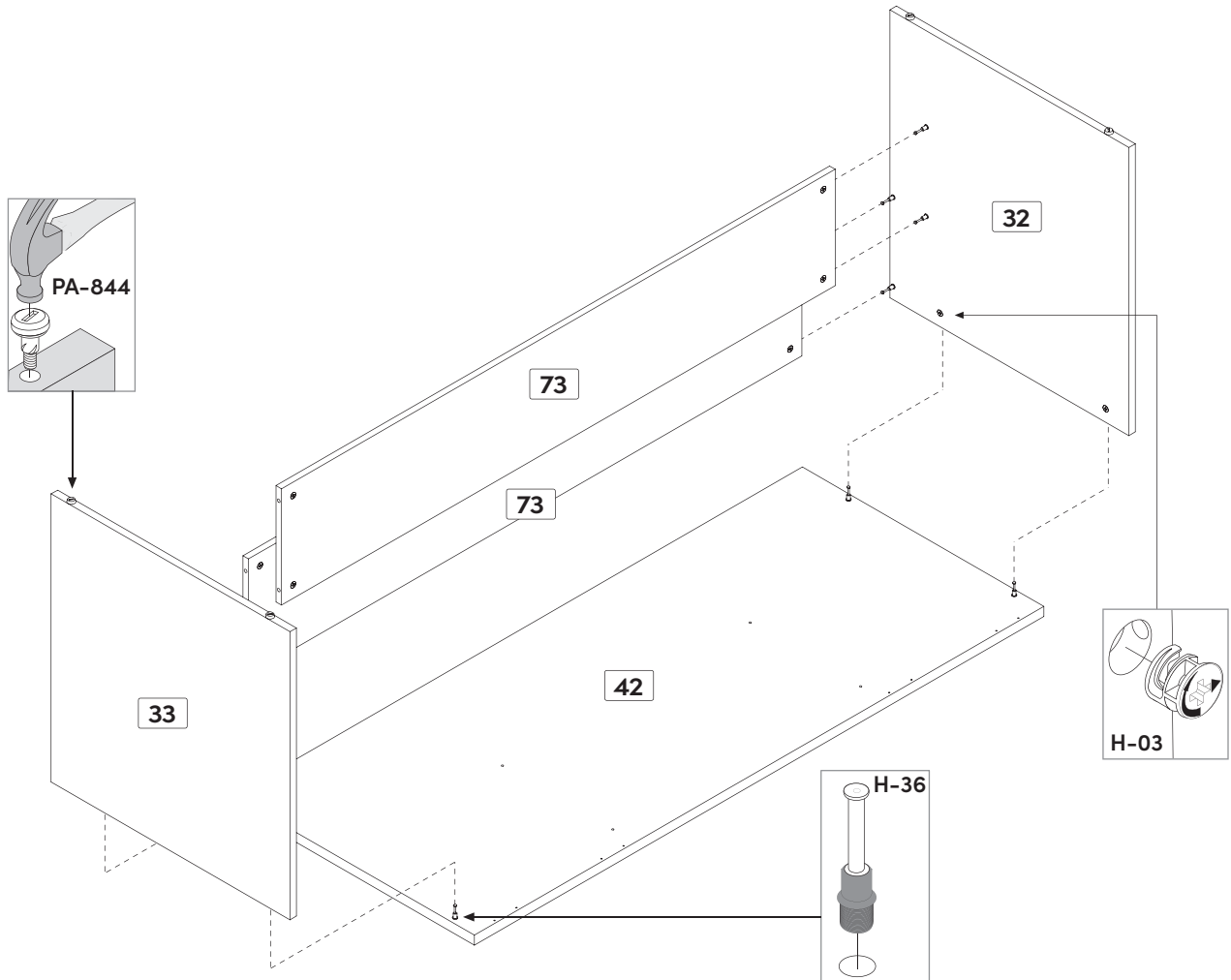

4			
Code • Código	H-03	H-36	PA-844
Qty • Qté • Cant.	x 12	x 12	x 4
			1 in/po (25 mm)

5 Hardware installation & assembly • Installation des quincailleries et assemblage • *Instalación de las quincaillas y ensamblaje*
 Bridge • Pont • Puente

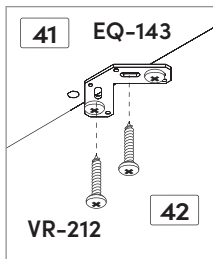
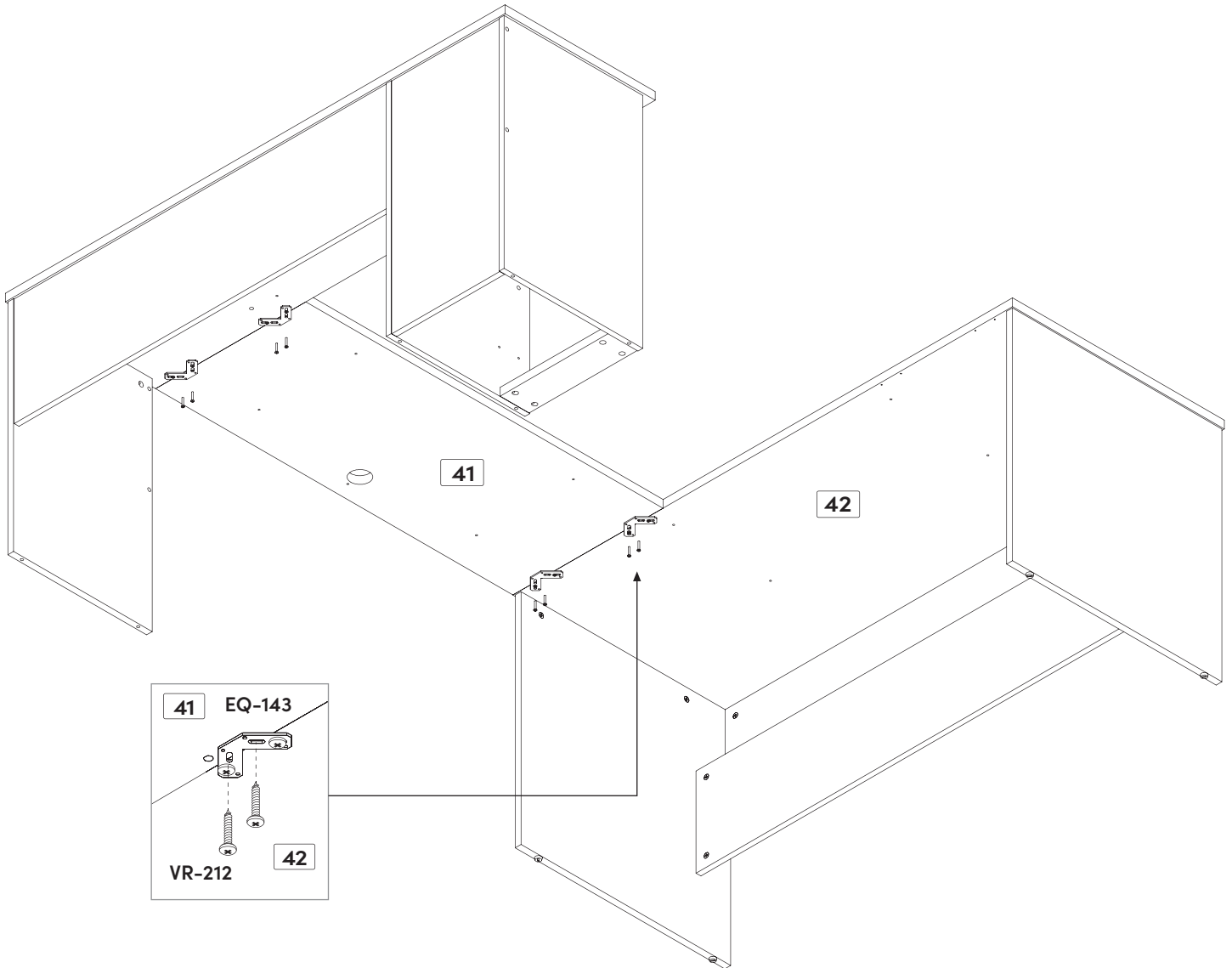

5

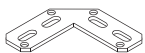

Code • Código EQ-143 VR-212

Qty • Qté • Cant. x 4 x 16



U-Shaped

Configuration en U
 Configuración en U

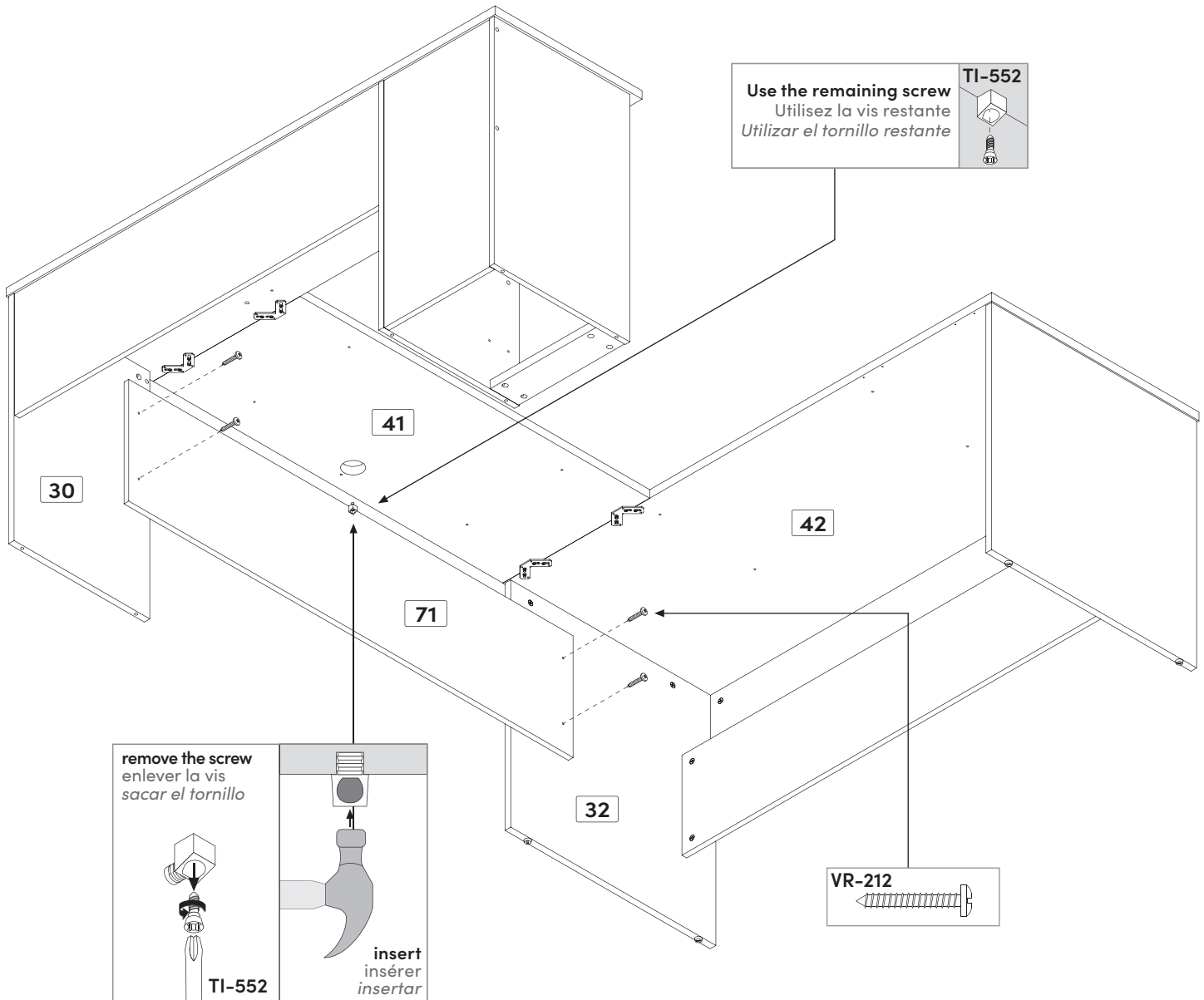

remove the screw
 enlever la vis
 sacar el tornillo

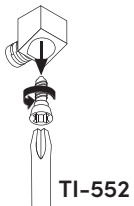

TI-552

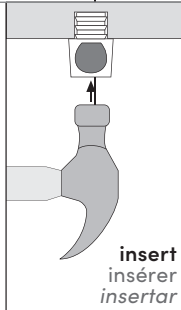

insert
 insérer
 insertar

VR-212



Code • Código TI-552

Qty • Qté • Cant. x 1



VR-212

x 4

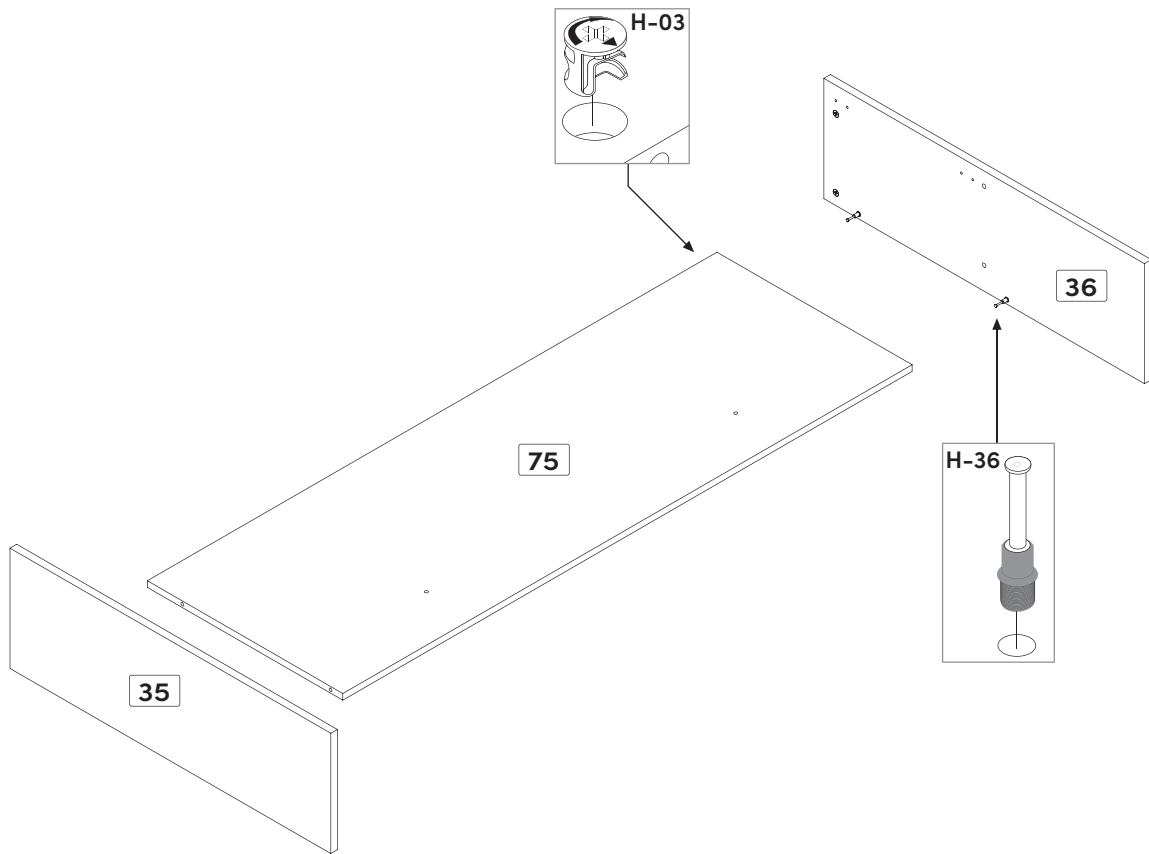

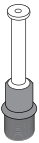
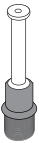
7		
Code • Código	H-03	H-36
Qty • Qté • Cant.	x 8	x 4



Sequence • Séquence • Secuencia

20 47 + 21 47 + 75 35 36

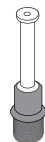
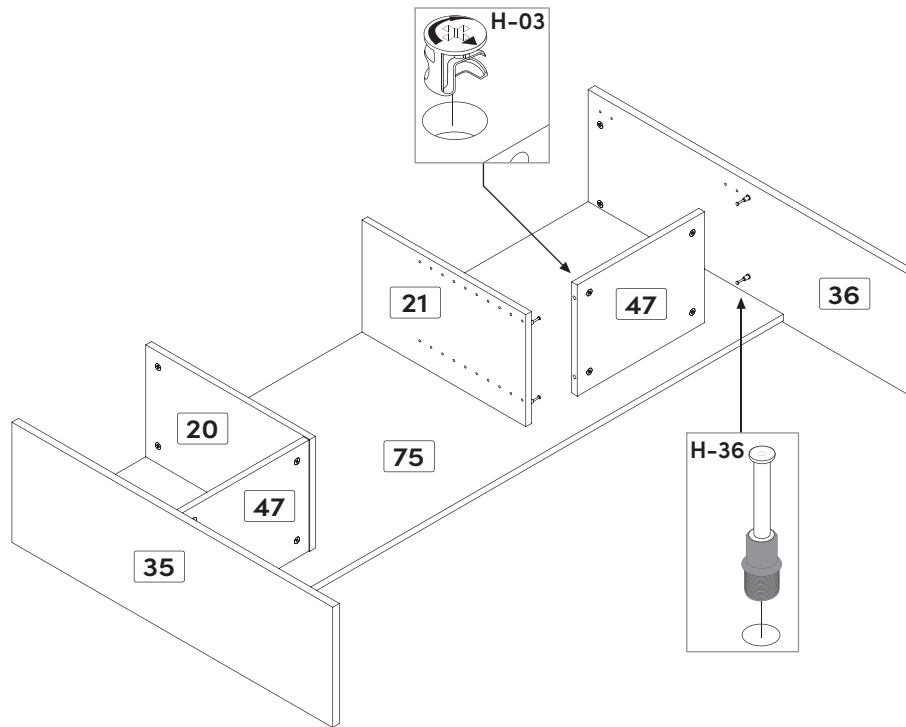

Code • Código

H-03

H-36

Qty • Qté • Cant.

x 12

x 8



Sequence • Séquence • Secuencia

49 82

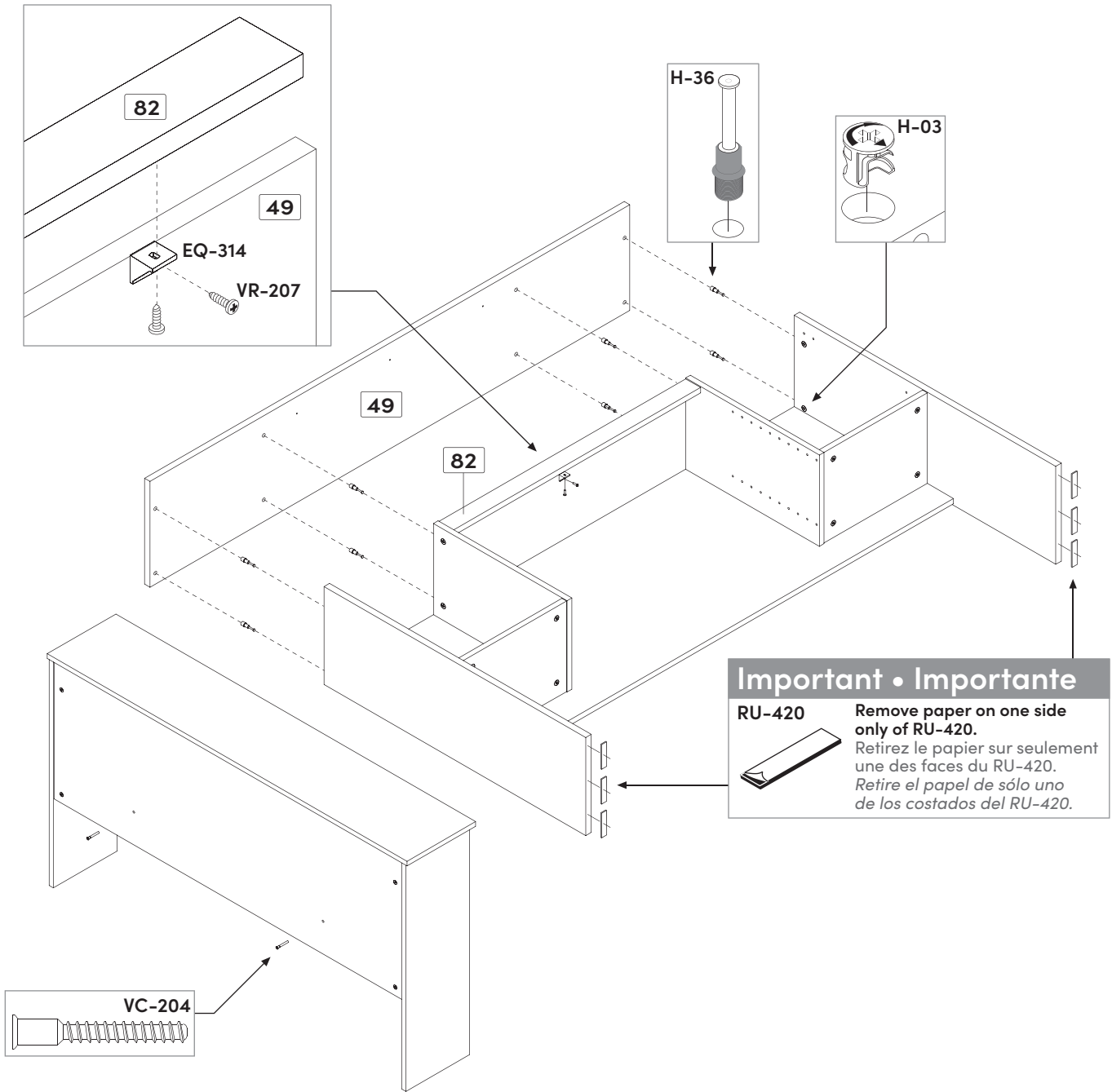

Important • Importante

RU-420 Remove paper on one side only of RU-420.
Retirez le papier sur seulement une des faces du RU-420.
Retire el papel de sólo uno de los costados del RU-420.

Code • Código	EQ-314	H-36	RU-420	VC-204
Qty • Qté • Cant.	x 3	x 8	x 2	x 2
			2 in/po (50 mm)	1/2 in/po (13 mm)

10 Installation • Installation • Instalación
Hutch • Étagère • Estantería



Sequence • Séquence • Secuencia

35 36 + 40

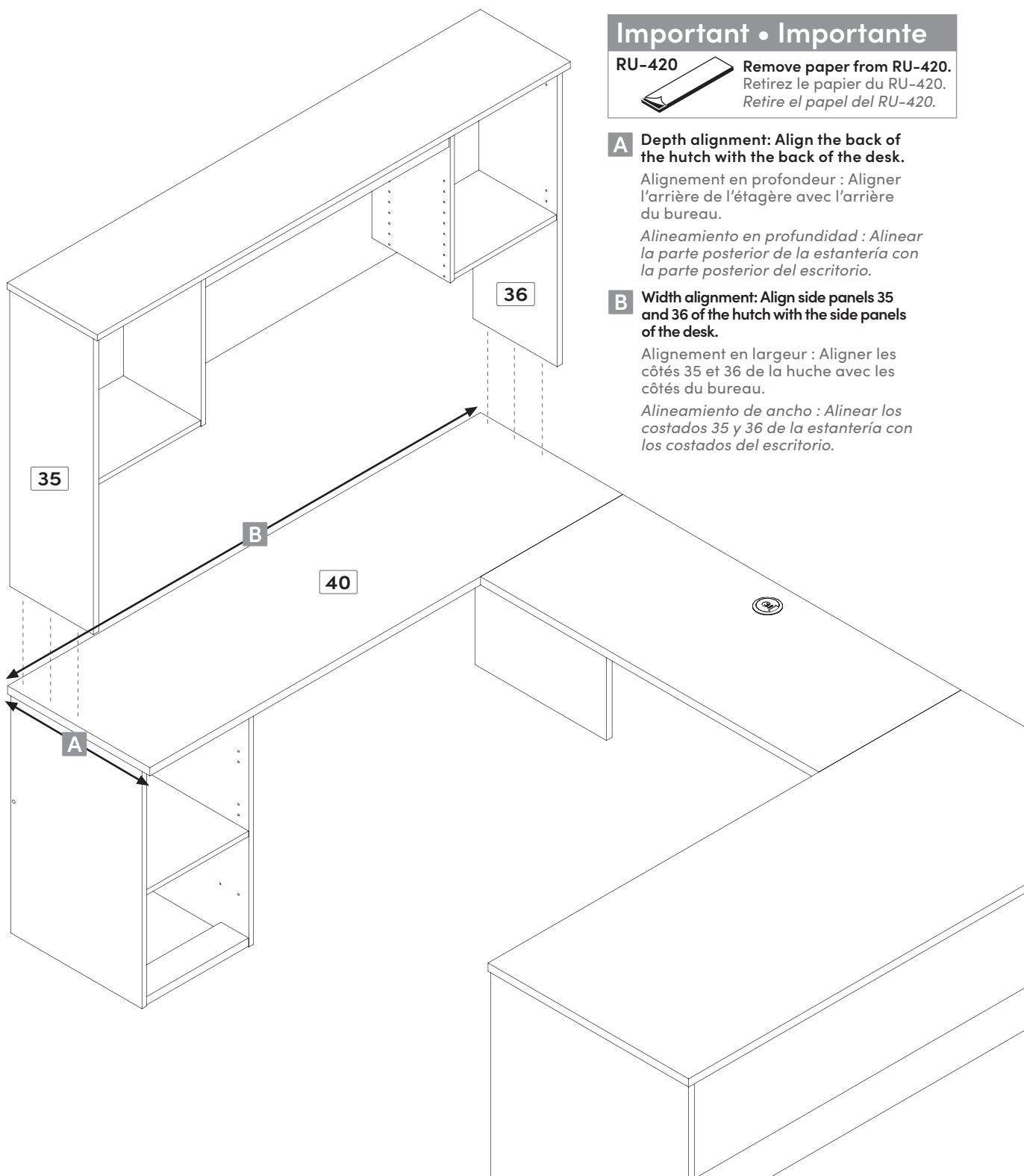

Important • Importante

RU-420  **Remove paper from RU-420.**
Retirez le papier du RU-420.
Retire el papel del RU-420.

A **Depth alignment: Align the back of the hutch with the back of the desk.**

Alignement en profondeur : Aligner l'arrière de l'étagère avec l'arrière du bureau.

Alineamiento en profundidad : Alinear la parte posterior de la estantería con la parte posterior del escritorio.

B **Width alignment: Align side panels 35 and 36 of the hutch with the side panels of the desk.**

Alignement en largeur : Aligner les côtés 35 et 36 de la huche avec les côtés du bureau.

Alineamiento de ancho : Alinear los costados 35 y 36 de la estantería con los costados del escritorio.

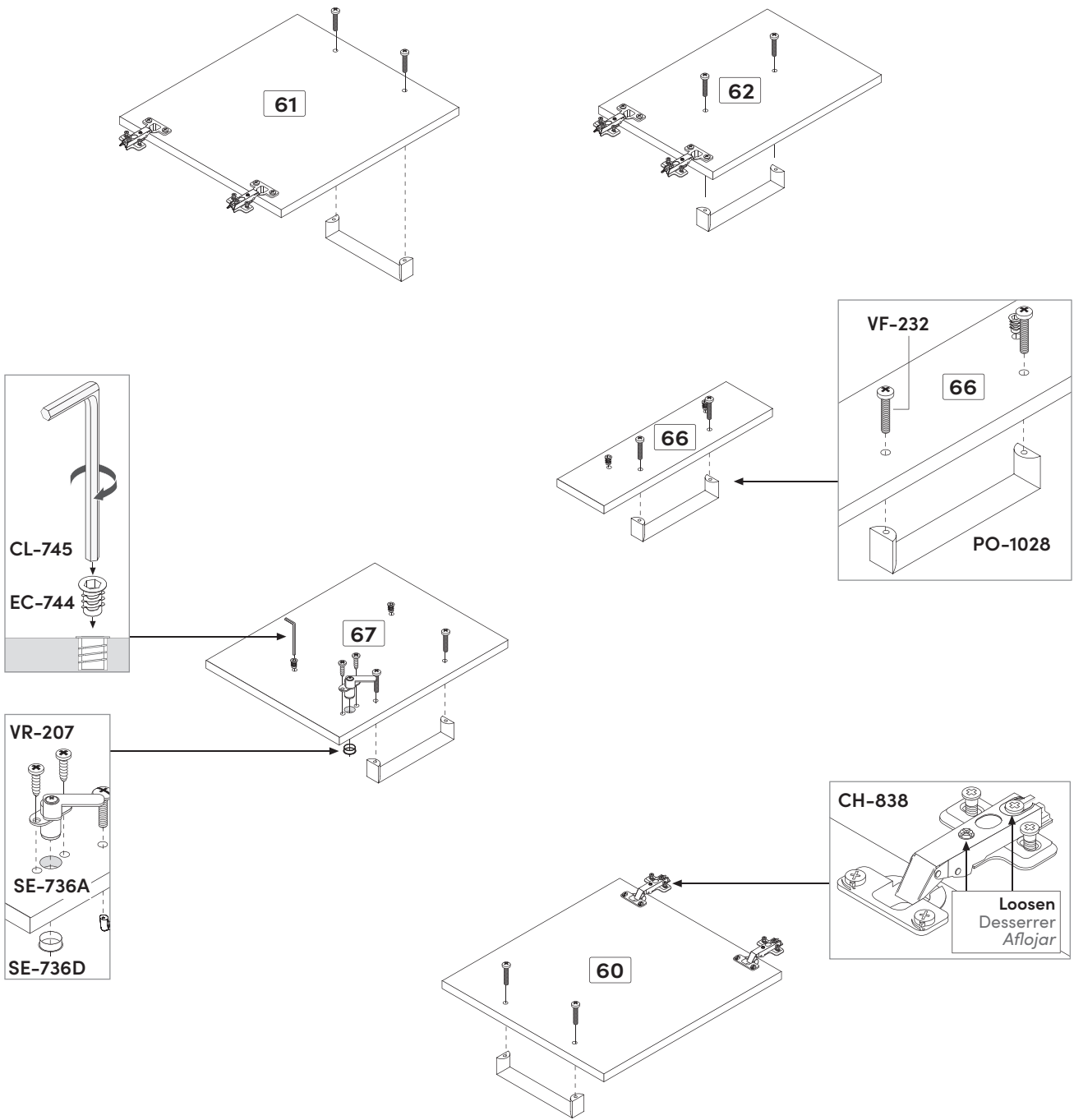

Code • Código	EC-744	CL-745	CH-838	SE-736	SE-736	PO-1028	VR-207	VF-232
Qty • Qté • Cant.	x 4	x 1	x 6	x 1	x 1	x 5	x 2	x 10





not used / non-utilisé / no utilizado

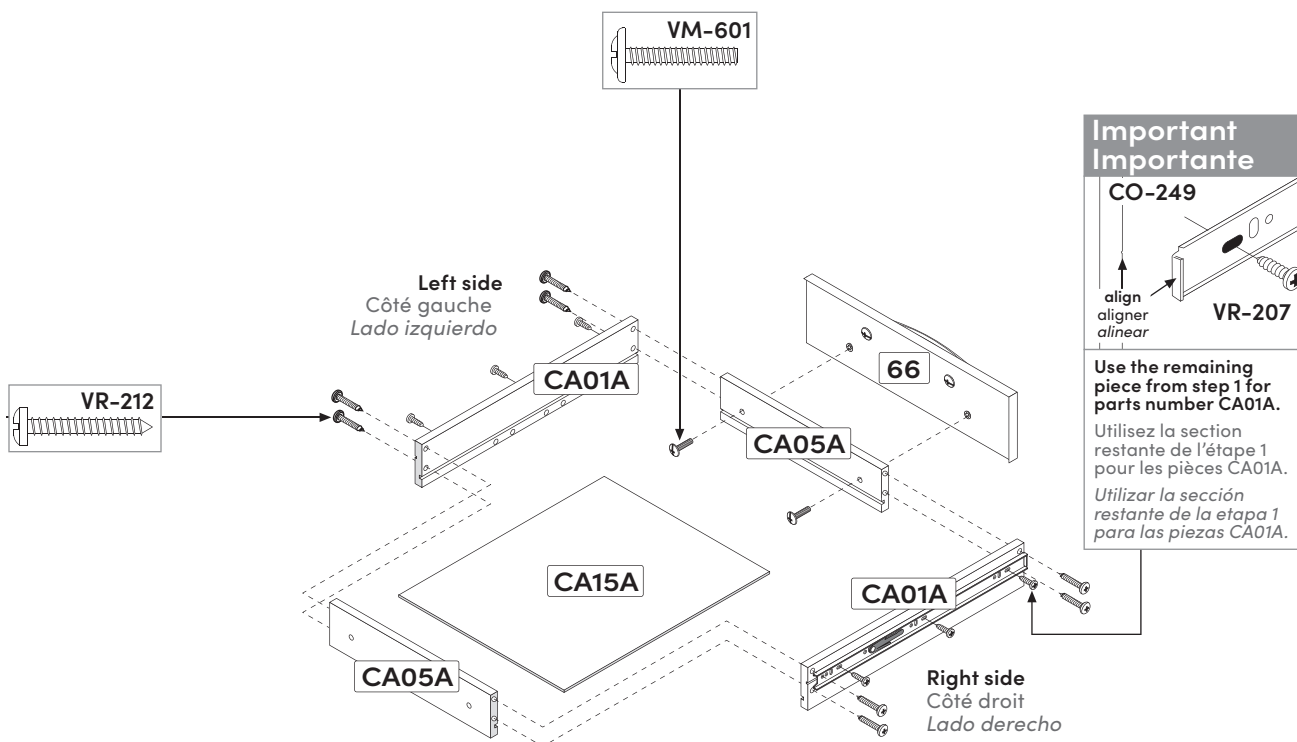

Sequence • Séquence • Secuencia

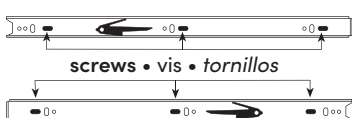
CA05A CA01A CA01A + CA15A + CA05A 66



Code • Código	Qty • Qté • Cant.
 screws • vis • tornillos CO-249	x 1
 1/2 in/po (13 mm) VR-207	x 6
 3/4 in/po (20 mm) VM-601	x 2
 1 in/po (25 mm) VR-212	x 8



Sequence • Séquence • Secuencia

CA13A EX-743 + CA09A EX-743 + CA09A EX-743 +
 CA15A + CA13A EX-743 + 67

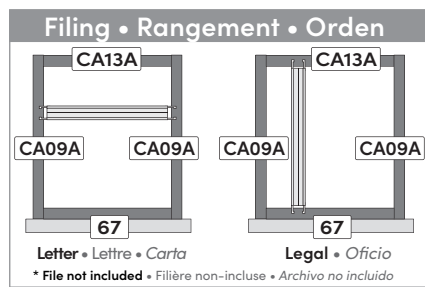
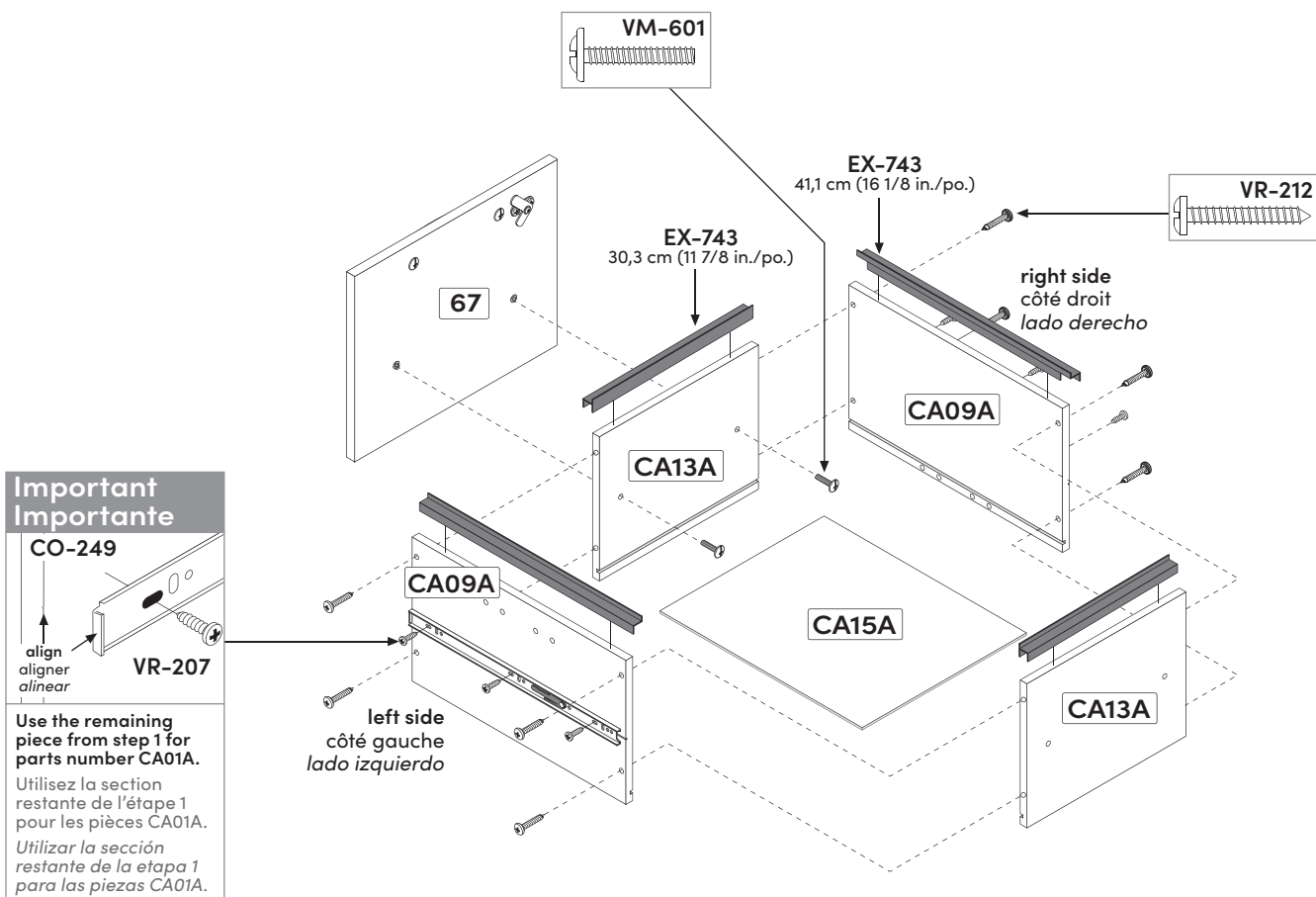

Code • Código	Qty • Qté • Cant.	Part	Qty	Part	Qty	Part	Qty	Part	Qty
CO-249	x 1	EX-743	x 2	VR-207	x 6	VM-601	x 2	VR-212	x 8
		11 7/8 in./po (303 mm)		1 7/8 in./po (411 mm)		1/2 in./po (13 mm)		3/4 in./po (20 mm)	
								1 in./po (25 mm)	

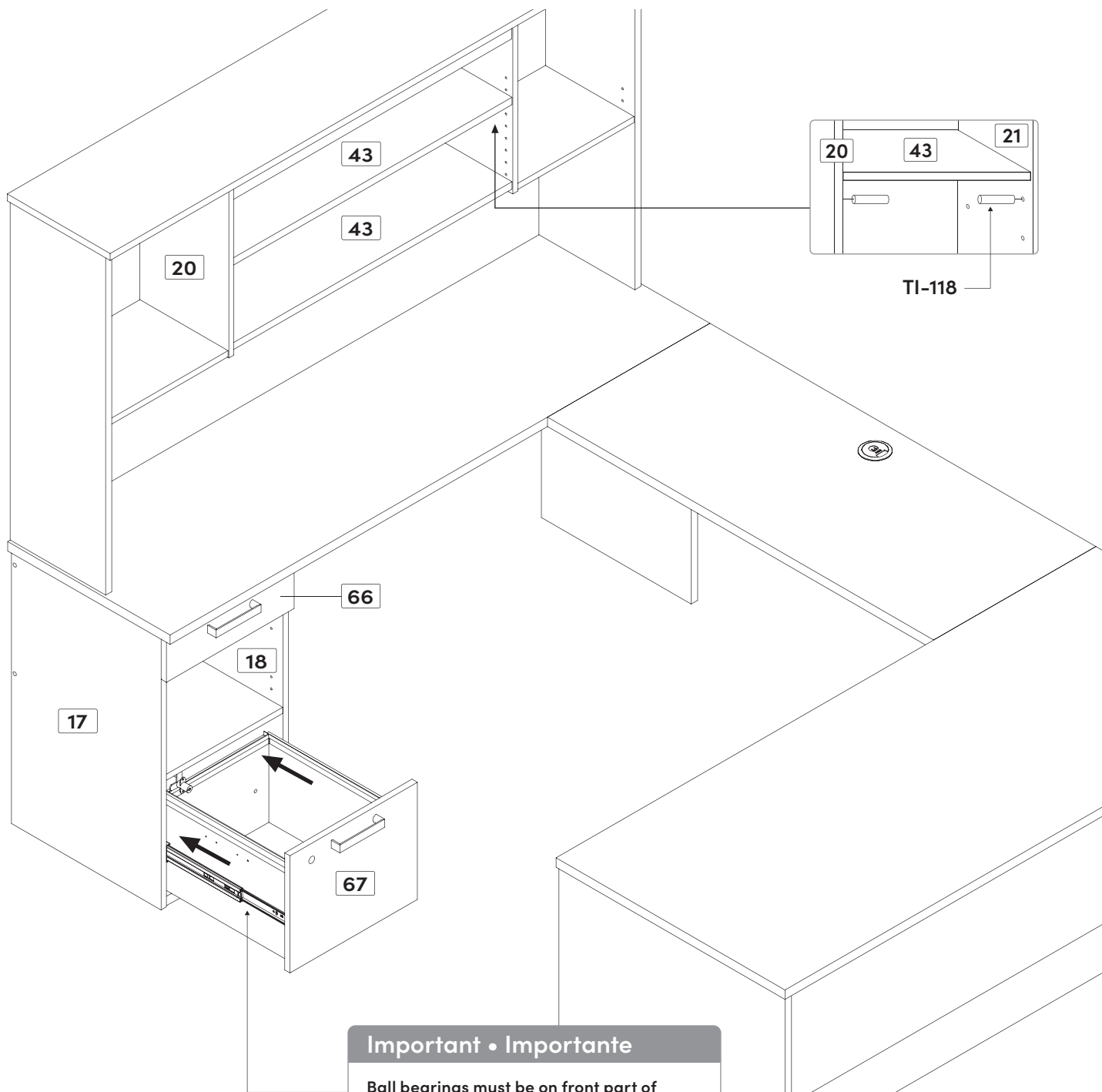

Important • Importante

Ball bearings must be on front part of slider when installing drawers.
 Les roulements à billes doivent être sur la partie avant du coulisseau lors de l'installation des tiroirs.
 Los cojinetes de bolas deben ubicarse sobre la parte delantera de guía en el momento de instalar los cajones.

CO-249

14

Code • Código **TI-118**
 Qty • Qté • Cant. **x 8**

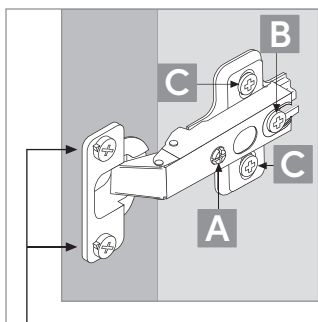

Use screw A for horizontal adjustment, screw B for depth adjustment and screws C for vertical adjustment.
 Utilisez la vis A pour l'ajustement horizontal, les vis B pour l'ajustement en profondeur et les vis C pour l'ajustement vertical.
 Utilice el tornillo A para realizar el ajuste horizontal, los tornillos B para el ajuste de profundidad y los tornillos C para el ajuste vertical.

To remove hinges, start by loosening these two screws to free the locking system.
 Pour enlever les pentures, desserrez ces deux vis d'abord pour libérer le système de verrouillage.
 Para retirar las bisagras, afloje primero estos dos tornillos para liberar el sistema de fijación.

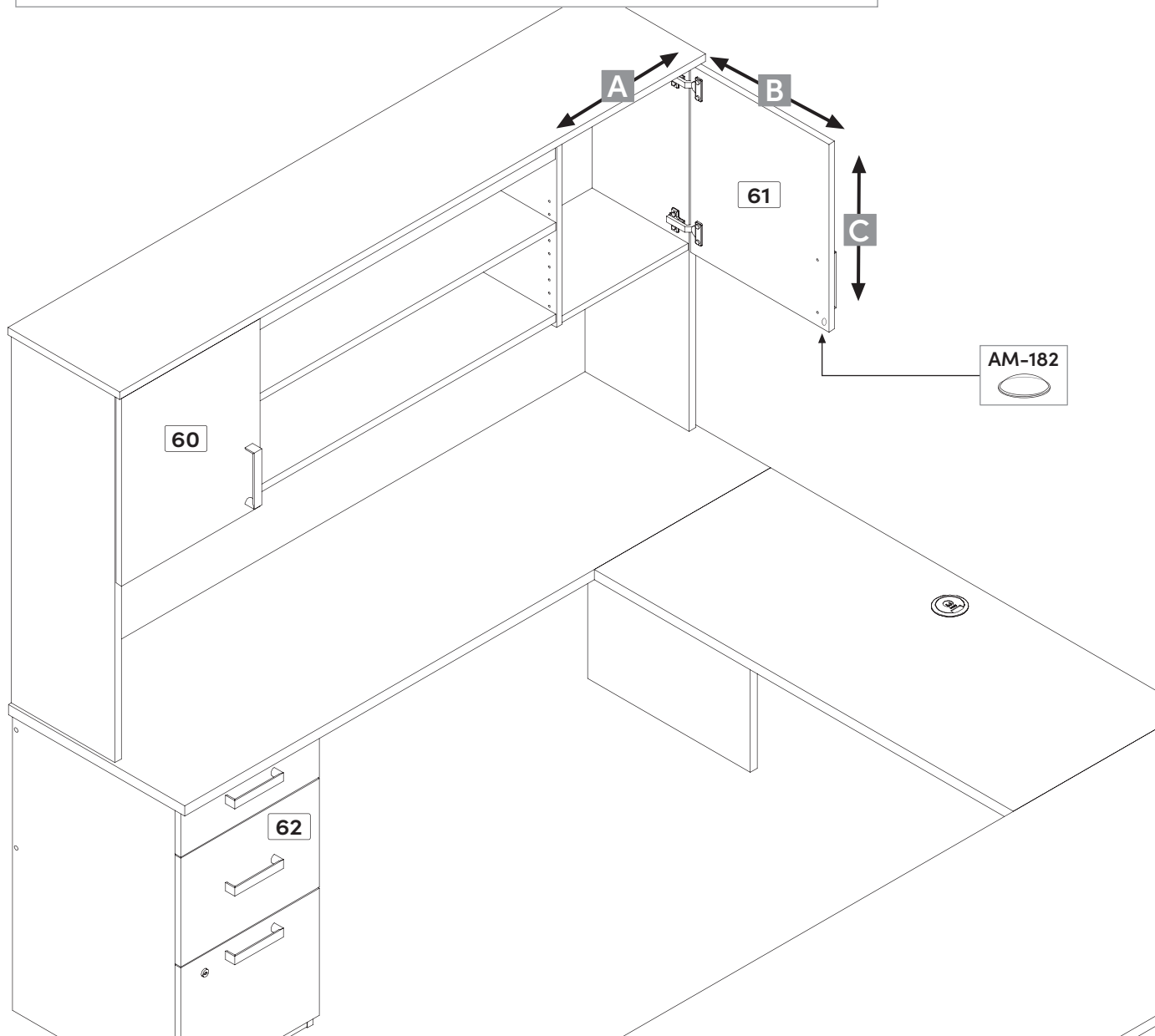

15

1/16 in./po (2 mm)

Code • Código **AM-182**

Qty • Qté • Cant. **x 4**

To level your furniture, use leg levelers.
 Pour niveler votre meuble utilisez les pattes ajustables.
 Para nivelar su mueble utilice las patas ajustables.

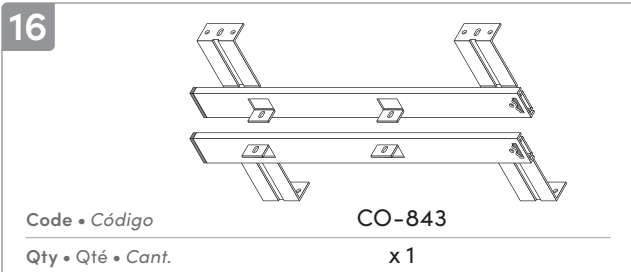
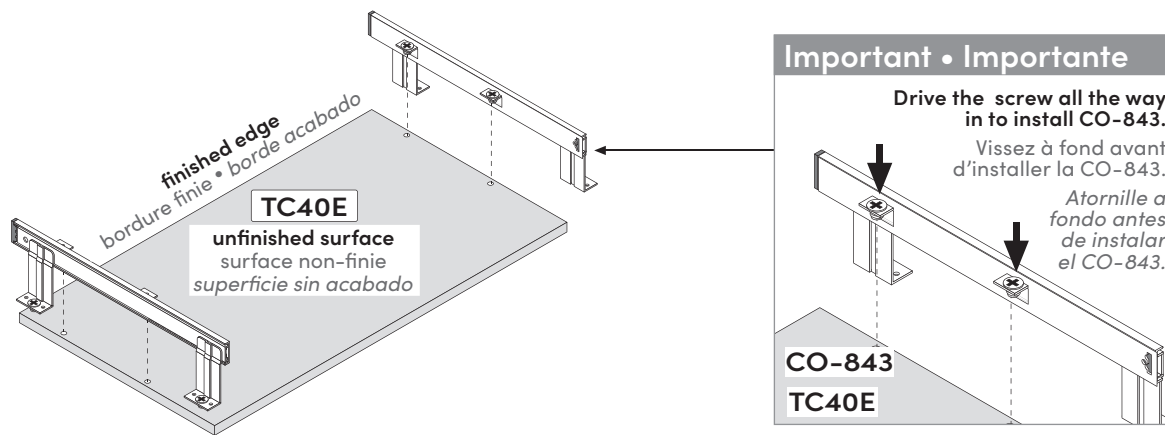

Important • Importante

3 possibilities • 3 possibilités • 3 posibilidades

