

SIDES	BOTTOM
Material: Steel-0.150"-C1008~C1018, Zinc plated	

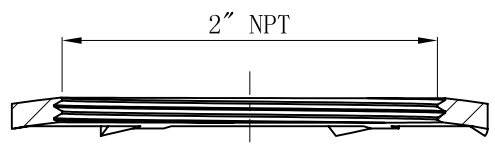
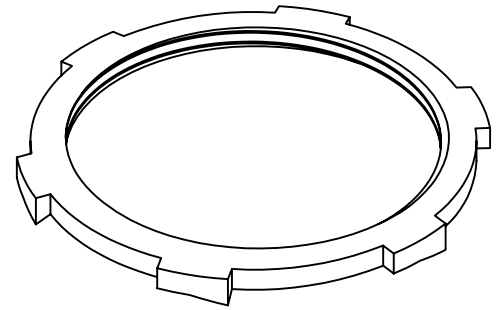
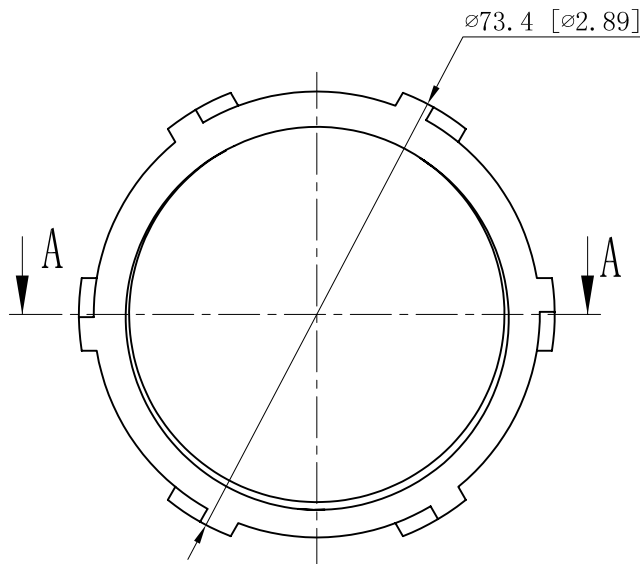

CUTAWAY VIEW A-A

This data sheet is for reference only .GARVIN INDUSTRIES reserves the right to make changes to the design without prior notice.

DESCRIPTION
TRADE REFERENCE TERMS

STANDARD PACKING
10 PCS

GARVIN INDUSTRIES		
TITLE STEEL LOCKNUTS		
SIZE A4	DWG NO. LN-200	REV
DATA SHEET		