









## Assembly Instructions, #10532 Laurent Hall Stand

A: Top Assembly	
B: (4) Legs	
C: Shelf	
D: (8) Bolts	
E: (8) Flat Washers	
F: (8) Lock Washers	
G: Allen Wrench	
H: (4) Shelf supports	

### Step 1

Fasten four legs with (8) bolts, flat washers and lock washers.

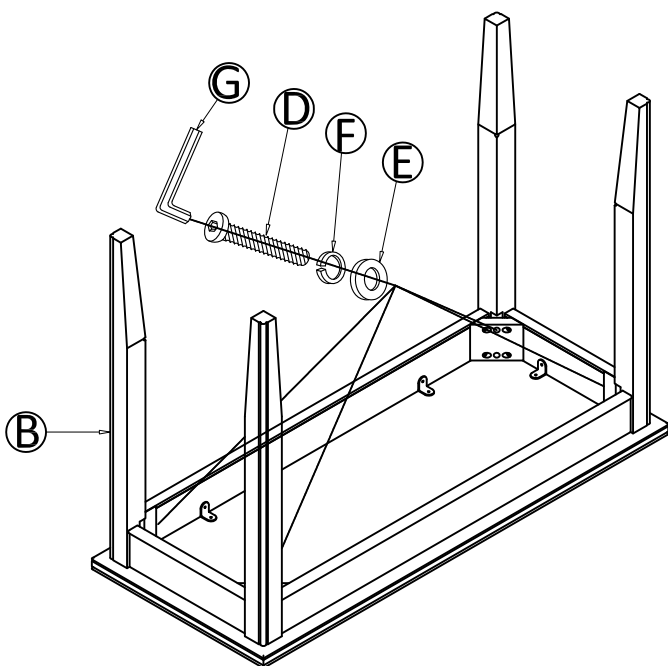

### Step 2

Place table upright and place the shelf onto the shelf supports. It helps to slip the shelf up from the bottom and insert supports from the underneath.

