

SIDES	BOTTOM
Material: Steel-Welding tube, zinc plated	

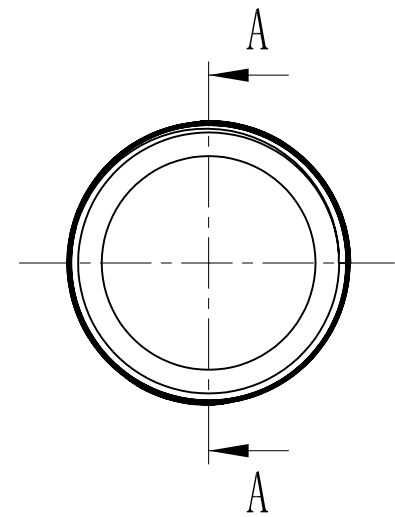
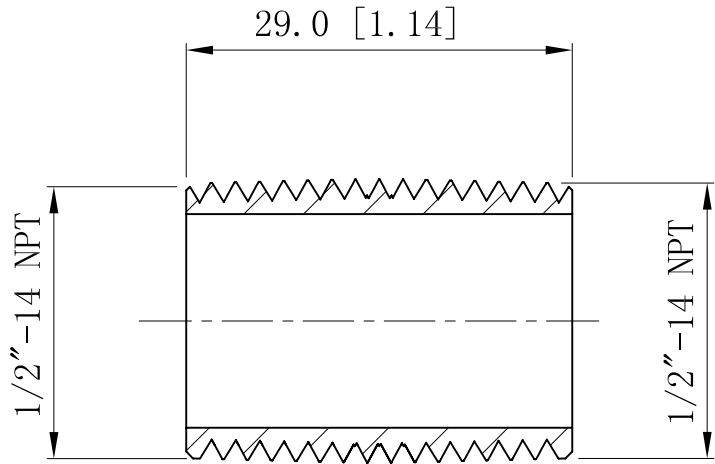

CUTAWAY VIEW A-A

This data sheet is for reference only .GARVIN INDUSTRIES reserves the right to make changes to the design without prior notice.

DESCRIPTION
TRADE REFERENCE TERMS

STANDARD PACKING
25 PCS

GARVIN INDUSTRIES		
TITLE RIGID CONDUIT NIPPLES		
SIZE A4	DWG NO. RN50C	REV
DATA SHEET		