

evenflo®

Symphony™ All-in-One Child Restraint System

Owner's Manual

Keep for future use.

Rear-facing*

2.3 to 18 kg
(5 to 40 lbs)

48 to 102 cm
(19 to 40 in.)

Forward-facing*

10 to 29.4 kg
(22 to 65 lbs)

71 to 127 cm
(28 to 50 in.)

Booster*

18 to 49.8 kg
(40 to 110 lbs)

112 to 145 cm
(44 to 57 in.)

At least 4 years old



* See inside cover for complete requirements.

Para instrucciones en Español,
llamar al: 1-800-233-5921.

⚠️ WARNING:

To reduce the risk of serious injury
or death, read this owner's manual prior
to installing and using this child restraint.

More children are killed every year as passengers in car crashes than by any other type of injury.

To reduce the risk of **SERIOUS INJURY** or **DEATH**, read this owner's manual and your vehicle owner's manual before installing and using this child restraint. Using a child restraint makes a big difference. By properly using this child restraint and following these instructions (and the instructions that accompany your vehicle), you will greatly reduce the risk of serious injury or death to your child from a crash. Do not be misled by the commonly used term "safety seat"; no restraint system can prevent all injuries in all crashes. Many properly restrained adults and children are injured in motor vehicle crashes, including relatively minor crashes. A properly used child restraint is the best way to minimize injuries to your child and to increase the chances for your child's survival in most crashes.

U.S. REGULATORY NOTICE

This child restraint meets all applicable requirements of Federal Motor Vehicle Safety Standard 213.

CANADIAN REGULATORY NOTICE (Model numbers ending in "C.")

This child restraint meets all applicable requirements of Canadian Motor Vehicle Safety Standards CMVSS 213, 213.1, and 213.2.

Child Requirements

- No restraint can guarantee absolute protection from injury in every crash.
- This child restraint is designed for use by children in rear-facing, forward-facing, and booster modes.
- To use this child restraint properly, children **MUST** meet weight/size specifications as follows:

For Rear-facing Use

- The child weighs 2.3 to 18 kg (5 to 40 lbs).
- The child is 48 to 102 cm (19 to 40 inches) **AND** the top of child's head is at least 25 mm (1 inch) **below the top** of the child restraint headrest in either of its two lowest positions.

For Forward-facing Use

- The child weighs 10 to 29.4 kg (22 to 65 lbs).
- The child is 71 to 127 cm (28 to 50 inches) **AND** the tops of their ears are below the top of the child restraint headrest.
- Child is one year old or older.

For Booster Use

- The child weighs 18 to 49.8 kg (40 to 110 lbs).
- The child is 112 to 145 cm (44 to 57 inches) **AND** the tops of their ears are below the top of the child restraint headrest.
- Child is four years old or older.

Table of Contents

Important Information

Warnings	2
Safe Practices	9
Recall Information for U.S. Customers	10
Public Notice for Canadian Customers	10
Motor Vehicle/Aircraft Usage.....	10
Symbol Legend	11
Storing Your Instructions	11
Visual Glossary	12
Securing the Child in the Child Restraint.....	16
Removing the Child from the Child Restraint	18

Rear-facing Use

Rear-facing Installation Checklist	21
Which Type of Lower Anchor Connector Is on Your Child Restraint?	22
Moving Lower Anchor Connector Assembly to Rear-facing Belt Path	22
Rear-facing Installation with Lower Anchor Connectors.....	25
Rear-facing Installation with Seat Belt.....	28

Forward-facing Use

Forward-facing Installation Checklist	33
Which Type of Lower Anchor Connector Is on Your Child Restraint?	34
Moving Lower Anchor Connector Assembly to Forward-facing Belt Path	34
Forward-facing Installation with Lower Anchor Connectors.....	37
Forward-facing Installation with Seat Belt.....	42

Booster Use

When to Put Your Child in a Booster Seat.....	48
Booster Installation Checklist.....	51
Converting into a Booster Seat.....	52

General Information

Using the SureLatch® Connectors.....	56
Using the Quick Connectors™	56
Removing the Tether Strap.....	57
Adjusting the Headrest.....	58
Adjusting the Recline Position	58
Removing the Seat Pad	59
Installing the Accessories.....	60
Securing Your Child Restraint in Aircraft	62
Installing Child Restraint Rear-facing in Aircraft	62
Installing Child Restraint Forward-facing in Aircraft	64
Care and Cleaning	67
Replacement Parts	69
Limited Warranty	70

⚠️ WARNING

Air Bag Warnings

Rear-facing, Forward-facing, and Booster Use

- **DO NOT** use this child restraint in the front seat of a vehicle equipped with an air bag, unless the air bag has been deactivated. Interaction between a rear-facing restraint and air bags may cause serious injury or death. Air bags may cause serious injury or death to children 12 and under.

If your vehicle has an air bag, refer to your vehicle owner's manual for child restraint installation.

- If the rear seat of your vehicle is equipped with side air bags, refer to the following information for proper usage.

Vehicles built prior to the 2002 model year:

DO NOT use this restraint in a vehicle seating position equipped with a side air bag unless authorized by the vehicle manufacturer.

Model year 2002 and newer vehicles:

Refer to your vehicle owner's manual before placing this restraint in a seating position equipped with a side air bag.

DO NOT place any objects between the restraint and the side air bag, as an expanding air bag may cause the items to strike the child.

The forward facing back seat is the safest place for children 12 and under.

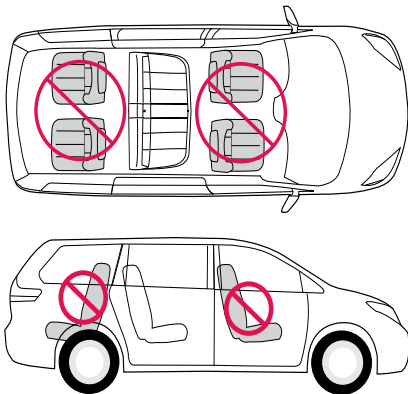

⚠️ WARNING

General Warnings

Rear-facing, Forward-facing, and Booster Use

- Failure to follow installation instructions can result in the child striking the vehicle's interior during a sudden stop or crash. Serious injury or death may result. These instructions and the instructions in your vehicle owner's manual must be followed carefully. If there is a conflict between the two, the vehicle owner's manual regarding child restraint installation must be followed.
- **NEVER** leave child unattended.
- Children have **STRANGL**ED in loose or partially buckled harness straps. Fully restrain the child.

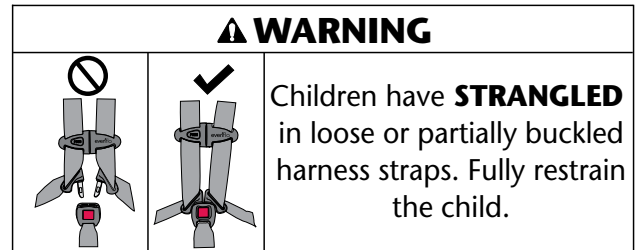

- **DO NOT** use child restraint if it is damaged, broken, or missing parts.
- **DO NOT** use this restraint if it has been involved in a crash. It must be replaced.
- **DO NOT** remove back cover.
- **NEVER** use this child restraint without the headrest installed.

Location Warnings

Rear-facing, Forward-facing, and Booster Use

- **ALWAYS** read and follow exactly the instructions that accompany your vehicle and child restraint.
- According to statistics, children are safer when properly restrained in a rear seating position than in the front seating position. Generally, the center rear position is safest and should be used if available.
- Some child restraints do not fit all vehicles or all seating locations. There are many thousands of combinations of vehicle makes, models, child restraint configurations, vehicle seat belt designs, and seat cushion shapes. The easiest way to determine whether your child restraint is suitable for a particular seating position is to check for a tight installation.

⚠WARNING

Location Warnings – continued

Rear-facing, Forward-facing, and Booster Use

If the child restraint cannot be properly installed, **DO NOT** use the child restraint. Consult vehicle owner's manual, try a different seating location, or call Evenflo for further assistance.

- **ONLY** use this child restraint on **forward-facing vehicle seats**. **DO NOT** use this restraint with vehicle seats that face the rear or side.
- **ONLY** use this child restraint on vehicle seats with backs that lock into place.

Premature Infants

Rear-facing Use Only

- **DO NOT** use this or any child restraint with a premature infant until after consulting your doctor. Premature infants may have difficulty breathing when in a seated or semi-reclined position. Using additional padding or pillows behind the infant's head or failing to properly recline the child restraint could increase the child's risk of serious injury or death.

Rear-facing Position Warnings

Rear-facing Use Only

- When using this restraint rear-facing, **DO NOT** loosen the vehicle seat belt to provide more leg room, as this will prevent the child restraint from protecting the child.
- Fold-down armrests could pose a hazard to a rear-facing child in certain types of collisions. Consult your vehicle owner's manual before installing any rear-facing child restraint in front of a fold-down armrest.
- **NEVER** turn a child restraint forward-facing with an infant who weighs less than 10 kg (22 lbs) or is less than one year of age. Crash forces may cause serious injury or death.
- **NEVER** use **Recline Position #2** or **Recline Position #3** when using this child restraint rear-facing. Use **ONLY Recline Position #1**.
- **DO NOT** use the tether strap when the child restraint is in the rear-facing position.

⚠WARNING

Rear-facing Position Warnings – continued

Rear-facing Use Only

- The headrest on the vehicle seat that the child faces when sitting in the rear-facing mode should be placed in the lowest position. The vehicle seat back that the child faces must be fully padded and free of any hard objects.

Forward-facing Position Warnings

Forward-facing and Booster Use Only

- When using the harness straps to secure a child who is more than 18 kg (40 lbs), **NEVER** place the child restraint in **Recline Position #2**. Use **ONLY Recline Position #3**.
- **DO NOT** use **Recline Position #1** or **Recline Position #2** when using this child restraint in Booster Mode. Use **ONLY Recline Position #3**.
- **DO NOT** use the Lower Anchors of the child restraint anchorage system (LATCH system) to attach this child restraint when restraining a child weighing more than 20.4 kg (45 lbs) with the internal harnesses of the child restraint.
- Install this child restraint with a vehicle seat belt (**NOT** Lower Anchor Connectors) when using the restraint's internal harnesses to secure a child who weighs more than 20.4 kg (45 lbs).
- If the child weighs more than 29.4 kg (65 lbs) **OR** their shoulders are above the highest harness level, you **MUST** use this child restraint as a booster (p. 48).
- Adjust, or remove, the **vehicle headrest, in the seat where the child restraint is to be installed**, so that the back of the child restraint rests against the vehicle seat back.
- The headrest on the vehicle seat in front of the child should be put in its lowest position. The vehicle seat back that the child faces must be fully padded and free of any hard objects.

Booster Seat Position Warnings

Booster Use Only

- **DO NOT** use this booster seat rear-facing.

⚠WARNING

Seat Belt Warnings

Rear-facing and Forward-facing Use Only

- **DO NOT** use this child restraint if it moves more than 25 mm (1 inch) side to side or front to back at either the rear-facing or forward-facing belt path on the child restraint. Serious injury or death may result from poor installation. If you cannot tightly secure the child restraint, try again or move it to another location.
- **DO NOT** use this child restraint in a seating position with door-mounted seat belts.
- **DO NOT** use this child restraint in a vehicle with seat belts that automatically move along the vehicle frame when the door is opened. These seat belts will not hold a child restraint properly.
- **DO NOT** use this child restraint in a vehicle equipped with seat belts that only lock during a sudden stop or crash (emergency locking retractor – ELR). You must use a seating location with a locking seat belt. Check your vehicle owner’s manual to see if you have seat belts with ELRs.
- If the vehicle seat belts are not routed and fastened correctly, the child restraint may not protect the child in a crash.
- **DO NOT** allow the vehicle seat belt release button to touch the child restraint. Accidental contact may cause the seat belt to release. If necessary, turn the seat belt release button away from the child restraint or move the child restraint to a different location.
- Failure to adjust the harness or vehicle seat belts snugly around the child may result in the child striking the vehicle’s interior during a sudden stop or crash. Serious injury or death may occur.

Booster Use Only

- To prevent serious injury, use **ONLY** the vehicle’s lap **AND** shoulder belt system when restraining a child in this booster seat.
- The shoulder belt **MUST** be threaded through the shoulder belt guide (p. 50).
- **DO NOT** use this booster seat if the tops of the child’s ears are above the back of the booster seat headrest.



⚠WARNING

Seat Belt Warnings – continued

Booster Use Only

- The shoulder belt **MUST NOT** cross the child’s neck **or** fall off the child’s shoulder. If you cannot adjust the shoulder belt to **properly lay midway between the child’s shoulder and neck AND at or above the shoulder**, try another seating location or do not use the booster seat.

LATCH Warnings

Rear-facing and Forward-facing Use Only

- **DO NOT** use the Lower Anchors of the child restraint anchorage system (LATCH System) to attach this child restraint when restraining a child weighing more than 20.4 kg (45 lbs) with the internal harnesses of the child restraint.
- The LATCH system is intended to be used **ONLY** as described in these instructions. Serious injury or death may result from misuse. **LATCH** (Lower Anchors and Tethers for **CH**ildren) is a system for attaching the child restraint to your vehicle seat. It can be used in place of the seat belts in vehicles with vehicle Lower Anchor Bars. Refer to your vehicle owner’s manual for the locations of the vehicle Lower Anchor Bars.
Note: Your vehicle owner’s manual may refer to this system as “Universal Anchorage System,” “Lower Universal Anchorage System,” or “ISOFIX.”
- In addition to these instructions, read and follow your vehicle owner’s manual regarding installation of the child restraint and LATCH. If there is a discrepancy, follow your vehicle owner’s manual.
- **ONLY** use for securing child restraint to vehicle Lower Anchor Bars.
- **NEVER** attach two Lower Anchor Connectors to one vehicle Lower Anchor Bar.
- **NEVER** use the vehicle seat belts when using the Lower Anchor Connector Assembly. Using both together can cause slack in a sudden stop or crash.
- When not in use, the Lower Anchor Connectors should be securely attached to the D-rings on the child restraint’s seat pad. Keep out of reach of children.

⚠WARNING

LATCH Warnings – continued

Rear-facing and Forward-facing Use Only

- **ALWAYS** be sure that the Lower Anchor Connectors are attached to the vehicle Lower Anchor Bars by pulling hard on the Lower Anchor Connectors. If they are not attached, the Lower Anchor Connector Assembly will not secure your child restraint. Serious injury or death may result.
- **DO NOT** use this child restraint if it moves more than 25 mm (1 inch) side to side or front to back at either the rear-facing or forward-facing belt path on the child restraint. Serious injury or death may result from poor installation. If you cannot tightly secure the child restraint, try again or move it to another location.

Tether Strap Warnings

Forward-facing and Booster Use Only

- To avoid a strangulation hazard, you **MUST** tightly roll or fold excess or unused tether strap and secure with a rubber band. Attach the tether hook to the storage clip when not in use (p. 14). This will keep an unused tether from hitting someone during a crash.

Additional Warnings

Rear-facing, Forward-facing, and Booster Use

- In hot or sunny weather, **ALWAYS** check the areas of the child restraint that may contact your child (e.g., buckle, buckle tongues, etc.) for hot areas before placing him/her into the child restraint. The child could be burned. Cover the child restraint with a light colored blanket when you leave the vehicle.
- This child restraint must be securely fastened to the vehicle, **even when unoccupied**, using the vehicle seat belts or Lower Anchor Connectors. An unsecured child restraint may injure someone if a crash occurs.
- **DO NOT** use the cup holders to store cans or hard cups. Only for use with soft cups (such as styrofoam or paper).
- **DO NOT** place any cups that contain hot liquids in the cup holders.
- **DO NOT** attach additional padding, toys, or other devices not made by Evenflo or described in these

⚠WARNING

Additional Warnings – continued

Rear-facing, Forward-facing, and Booster Use

- instructions for the child restraint. Items not tested with the child restraint could injure the child. Additional pads or pillows may interfere with the function of the harness system, or cause breathing problems if the child's head falls forward, increasing the risk of serious injury or death.
- Failure to follow installation instructions could result in serious injury or death. These instructions and the instructions in your vehicle owner's manual must be followed carefully. If there is a conflict between the two, the vehicle owner's manual regarding child restraint installation must be followed.
 - In cold weather, **DO NOT** dress the child in bulky clothing like snowsuits if the child is riding in a child restraint. Bulky coats/snowsuits make it difficult to properly tighten the harness to the child, which may allow the child to be ejected from the restraint during a crash. If necessary, place a blanket over the harnessed child without interfering with the child restraint harness system.

Safe Practices

- **Everyone rides buckled up or the vehicle does not go.** Make no exceptions for adults or children. If someone unbuckles, stop the vehicle. Being firm and consistent from the start will mean fewer discipline problems as children get older. An unrestrained person can be thrown into and injure other passengers.
- Many safety advocates and healthcare professionals recommend that children ride rear-facing for as long as possible. See limitations recommended on rear-facing use on the inside front cover.
- **NEVER** try to tend to a crying baby's needs while driving. **NEVER** take a baby out of a child restraint for comforting while the vehicle is moving.
- **DO NOT** allow a child in a vehicle to have objects such as lollipops or ice cream on a stick. The object can injure the child if the vehicle swerves or hits a bump.
- **DO NOT** feed an infant who is riding in a child restraint.
- Put sharp or heavy items in the trunk. Anything loose can be deadly in a crash.

Recall Information for U.S. Customers

- Child restraints could be recalled for safety reasons. You must register this restraint to be reached in a recall. Send your name, address, e-mail address if available, and the restraint's model number and manufacturing date to:

Evenflo Company, Inc.,
1801 Commerce Dr.,
Piqua, OH 45356
or call 1-800-233-5921.

or register on-line at:

www.evenflo.com/registercarseat

- For recall information, call the U.S. Government's Vehicle Safety Hotline at 1-888-327-4236 (TTY:1-800-424-9153), or go to: <http://www.NHTSA.gov>

Public Notice for Canadian Customers

- To register your child restraint, return your registration card, call 1-937-773-3971, or register online at www.evenflo.com/registercarseatcanada
- For recall information, call Transport Canada at 1-800-333-0510 (1-613-993-9851 in Ottawa region) or Evenflo at 1-937-773-3971.

Motor Vehicle/Aircraft Usage

When used with the 5-point harness system and properly installed pursuant to these instructions,

this restraint is certified for use only in passenger and multi-purpose passenger motor vehicles, buses, and trucks equipped with either lap belts only or lap/shoulder belt systems and in aircraft.

TIP!

Check with your airline before departure to make sure this restraint meets their requirements.

Refer to pages 62 to 66 for instructions on installing your child restraint in aircraft.

When used without the 5-point harness system (in booster mode) and properly installed pursuant to these instructions,

this restraint is certified for use only in passenger and multi-purpose passenger motor vehicles, buses, and trucks equipped with lap/shoulder belt systems only. In booster mode, this restraint is **NOT** certified for aircraft use. A belt-positioning booster requires the use of a lap/shoulder belt system, which is not available in aircraft.

Symbol Legend



Airbag Symbol – Alerts you to important information about airbag safety.



LATCH Symbol – Alerts you to important information about LATCH safety.



Tether Anchor Symbol – Alerts you to important information about Tether Anchor safety.



Aircraft Symbol – Alerts you to important information about aircraft safety.

Storing Your Instructions

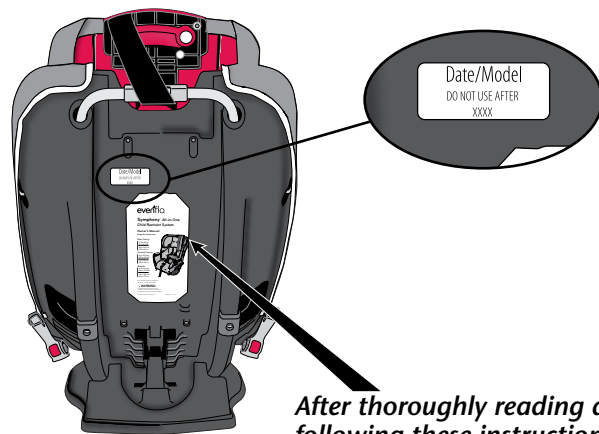

After thoroughly reading and following these instructions, store them in the slots provided on the back of the child restraint, as shown.

For future reference, record the **model number** of your child restraint **AND** the **date of manufacture** below.

Model Number: _____

Date of Manufacture: _____

Visual Glossary

Your vehicle components may be significantly different than pictured.
Consult your owner's manual to help you identify your vehicle components.

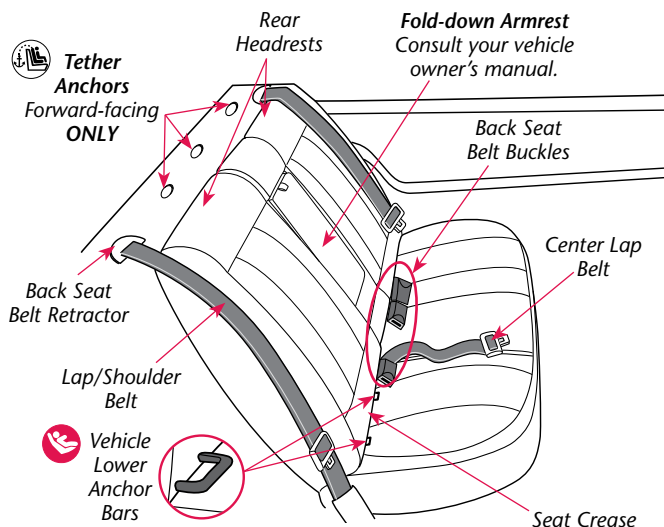

IMPORTANT: If your vehicle has **side air bags**, please refer to the warnings on page 2.

Visual Glossary

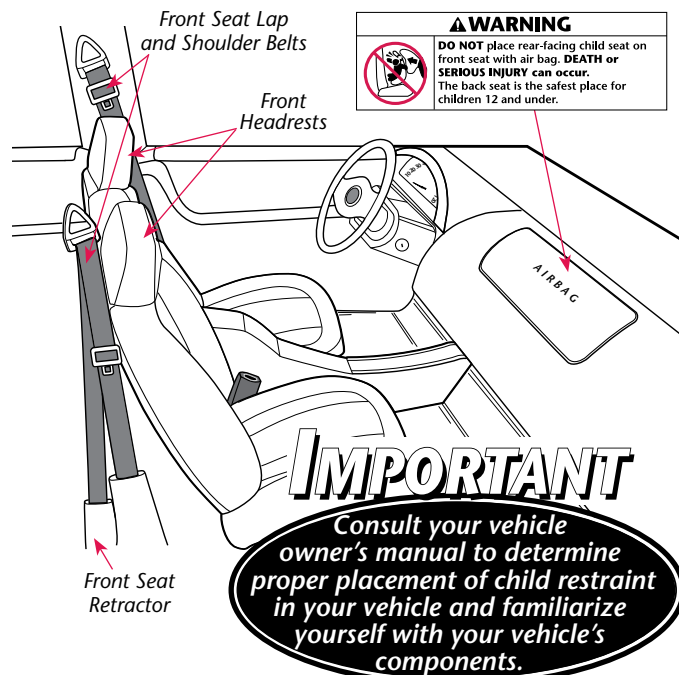

Important

Front

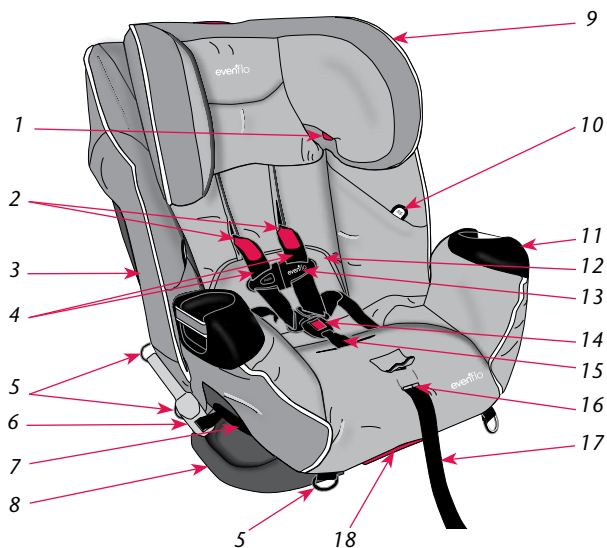

* Not all features are available on all models. Styles may vary.

Back

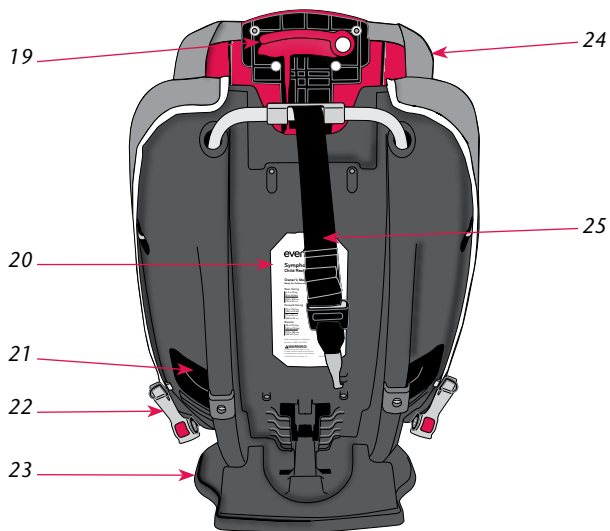

* Not all features are available on all models. Styles may vary.

Description

1. Shoulder Belt Guide
2. Harness Tabs
3. Seat Pad
4. Harness Straps
5. D-rings for SureLatch Connector
6. SureLatch Connector (Shown in rear-facing belt-path)
7. Rear-facing Belt Path
8. Base
9. Headrest*
10. Buckle Tongue Holder*
11. Cup Holder*
12. Access Flap
13. Chest Clip
14. Buckle
15. Crotch Strap
16. Harness Release Button (under flap)
17. Harness Adjust Strap
18. Recline Lever
19. Headrest Adjust Lever
20. Instructions
21. Forward-facing Belt Path
22. SureLatch Connector (Shown in rear-facing belt path)
23. Base
24. Headrest
25. Tether Strap and Hook (Shown fastened to storage clip)

Important

Securing the Child in the Child Restraint

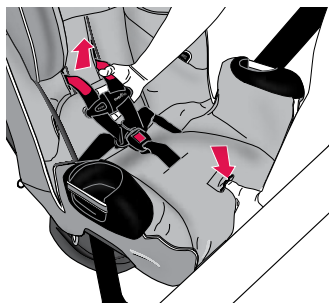

1. Loosen harness.

Press the harness release button on the front of the seat, then pull up on the harness strap behind the fastened chest clip.

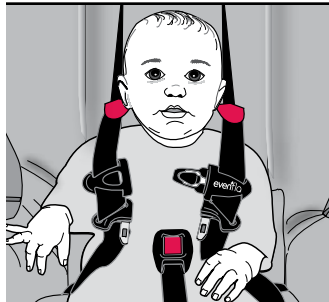

2. Position harness straps.

Unbuckle harness and unfasten chest clip (p. 18). Place the child in the child restraint. Bring each harness strap over each of the child's shoulders.

IMPORTANT: The baby's back and bottom should be flat against the restraint. If there is a gap, the baby will not be comfortable.

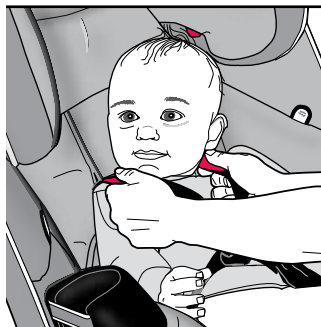

3. Adjust harness straps.

Grasping both red harness tabs, slide downward until the harness straps are at the child's shoulders.



4. Buckle the harness.

Insert both buckle tongues into the buckle. **Note:** Pull up on the harness straps to ensure that the buckle tongues are fastened securely.

Securing the Child in the Child Restraint

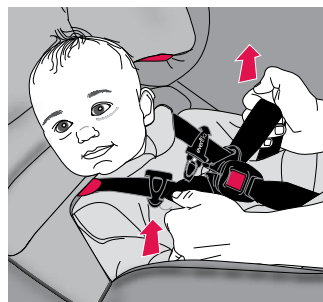

5. Remove all slack in harness.

Pull upward on the harness straps **near the hips**, as shown, to ensure that all slack is removed.

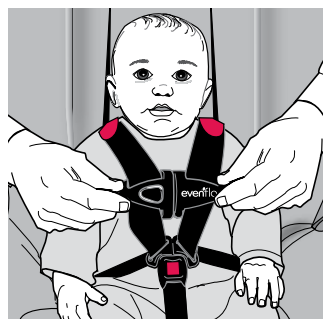

6. Fasten and adjust chest clip.

Snap the two halves of the chest clip together, as shown, and slide to armpit level.

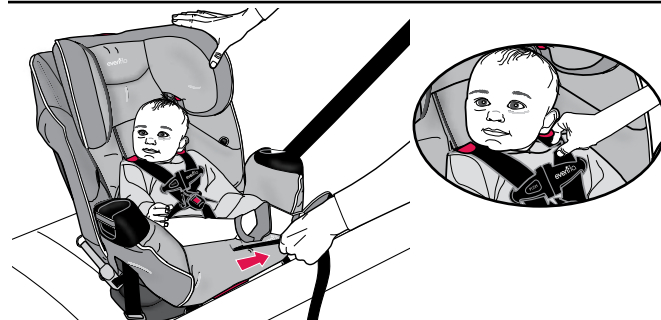

7. Tighten harness.

Pull the harness adjuster strap to tighten the harness. The harness straps must be snug against the child. A snug strap should not allow any slack. It lies in a relatively straight line without sagging. It does not press on the child's flesh or push the child's body into an unnatural position.

Note: Make sure the chest clip is at armpit level. Check the harness straps near the shoulders for slack. You should **NOT** be able to pinch the harness (see illustration). Adjust as needed.

Important

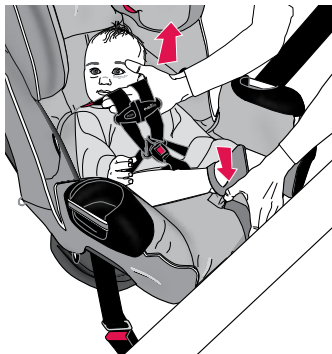

1. Loosen harness straps.

Press the harness release button on the front of the seat while pulling up on the harness strap behind the fastened chest clip.



2. Disconnect chest clip.

Push the release button and pull the chest clip apart.



3. Unbuckle harness.

Press the red button on the buckle and release both buckle tongues.

You may now remove your child.

Using Symphony™ in the Rear-facing Position

Child Requirements

Weight: 2.3 to 18 kg (5 to 40 lbs)

Height: 48 to 102 cm (19 to 40 inches) **AND** the top of child's head is at least 25 mm (1 inch) below the top of the child restraint headrest in either of its two lowest positions.

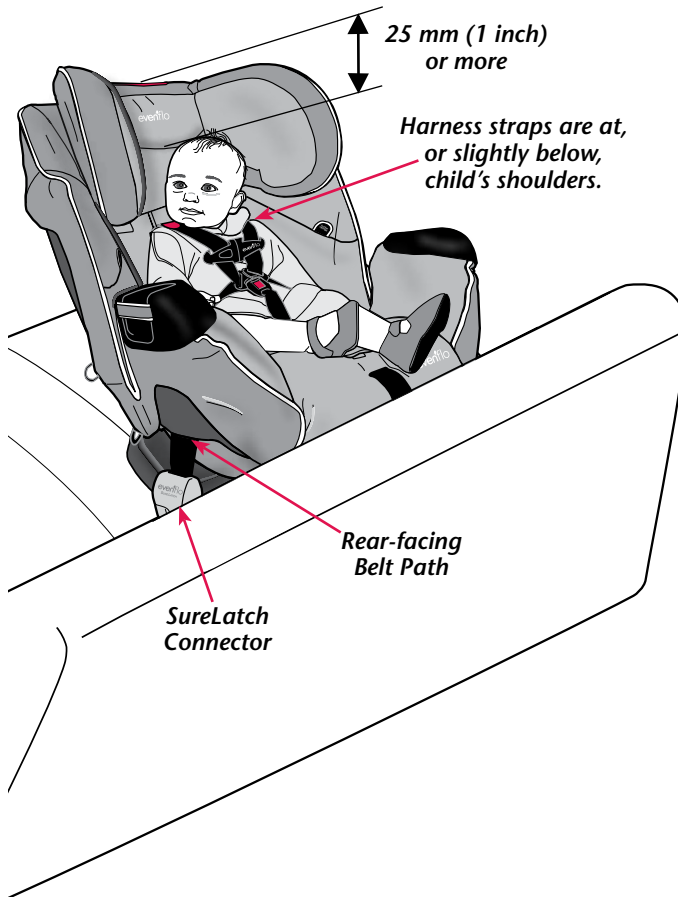

Rear-facing Installation Checklist

1. Secure child restraint to the vehicle seat.

- ✓ Restraint is securely locked in **Recline Position #1** (p. 58).
- ✓ Locking clip is installed, if necessary (p. 30).
- ✓ The level line is level with ground (p. 26/31).
A towel/small blanket is rolled up and placed beneath the front edge of the base, if necessary.
- ✓ Child restraint is securely installed with one of the following methods using the **rear-facing belt path**:
 - SureLatch Connectors (p. 22)
 - Quick Connectors (p. 22)
 - Vehicle Seat Belts (p. 28)

Note: To determine which type of Lower Anchor Connector is on your child restraint, go to page 22.

2. Place the child in the child restraint.

- ✓ The child's back and bottom are flat against the back and bottom surfaces of the child restraint.
- ✓ Top of child's head is at least 25 mm (1 inch) below the top of the child restraint headrest in either of its two lowest positions.

3. Make necessary adjustments.

- ✓ Red harness tabs **MUST** be at, or slightly below, shoulder level (p. 16).
- ✓ Headrest is adjusted to either of the bottom two positions closest to the harness tabs (p. 58).

4. Fasten both buckle tongues. Refer to page 16.

5. Position and connect chest clip.

- ✓ Chest clip **MUST** be placed at armpit level (p. 17).

6. Check your work.

- ✓ Harness straps are snug against the child's shoulders, with no slack (p. 17).
- ✓ To properly secure this child restraint, it **MUST NOT** move more than 25 mm (1 inch) from **side to side** or **front to back** at the rear-facing belt path.

TIP! To make installation easier, watch the installation video of this child restraint at www.evenflo.com.

Which Type of Lower Anchor Connector Is on Your Child Restraint?

Your child restraint will have one of the two types of Lower Anchor Connectors shown below. Follow the instructions on the following pages to properly install the Lower Anchor Connector Assembly on your child restraint.

SureLatch Connector

Not available on all models.

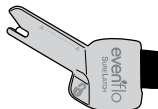

Quick Connector

Not available on all models.

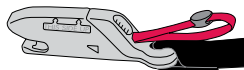

Moving Lower Anchor Connector Assembly to Rear-facing Belt Path

To install this child restraint properly in the rear-facing position, the Lower Anchor Connector Assembly **MUST** be in the **rear-facing belt path**, as shown on the next page (seat pad has been removed for clarity). If the Lower Anchor Connector Assembly is in the forward-facing belt path (shown on next page), use the following procedures to move it to the **rear-facing belt path**.

To access the Lower Anchor Connector Assembly, you will first need to:

- Loosen internal harness straps (p. 16);
- Disconnect SureLatch Lower Anchor Connectors or Quick Connector Lower Anchor Connectors (p. 56);
- Remove the seat pad (p. 59).

Moving Lower Anchor Connector Assembly to Rear-facing Belt Path

SureLatch

Lower Anchor Connector Assembly in Rear-facing Belt Path

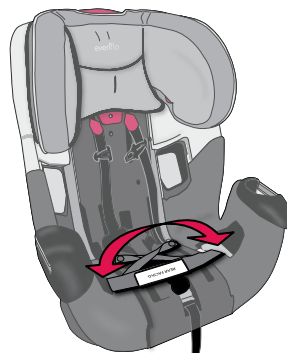

Lower Anchor Connector Assembly in Forward-facing Belt Path

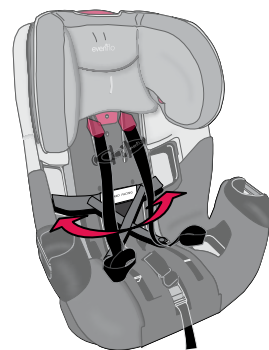

Rear-facing

Quick Connector

Lower Anchor Connector Assembly in Rear-facing Belt Path

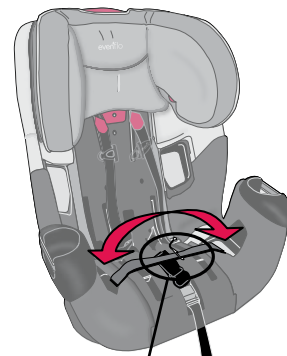

Lower Anchor Connector Assembly in Forward-facing Belt Path

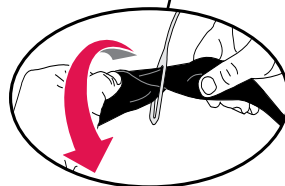
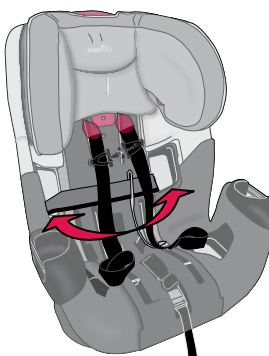

Note: After moving the Lower Anchor Connector Assembly, make sure the strap lays flat against the seat shell. You may have to twist the strap to achieve this.

Moving Lower Anchor Connector Assembly to Rear-facing Belt Path

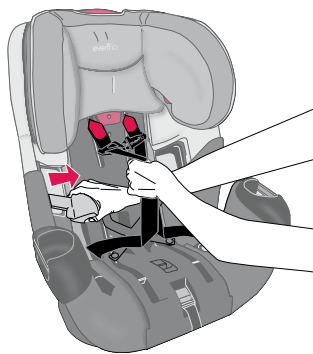

1. Remove Lower Anchor Connectors from the forward-facing belt path.

Reach through the harness straps and remove each Lower Anchor Connector, one at a time.

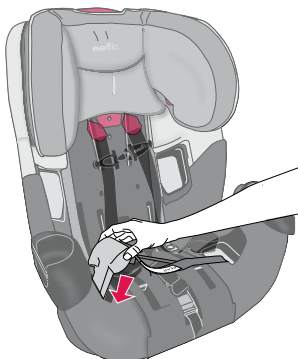

2. Place each Lower Anchor Connector in the rear-facing belt path.

IMPORTANT: Make sure the Lower Anchor Connector Assembly does not interfere with the internal harness straps.

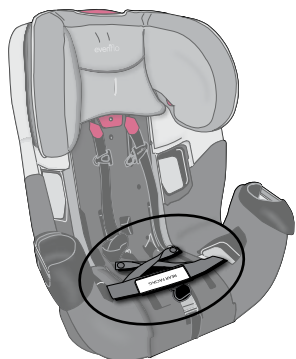

3. Make sure the crotch buckle assembly is positioned in front of the Lower Anchor Connector Assembly, as shown.



Note: Do not forget to install the seat pad before installing the child restraint in your vehicle.

Rear-facing Installation with Lower Anchor Connectors

IMPORTANT:

- If you are using the vehicle seat belt to secure the child restraint, **DO NOT** use Lower Anchor Connectors.
- **DO NOT** use the tether strap when the child restraint is in the rear-facing position.

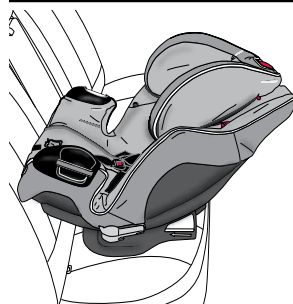

1. Place the child restraint in position.

Adjust the child restraint to the **most** reclined position (*Recline Position #1*, p. 58), then place it on the vehicle seat in the rear-facing position, as shown.

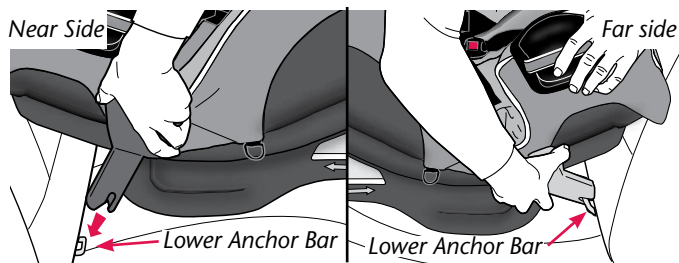

2. Attach Lower Anchor Connectors.

Push a Lower Anchor Connector onto **each** vehicle Lower Anchor Bar.

Note: You may need to vary the angle of the Lower Anchor Connectors, as shown above, to attach to the Lower Anchor Bars. Also, make sure the Lower Anchor Connector Assembly is in the rear-facing belt path (p. 23).

IMPORTANT: Make sure both SureLatch Connectors or Quick Connectors are facing upward and the straps are not twisted.

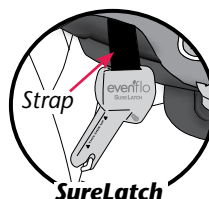

Correct

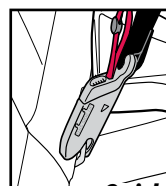

Incorrect

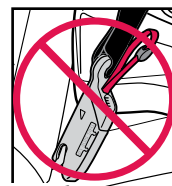

Quick Connector

Rear-facing Installation with Lower Anchor Connectors

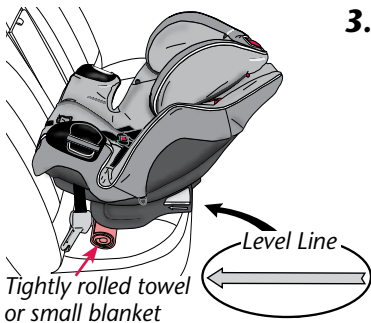

3. Increase recline angle, if necessary. If level line is not parallel to the ground, disconnect Lower Anchor Connectors and place a tightly rolled towel/small blanket beneath the front edge of the child restraint. **Repeat Step 2.**

IMPORTANT: Infants may have difficulty breathing when in a sitting position. Make sure they recline enough for their head to lie back comfortably and safely. Failure to properly recline the child restraint could increase the child's risk of serious injury or death.

4. Ensure child restraint is secure.

To secure a child restraint that has SureLatch connectors, go to Step 4a. To secure a child restraint that has Quick Connectors, go to Step 4b.

Rear-facing Installation with Lower Anchor Connectors

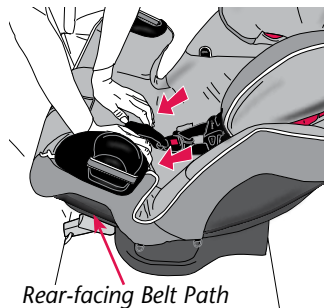

4a. Secure the child restraint – SureLatch Connector.

Using your full weight, push the child restraint firmly into the vehicle seat, as shown, to lock in place.

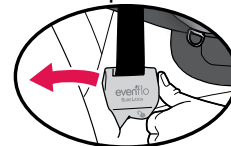

Note: In some vehicles, you may need to prop up the SureLatch Connector *while* pushing downward on the seat to secure it tightly. Repeat for the other SureLatch Connector.

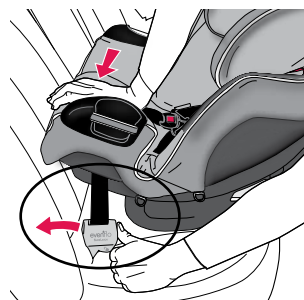

IMPORTANT: To properly secure this child restraint, it **MUST NOT** move more than 25 mm (1 inch) from side to side or front to back **at the rear-facing belt path**. If you cannot tightly secure the child restraint, try again or move it to another location.

4b. Secure the child restraint – Quick Connector.

Using your full weight, push the child restraint firmly into the vehicle seat while pulling up on the Lower Anchor Strap to tighten, as shown.

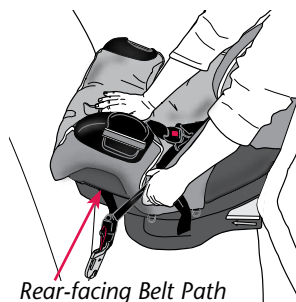

IMPORTANT: To properly secure this child restraint, it **MUST NOT** move more than 25 mm (1 inch) from side to side or front to back **at the rear-facing belt path**. If you cannot tightly secure the child restraint, try again or move it to another location.

Rear-facing Installation with Seat Belt

IMPORTANT:

- If you are using Lower Anchor Connectors to secure the child restraint, **DO NOT** use the vehicle seat belt.
- Before installing this child restraint rear-facing with the vehicle seat belt, you **MUST** move the Lower Anchor Connector Assembly to the forward-facing belt path so that it does not interfere with the vehicle seat belt. Refer to pages 34 to 36 for instructions on moving the SureLatch Connectors or Quick Connectors to the forward-facing belt path.
- Make sure the SureLatch Connectors or Quick Connectors are attached to the storage D-rings on the seat pad.
- Check your vehicle owner's manual to determine how to lock your seat belt for child restraint installation. The seat belt must be locked to properly secure the child restraint.
- **DO NOT** use the Tether Strap when the child restraint is in the rear-facing position.

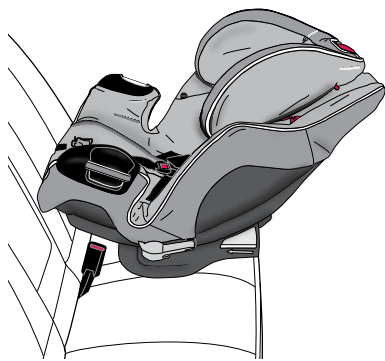

1. Place the child restraint in position.

Adjust the child restraint to the **most** reclined position (*Recline Position #1*, p. 58), then place it on vehicle seat in the rear-facing position, as shown.

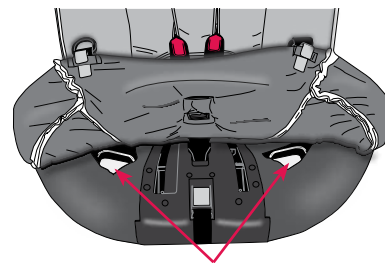

Rear-facing Belt Path

2. Route seat belt through rear-facing belt path.

Unhook the front of the seat pad and move it out of the way, as shown.

Thread the vehicle seat belt buckle through the rear-facing belt path, as shown on the next page.

Rear-facing Installation with Seat Belt

Lap Belt Only

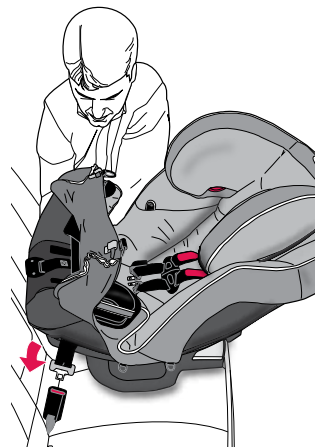

Lap and Shoulder Belt Combination

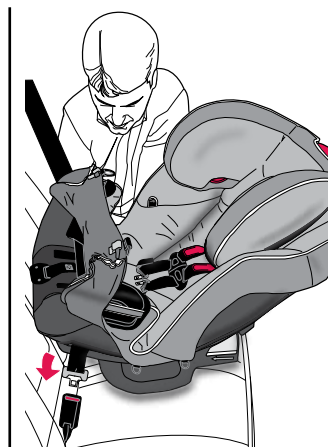

IMPORTANT: Make sure the buckle/crotch strap is positioned **in front of** the vehicle seat belt.

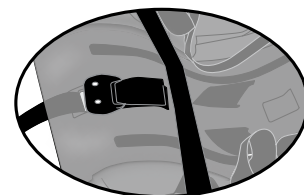

3. Buckle seat belt, then remove all slack from the seat belt.

Using your full weight, push the child restraint firmly onto the vehicle seat while tightening the vehicle seat belt to remove excess slack.

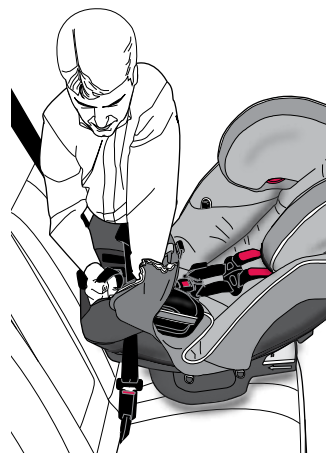

Rear-facing Installation with Seat Belt

4. Install Locking Clip (not included), if necessary.

If your vehicle was built **prior to model year 1996**, and has a lap/shoulder belt that is equipped with an emergency locking retractor (ELR) AND sliding latch plate, you **MUST** use a Locking Clip. Check your vehicle owner's manual to identify which vehicle belt system is in your vehicle.

Locking Clip installed properly.

13 mm
(0.5 inch)

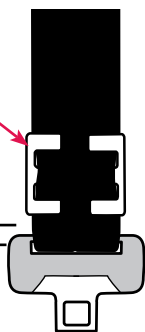

If your vehicle is **model year 1996 or newer**, it likely has a vehicle belt system that can be locked when tightened, and will not require use of a Locking Clip.

Consult your vehicle owner's manual before installing a Locking Clip.

If your vehicle requires a Locking Clip, please call ParentLink at 1-800-233-5921 (U.S.) or 1-937-773-3971 (Canada), or 01-800-706-12-00 (Mexico) to obtain a Locking Clip and instructions on how to install and use it.

⚠ WARNING

- Remove Locking Clip from vehicle seat belt when not used with a child restraint, or the vehicle seat belt will not properly restrain an adult or child. Serious injury could occur.

- DO NOT** use a Locking Clip in booster mode.

Rear-facing Installation with Seat Belt

5. Increase recline angle, if necessary.

If the level line is not parallel to the ground, disconnect the seat belt and place a tightly rolled towel/small blanket beneath the front edge of the child restraint.

Repeat Step 2.

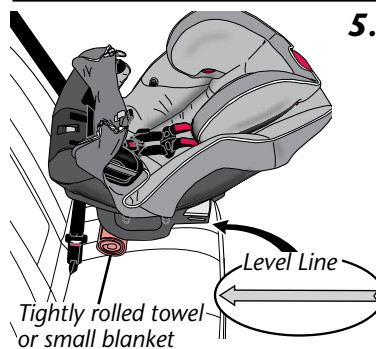

IMPORTANT: Infants may have difficulty breathing when in a sitting position. Make sure they recline enough for their head to lie back comfortably and safely. Failure to properly recline the child restraint could increase the child's risk of serious injury or death.

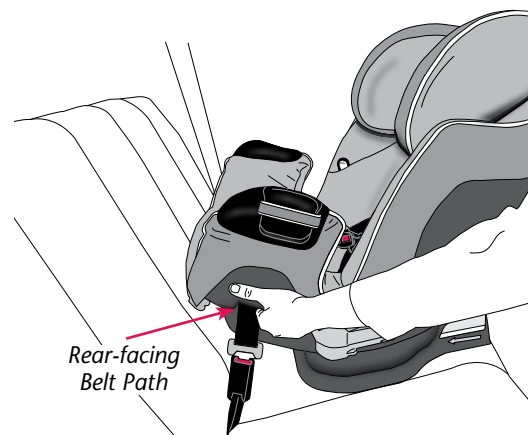

6. Ensure child restraint is secure.

Reconnect the seat pad to the front of the restraint. With your hand holding the seat shell at the rear-facing belt path, as shown, try to move the child restraint from side to side. Then, holding the seat shell at each rear-facing belt path, try to move the restraint from front to back.

For the child restraint to be properly secured, it **MUST NOT** move more than 25 mm (1 inch) from side to side or front to back **at the belt path**. If you cannot tightly secure the child restraint, try again or move it to another location.

Using Symphony™ in the Forward-facing Position

Child Requirements

Weight: 10 to 29.4 kg (22 to 65 lbs)

Height: 71 to 127 cm (28 to 50 inches)

AND the tops of the child's ears are below the top of the child restraint headrest.

Age: At least one year old

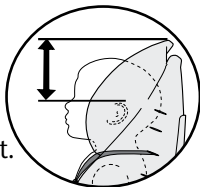

IMPORTANT

When installing this child restraint with Lower Anchor Connectors or the vehicle seat belt, always use the top anchorage (Tether) strap, if a Tether Anchor is available.

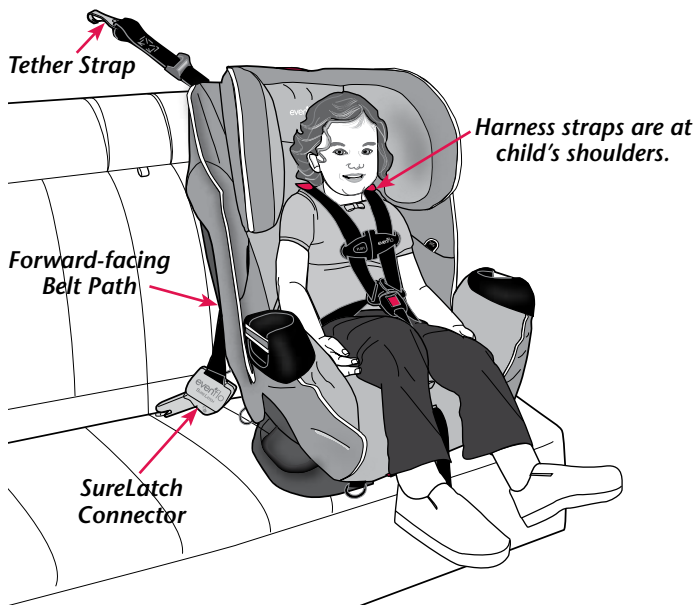

⚠ WARNING

If the child weighs more than 29.4 kg (65 lbs) **OR** their shoulders are above the highest harness level, you **MUST** use this child restraint as a booster seat.

Forward-facing Installation Checklist

1. Secure child restraint to the vehicle seat.

- ✓ Restraint is securely locked into **Recline Position #2 or #3** (p. 58).
- ✓ Locking clip is installed, if necessary (p. 44).
- ✓ **If the child weighs 20.4 kg (45 lbs) or less**, the child restraint is securely installed with one of the following methods through the **forward-facing belt path**:
 - SureLatch Connectors (p. 34)
 - Quick Connectors (p. 34)
 - Vehicle seat belts (p. 42)

Note: To determine which type of Lower Anchor Connector is on your child restraint, go to page 34.

- ✓ **If the child weighs more than 20.4 kg (45 lbs)**, the child restraint is securely installed with the vehicle seat belt (not the Lower Anchor Connectors) through the **forward-facing belt path** (p. 42).

- ✓ Tether Strap is attached and tightened (p. 41 or 46).

2. Place the child in the child restraint.

- ✓ The child's back and bottom are flat against the back and bottom surfaces of the child restraint.
- ✓ The tops of the child's ears **MUST** be below the top of the child restraint headrest.

3. Make necessary adjustments.

- ✓ Red harness tabs **MUST** be at shoulder level (p. 16).
- ✓ Headrest is adjusted so that its bottom is nearest to the red harness tabs (p. 58).

4. Fasten both buckle tongues. Refer to page 16.

5. Position and connect chest clip.

- ✓ Chest clip **MUST** be at armpit level (p. 17).

6. Check your work.

- ✓ Harness straps are snug against the child's shoulders, with no slack (p. 17).
- ✓ To properly secure this child restraint, it **MUST NOT** move more than 25 mm (1 inch) from **side to side** or **front to back** at the forward-facing belt path.

TIP! To make installation easier, watch the installation video of this child restraint at www.evenflo.com.

Which Type of Lower Anchor Connector Is on Your Child Restraint?

Your child restraint will have one of the two types of Lower Anchor Connectors shown below. Follow the instructions on the following pages to properly install the Lower Anchor Connector Assembly on your child restraint.

SureLatch Connector

Not available on all models.

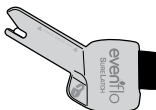

Quick Connector

Not available on all models.

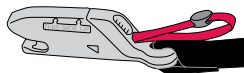

Moving Lower Anchor Connector Assembly to Forward-facing Belt Path

To install this child restraint properly in the forward-facing position, the Lower Anchor Connector Assembly **MUST** be in the **forward-facing belt path**, as shown on the next page (seat pad has been removed for clarity). If the Lower Anchor Connector Assembly is in the rear-facing belt path (shown on the next page), use the following procedures to move it to the **forward-facing belt path**.

To access the Lower Anchor Connector Assembly, you will first need to:

- Loosen internal harness straps (p. 16);
- Disconnect SureLatch Lower Anchor Connectors or Quick Connector Lower Anchor Connectors (p. 56);
- Remove seat pad (p. 59).

Moving Lower Anchor Connector Assembly to Forward-facing Belt Path

SureLatch

Lower Anchor Connector Assembly in Forward-facing Belt Path

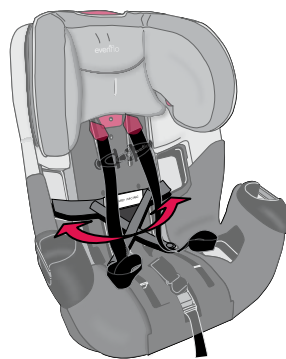

Lower Anchor Connector Assembly in Rear-facing Belt Path

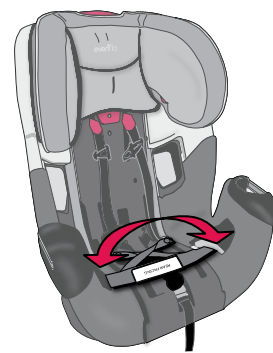

Quick Connector

Lower Anchor Connector Assembly in Forward-facing Belt Path

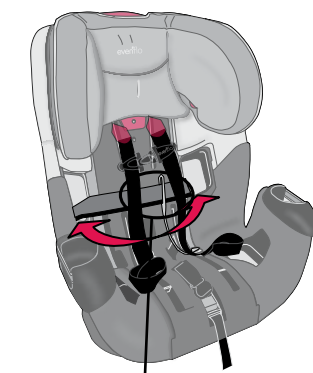

Lower Anchor Connector Assembly in Rear-facing Belt Path

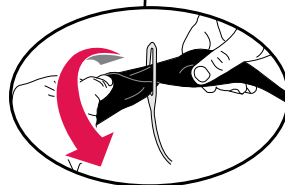
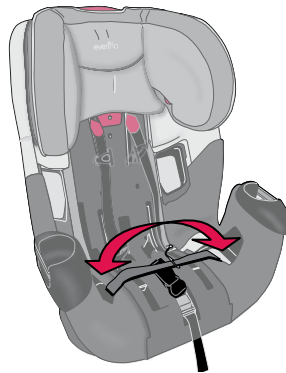

Note: After moving the Lower Anchor Connector Assembly, make sure the strap lays flat against the seat shell. You may have to twist the strap to achieve this.

Forward-facing

Moving Lower Anchor Connector Assembly to Forward-facing Belt Path

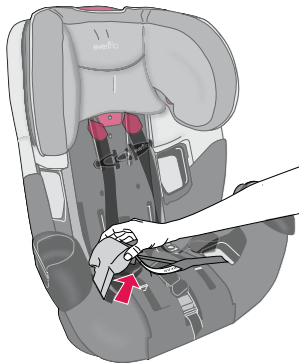

1. Remove Lower Anchor Connectors from the rear-facing belt path.

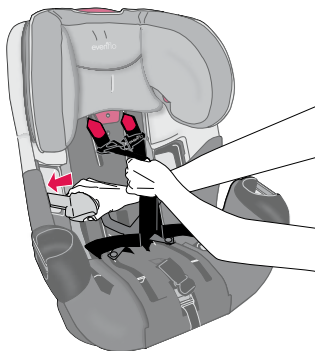

2. Place each Lower Anchor Connector in the forward-facing belt path. Pull the harness strap out of the way and insert a Lower Anchor Connector, **behind** the straps, into the forward-facing belt path opening, as shown. Repeat on the other side.

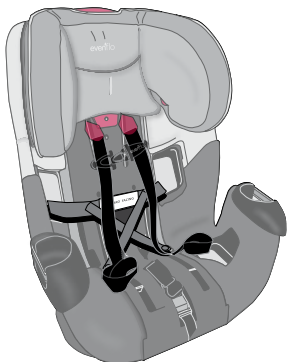

IMPORTANT: Make sure the Lower Anchor Connector Assembly does not interfere with the internal harness straps.

Note: Do not forget to install the seat pad before installing the child restraint in your vehicle.

Forward-facing Installation with Lower Anchor Connectors

LATCH is a system for attaching the child restraint to your vehicle seat. It is to be used in place of your vehicle's seat belts and can be used in vehicles with LATCH anchors. Your vehicle owner's manual may refer to this system as ISOFIX, Universal Anchorage System (UAS), or Lower Universal Anchorage System.

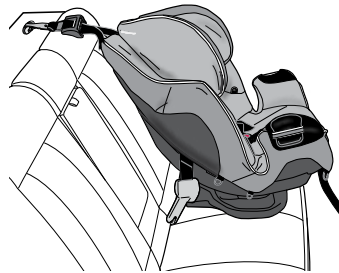

DO NOT install by this method for a child weighing more than 20.4 kg (45 lbs).

WARNING

- **ONLY** use for securing child restraint to vehicle Lower Anchor Bars.
- **ALWAYS** read and follow exactly the instructions which accompany your vehicle and child restraint.
- **NEVER** attach two Lower Anchor Connectors to one vehicle Lower Anchor Bar.
- **DO NOT** use the vehicle seat belts to install a child restraint when using the Lower Anchor Connector Assembly.
- This Lower Anchor Connector Assembly is intended to be used **ONLY** as described in these instructions. Serious injury or death may result from misuse.
- **ALWAYS** be sure that the Lower Anchor Connectors are attached to the vehicle Lower Anchor Bars by pulling hard on the Lower Anchor Connectors. If they are not attached, the Lower Anchor Connector Assembly will not secure your child restraint. Serious injury or death may result.
- To avoid a strangulation hazard, you **MUST** store the unused Lower Anchor Connector Assembly, with all slack removed, in storage area on the seat (p. 56). Roll or fold excess Lower Anchor Connector Strap and secure with a rubber band to prevent serious injury to vehicle occupants.
- In addition to these instructions, read and follow your vehicle owner's manual regarding installation of child restraints and LATCH. If there is a discrepancy, follow your vehicle owner's manual.

Forward-facing Installation with Lower Anchor Connectors

IMPORTANT:

- If you are using the vehicle seat belt to secure the child restraint, **DO NOT** use Lower Anchor Connectors.
- **DO NOT** use the Lower Anchors of the child restraint anchorage system (LATCH system) to attach this child restraint when restraining a child weighing more than 20.4 kg (45 lbs) with the internal harnesses of the child restraint.
- Install this child restraint with the vehicle seat belt (**NOT** Lower Anchor Connectors) if the child weighs more than 20.4 kg (45 lbs).
- Some vehicle manufacturers have lower maximum weight ratings for vehicle Lower Anchor Bars. Consult your vehicle owner's manual, or call the vehicle manufacturer, to confirm the limits on your vehicle's Lower Anchor Bars.

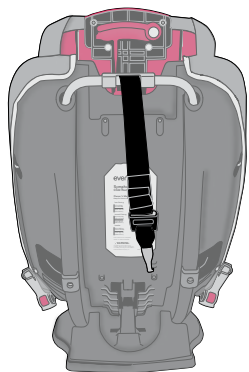

1. Disconnect the tether hook from the back of the child restraint.

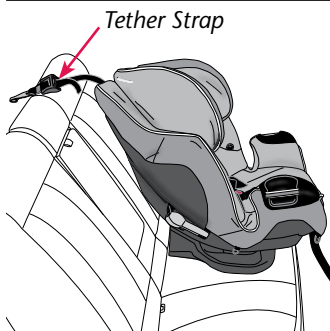

2. Place the child restraint in position.

Make sure child restraint is in **Recline Position #2 or #3** (p. 58). Set child restraint on vehicle seat in the **forward-facing** position, as shown. Lay the tether strap over the back of the vehicle seat.

IMPORTANT: NEVER use Recline Position #1 for forward facing, AND **NEVER** use Recline Position #2 with children who weigh more than 18 kg (40 lbs).

Forward-facing Installation with Lower Anchor Connectors

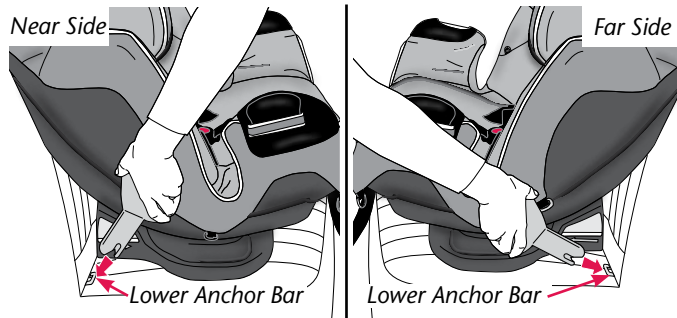

3. Attach Lower Anchor Connectors.

Push a Lower Anchor Connector onto **each** vehicle Lower Anchor Bar.

Note: You may need to vary the angle of the Lower Anchor Connectors, as shown above, to attach to the Lower Anchor Bars. Also, make sure the Lower Anchor Connector Assembly is in the forward-facing belt path (p. 35).

IMPORTANT: Make sure both SureLatch Connectors or Quick Connectors are facing upward and the straps are not twisted.

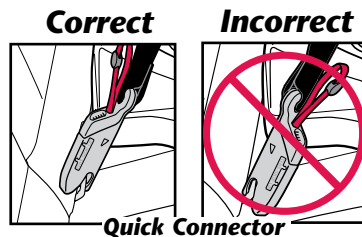
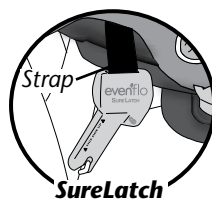

4. Ensure child restraint is secure.

To secure a child restraint that has SureLatch Connectors, go to Step 4a. To secure a child restraint that has Quick Connectors, go to Step 4b.

Forward-facing Installation with Lower Anchor Connectors

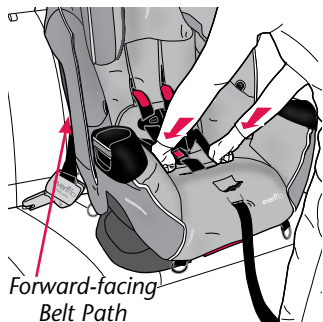

4a. Secure the child restraint – SureLatch Connector.

Using your full weight, push the child restraint firmly into the vehicle seat, as shown, to set it in place.

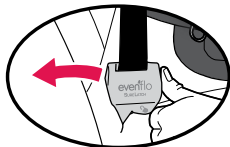

Note: In some vehicles, you may need to prop up the SureLatch Connector while pushing downward on the seat to secure it tightly. Repeat for the other SureLatch Connector.

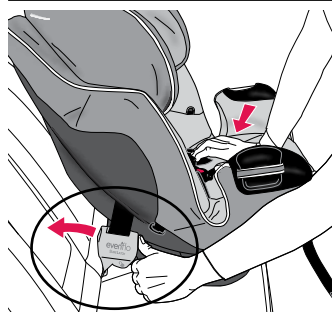

IMPORTANT: To properly secure this child restraint, it **MUST NOT** move more than 25 mm (1 inch) from side to side or front to back **at the forward-facing belt path.** If you cannot tightly secure the child restraint, try again or move it to another location.

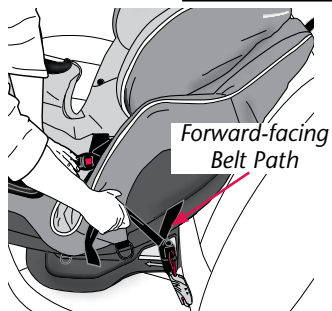

4b. Secure the child restraint – Quick Connector.

Using your full weight, push the child restraint firmly into the vehicle seat while pulling up on the Lower Anchor Strap to tighten, as shown.

IMPORTANT: To properly secure this child restraint, it **MUST NOT** move more than 25 mm (1 inch) from side to side or front to back **at the forward-facing belt path.** If you cannot tightly secure the child restraint, try again or move it to another location.

Forward-facing Installation with Lower Anchor Connectors

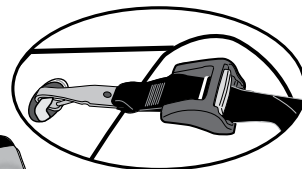
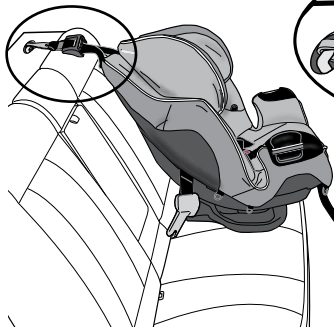

5. Connect and tighten tether strap.

Connect the Tether Hook to the vehicle Tether Anchor behind the vehicle seat, as shown.

(Please consult your vehicle owner's manual, as Tether Anchor locations may vary.) Pull the strap and tighten the Tether securely.

IMPORTANT:

- The Tether Strap **MUST** be used when installing this child restraint forward-facing with the Lower Anchor Connector Assembly.
- If your Tether Strap is too short to reach from your child restraint to your vehicle Tether Anchor, you will need a Tether Extender. Please call ParentLink at 1-800-233-5921 (U.S.) or 1-937-773-3971 (Canada), or 01-800-706-12-00 (Mexico).

Forward-facing Installation with Seat Belt

IMPORTANT:

- If you are using Lower Anchor Connectors to secure the child restraint, **DO NOT** use the vehicle seat belt.
- Before installing this child restraint forward-facing with the vehicle seat belt, you **MUST** move the Lower Anchor Connector Assembly to the rear-facing belt path so that it does not interfere with the vehicle seat belt. Refer to pages 22 to 24 for instructions on moving the SureLatch Connectors or Quick Connectors to the rear-facing belt path.
- Make sure the SureLatch or Quick Connectors are attached to the storage D-rings on the seat pad.
- Check your vehicle owner's manual to determine how to lock your seat belt for child restraint installation. The seat belt must be locked to properly secure the child restraint.

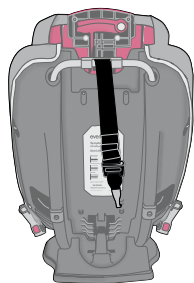

- 1. Disconnect tether hook from the back of the child restraint.**

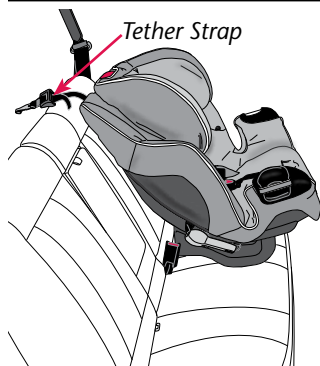

- 2. Place the child restraint in position.** Make sure child restraint is in *Recline Position #2* or *#3* (p. 58). Set child restraint on the vehicle seat in the **forward-facing** position, as shown. Lay the tether strap over the back of the vehicle seat.

IMPORTANT: NEVER use *Recline Position #1* for forward-facing, **AND NEVER** use *Recline Position #2* with children who weigh more than 18 kg (40 lbs).

Forward-facing Installation with Seat Belt

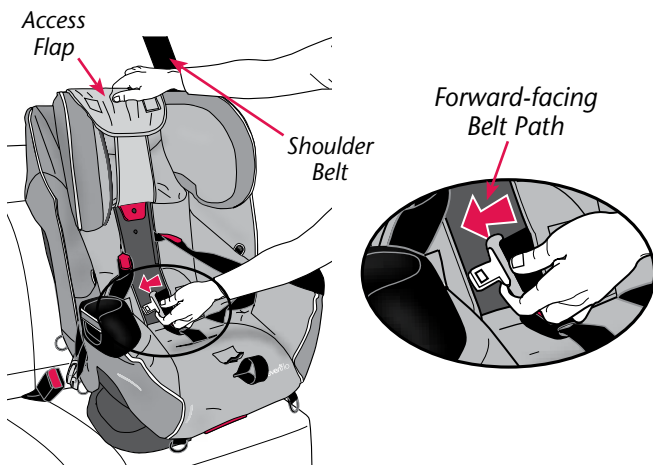

- 3. Route seat belt through forward-facing belt path.**

Move the harness out of the way and raise the access flap. Route the seat belt buckle through the forward-facing belt path, as shown.



- 4. Buckle seat belt, then remove all slack from the seat belt.**

Using your full weight, push the child restraint firmly into the vehicle seat while tightening seat belt to remove excess slack.

Forward-facing Installation with Seat Belt

5. Install Locking Clip (not included), if necessary.

If your vehicle was built **prior to model year 1996**, and has a lap/shoulder belt that is equipped with an emergency locking retractor (ELR) AND sliding latch plate, you **MUST** use a Locking Clip. Check your vehicle owner's manual to identify which vehicle belt system is in your vehicle.

If your vehicle is **model year 1996 or newer**, it likely has a vehicle belt system that can be locked when tightened, and will not require use of a Locking Clip.

Consult your vehicle owner's manual before installing a locking clip.

If your vehicle requires a Locking Clip, please call ParentLink at 1-800-233-5921 (U.S.) or 1-937-773-3971 (Canada), or 01-800-706-12-00 (Mexico) to obtain a Locking Clip and instructions on how to install and use it.

⚠ WARNING

- Remove Locking Clip from vehicle seat belt when not used with a child restraint, or the vehicle seat belt will not properly restrain an adult or child. Serious injury could occur.
- **DO NOT** use a Locking Clip in booster mode.

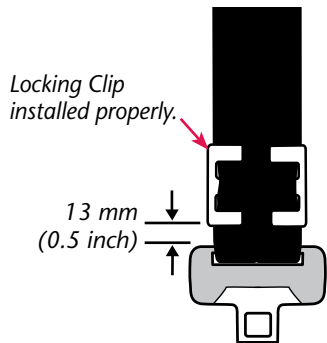

Forward-facing Installation with Seat Belt

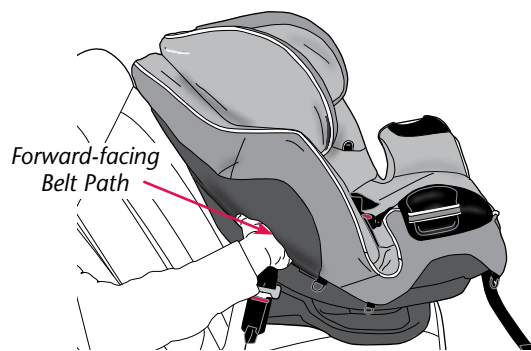

6. Ensure child restraint is secure.

With your hand holding the seat shell at the forward-facing belt path, as shown, try to move the child restraint from side to side. Then, holding the seat shell at each forward-facing belt path, try to move the restraint from front to back.

For the child restraint to be properly secured, it **MUST NOT** move more than 25 mm (1 inch) from side to side or front to back **at the belt path**. If you cannot tightly secure the child restraint, try again or move it to another location.

Forward-facing

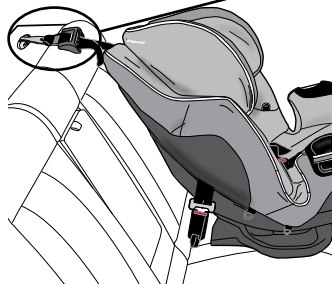
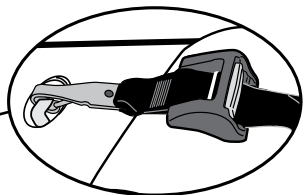

7. Connect and tighten Tether Strap.

Connect the Tether Hook to the vehicle Tether Anchor behind the vehicle seat, as shown.

(Please consult your vehicle owner's manual, as Tether Anchor locations may vary.) Pull the strap and tighten the Tether securely.

IMPORTANT:

- The Tether Strap **MUST** be used when installing this child restraint forward-facing with the vehicle seat belt, if a Tether Anchor is available.
- If your Tether Strap is too short to reach from your child restraint to your vehicle Tether Anchor, you will need a Tether Extender. Please call ParentLink at 1-800-233-5921 (U.S.) or 1-937-773-3971 (Canada), or 01-800-706-12-00 (Mexico).

This page is intentionally blank.

When to Put Your Child in a Booster Seat

Booster seats raise the child up and help to position the vehicle lap and shoulder belt correctly. When the child is properly restrained in a booster seat, his/her risk of injury in all types of crashes is reduced, as the lap and shoulder belt provides excellent restraint of both the upper and lower torsos.

It is important for the child to sit properly within the vehicle seat belts. When the vehicle belt is buckled, the lap belt should be low on the hips, just touching the thighs, and the shoulder belt should lie across the middle of the shoulder. If the child leans out or moves the belt behind the back or places it under the arm, it **will not provide the intended restraint.**

There are a number of things to consider when deciding whether a child is ready to sit in a booster seat, including: the weight and height ratings on his/her current child seat, the child's own weight and height, his/her maturity, and the seating positions available in your vehicle.

How is a booster seat used?

Using a booster seat is very similar to buckling yourself into the vehicle:

- Read the instruction manuals for both the booster seat and the vehicle before you start.
- Put the booster in the back seat in a location with a lap and shoulder belt. **Never use a booster with only a lap belt**, as this could cause serious injuries.
- After the child is in the booster, pull the lap and shoulder belt across him/her and buckle it.
- Check that the shoulder belt lies across the middle of the shoulder and that the lap belt is low on the hips, just touching the thighs.

How can you tell if a child is ready to transition to a booster seat?

You should consider using a booster seat if the following conditions apply:

- The child is mature enough to sit in the booster seat and not put the belts under his/her arm or behind his/her back.
- The child is approaching the weight or height limit of the child restraint he/she is currently using. (Even children who have not outgrown their toddler seat can benefit from the use of a booster seat, if it is used properly.)
- If you have a vehicle that does not have a Tether Anchorage but has lap/shoulder belts available in the back seat, a booster seat may provide better protection than an internal harness seat without the Tether.

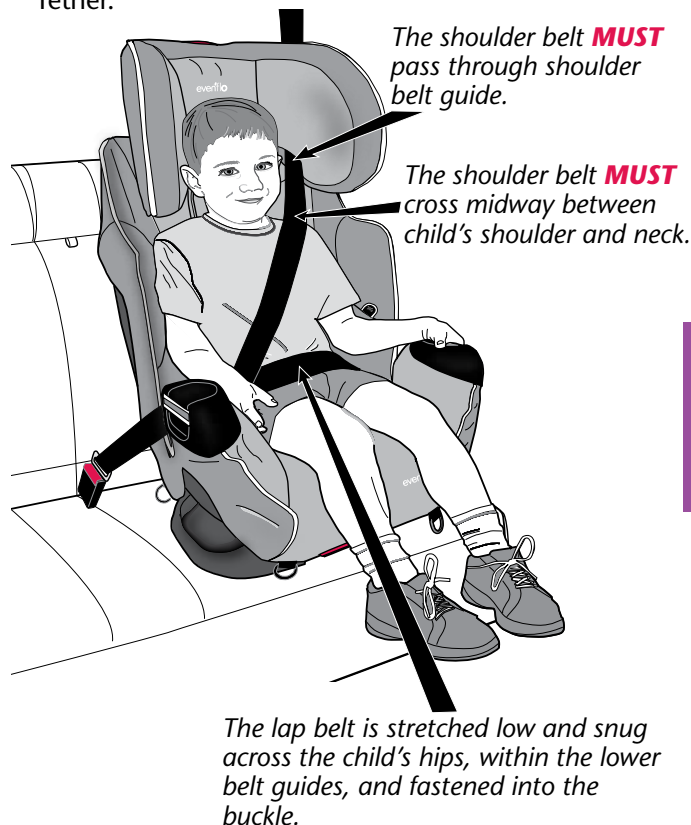

Using Symphony™ as a Booster Seat

Child Requirements

Weight: 18 to 49.8 kg (40 to 110 lbs)

Height: 112 to 145 cm (44 to 57 inches)

AND the tops of the child's ears are below the top of the child restraint headrest.

Age: At least four years old

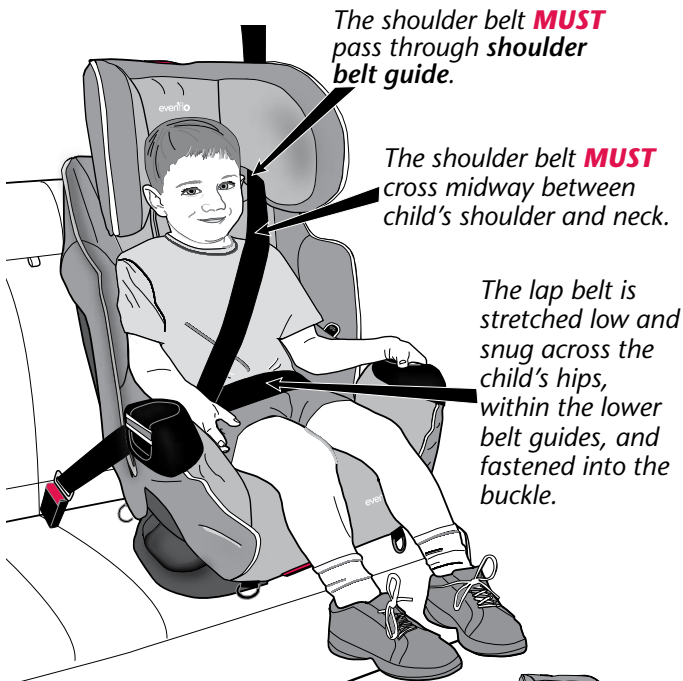
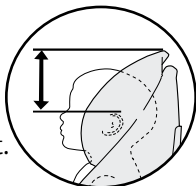

The shoulder belt **MUST** pass through shoulder belt guide.

The shoulder belt **MUST** cross midway between child's shoulder and neck.

The lap belt is stretched low and snug across the child's hips, within the lower belt guides, and fastened into the buckle.



IMPORTANT

Always secure the booster seat with the Lower Anchor Connectors or vehicle seat belt when not occupied. An unsecured booster seat can fly into and injure other occupants in the event of a crash.

Booster Installation Checklist

1. Convert child restraint to booster seat.

See "Converting into a Booster Seat," p. 52.

2. Secure booster seat to the vehicle seat.

Make sure the seat base is level with ground (p. 59). If necessary, a towel/small blanket may be rolled up and placed beneath the edge of the base. Make sure the bottom and back of the booster seat are touching vehicle seat and back.

IMPORTANT: You may use the Tether Strap and Lower Anchor Connectors to secure this booster seat to the vehicle seat as long as the position of the booster seat in the vehicle and/or the resulting fit of the vehicle seat belt over the child **are not affected**.

3. Place the child in the booster seat.

✓ Make sure the booster seat is securely locked into Recline Position #3 (p. 58).

✓ Make sure the child's back and bottom are flat against the back and bottom surfaces of the booster seat.

4. Adjust headrest for proper shoulder belt fit.

The shoulder belt **MUST** cross midway between the child's shoulder and neck, as shown.

5. Secure child and booster seat to vehicle seat.

Stretch the lap/shoulder belt across the child and fasten the buckle. Make certain the shoulder belt is threaded through the shoulder belt guide, as shown.

6. Check your work.

Make sure the lap belt is stretched low and snug across the child's hips, within the lower belt guides, and fastened into the buckle. The shoulder belt must cross the child midway between his/her shoulder and neck.



⚠ WARNING

The shoulder belt **MUST NOT** cross the child's neck or fall off the child's shoulder. If you cannot adjust the shoulder belt to properly lay midway between the child's shoulder and neck **AND** at or above the shoulder, try another seating location or do not use the booster seat.

Converting into a Booster Seat

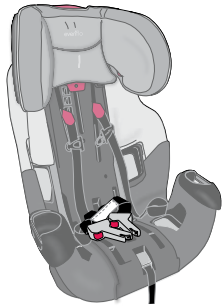

1. Remove the seat pad (p. 59).

Adjust the headrest to its uppermost position (p. 58).

Pull the Lower Anchor Connectors from the forward-facing belt path and place them in the seat, as shown.

2. Loosen harness.

Press the harness release button and pull the harness straps outward.

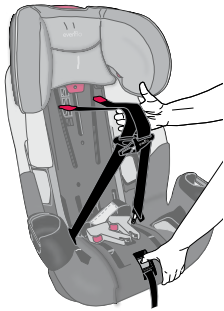

3. Push the chest clip and buckle tongues through the forward-facing belt path.

Buckle the chest clip behind the child restraint, as shown in the next illustrations, **A**, **B**, **C**.

A, **B**, **C**.

Buckled behind the Seat.

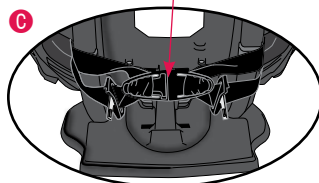
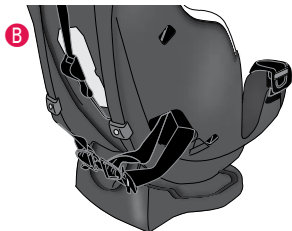
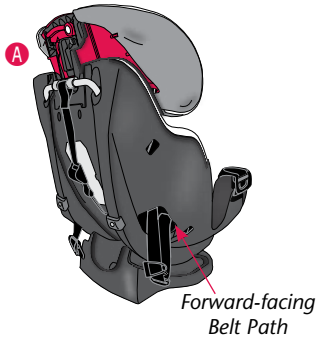

Converting into a Booster Seat

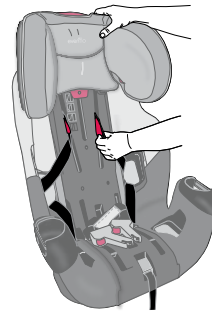

4. Conceal harness tabs.

Tuck harness tabs completely into adjustment slots, as shown.

Note: If the harness tabs are not tucked completely into the slots, they will press uncomfortably against your child's back.

5. Tighten harness straps.

Pull harness adjustment strap until harness straps are tight.

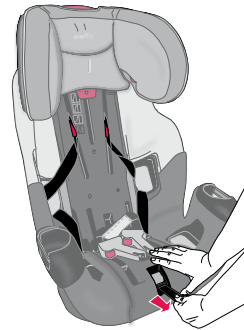

6. Insert Lower Anchor Connectors.

Insert both Lower Anchor Connectors through the forward-facing belt path.

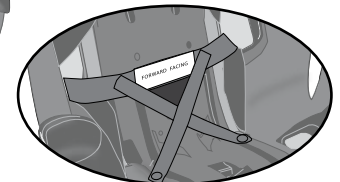
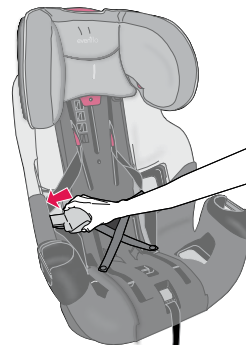

7. Remove the crotch strap.

Place the child restraint in **Recline Position #1** (p. 58), then lay it on its back. Locate the crotch strap anchor on the bottom.

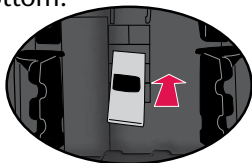
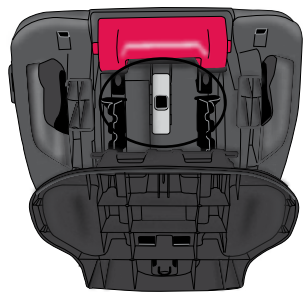

Unclip the anchor, push it through the seat, and remove, as shown.

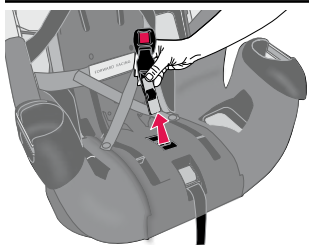

Insert the crotch strap anchor back into the opening from the bottom of the child restraint.

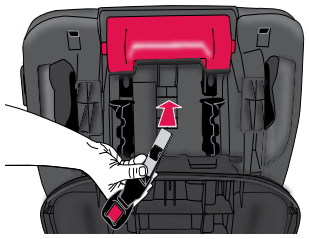

Pull the anchor completely through the seat and arrange it so it lies flat, as shown.

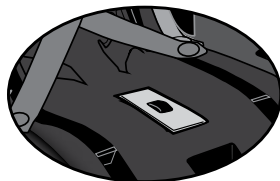
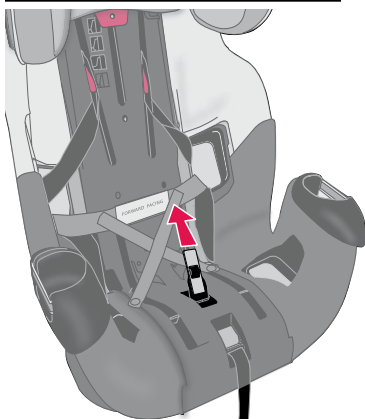

8. Install the seat pad.

Fasten each Lower Anchor Connector to its D-ring for storage (page 56).

IMPORTANT

Make sure the child restraint is adjusted to **Recline Position #3** (p. 58) and the headrest is adjusted for proper shoulder belt fit (p. 58).

Your child restraint is now in booster mode and ready for a child who weighs 18 to 49.8 kg (40 to 110 lbs), who is 112 to 145 cm (44 to 57 inches) tall, who is at least four years old, and whose ears are below the top of the child restraint headrest.

Note: to convert the seat back into 5-point harness mode, reverse these steps.

General Information

Using the SureLatch Connectors

Not available on all models.

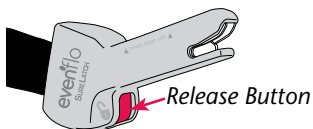

To remove the SureLatch Connector from a vehicle Lower Anchor Bar or from its storage D-ring, press the red Release Button.

When the SureLatch Lower Anchor Connector Assembly is in the **forward-facing belt path**, snap each SureLatch Connector onto a **forward D-ring** for storage.

When the SureLatch Lower Anchor Connector Assembly is in the **rear-facing belt path**, snap each SureLatch Connector onto a **rear D-ring** for storage.

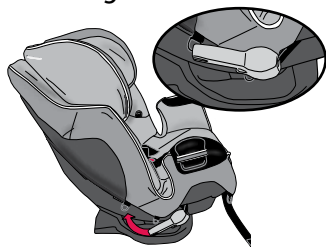
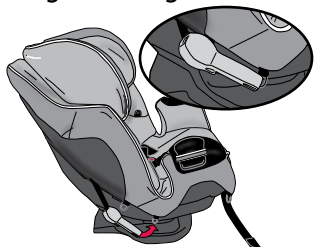

Using the Quick Connectors

Not available on all models.

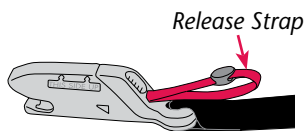

To remove the Quick Connector from a vehicle Lower Anchor Bar or from its storage D-ring, pull the red Release Strap.

When the Quick Connector Lower Anchor Connector Assembly is in the **rear-facing or forward-facing belt path**, snap each Quick Connector onto a D-ring in the front, as shown.

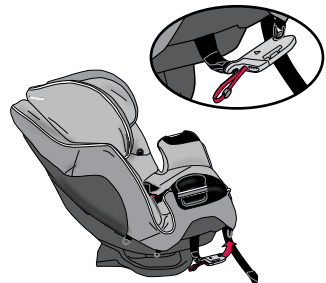
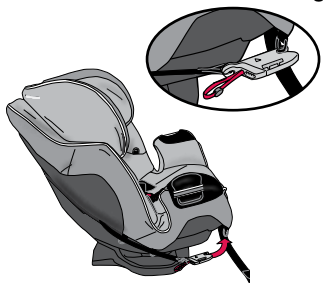

Removing the Tether Strap

1. Loosen the adjuster.

Press the adjuster release button **A** to loosen.

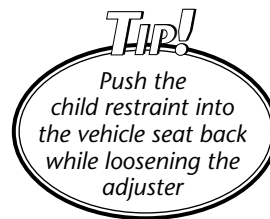
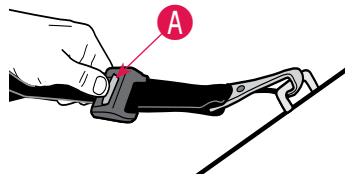

2. Remove the hook.

Press the tab **B** and twist, then remove the hook from the anchor **C**.

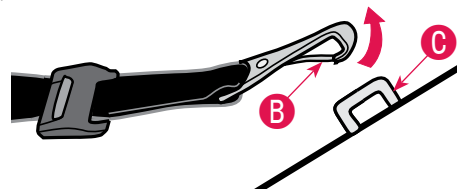

3. Attach Tether Hook to storage clip.

⚠ WARNING

- To avoid a strangulation hazard, you **MUST** tightly roll or fold excess or unused Tether Strap and secure with a rubber band.
- Attach the Tether Hook **D** to the storage clip when not in use. This will keep an unused Tether from hitting someone during a crash.

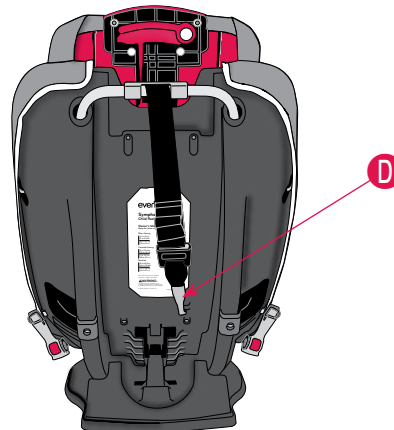

Adjusting the Headrest

Headrest Adjust Lever

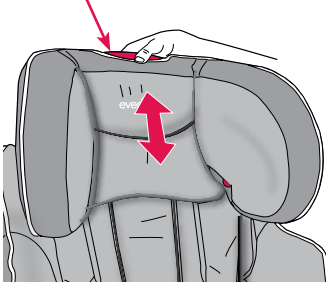

To adjust, squeeze the headrest adjust lever, as shown, while sliding the headrest up or down to the desired position.

Adjusting the Recline Position

This child restraint can be adjusted into three positions.

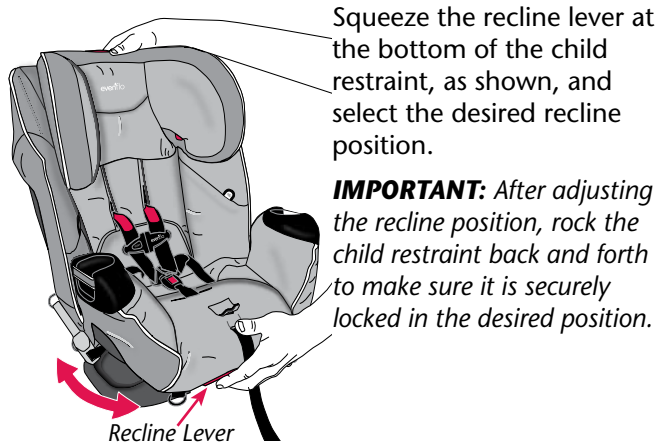

Squeeze the recline lever at the bottom of the child restraint, as shown, and select the desired recline position.

IMPORTANT: After adjusting the recline position, rock the child restraint back and forth to make sure it is securely locked in the desired position.

CORRECT RECLINE POSITIONING

- In rear-facing position: Use Recline Position #1 **ONLY**.
- In forward-facing position when child is secured with harness straps: Use Recline Position #2 for children who weigh 10 to 18 kg (22 to 40 lbs); use Recline Position #3 for children who weigh 10 to 29.4 kg (22 to 65 lbs).
- In booster mode: Use Recline Position #3 **ONLY**.

Removing the Seat Pad

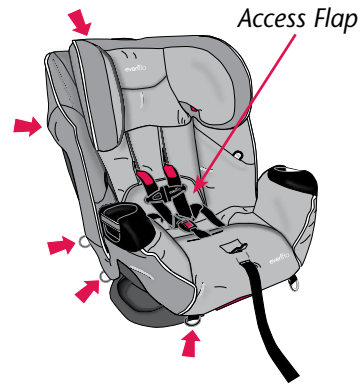

1. Disconnect all lower anchor connectors from the D-rings on the seat pad.
2. Open the access flap.
3. Disconnect all seat pad hooks. Remove the seat pad.

Booster Mode Seat Installation Positioning

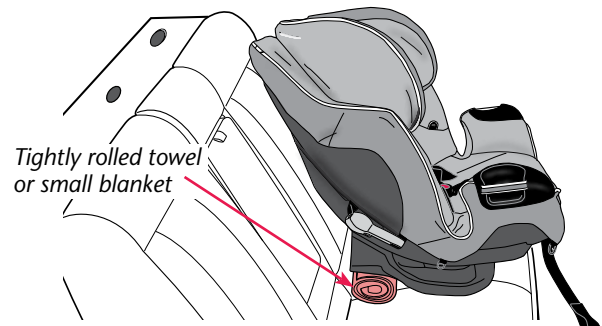

Insure base is level with ground.

If necessary, a towel/small blanket may be rolled up and placed beneath the edge of the base.

Installing the Accessories

⚠ WARNING

Use the Body Pillow and Infant Head Support (head pillow) with the child restraint in the rear-facing position **ONLY**.



The optional Body Pillow, when placed in the restraint, as shown, helps support your child.

IMPORTANT:

- The head pillow should lie flat against the seat back, as shown. Be sure to cut off the plastic attachment between the head support and the seat pad. Small parts may be a choking hazard.
- Support the child's head. Infants may have difficulty breathing when in a sitting position. Using additional padding or pillows behind the infant's head or failing to properly recline the child restraint could increase the child's risk of serious injury or death.

⚠ WARNING

- Use the fold-down cup holder* with the child restraint in the forward-facing position **ONLY**.
- **DO NOT** use the cup holders to store cans or hard cups. Only for use with soft cups (such as styrofoam or paper).
- **DO NOT** place any cups that contain hot liquids in the cup holders.
- **DO NOT** attach additional items to this child restraint that are not approved by Evenflo. Items not tested with the child restraint could injure the child.
- To install the fold-down cup holder **A**, move seat pad **B** out of the way and install the cup holder onto the side of the restraint.

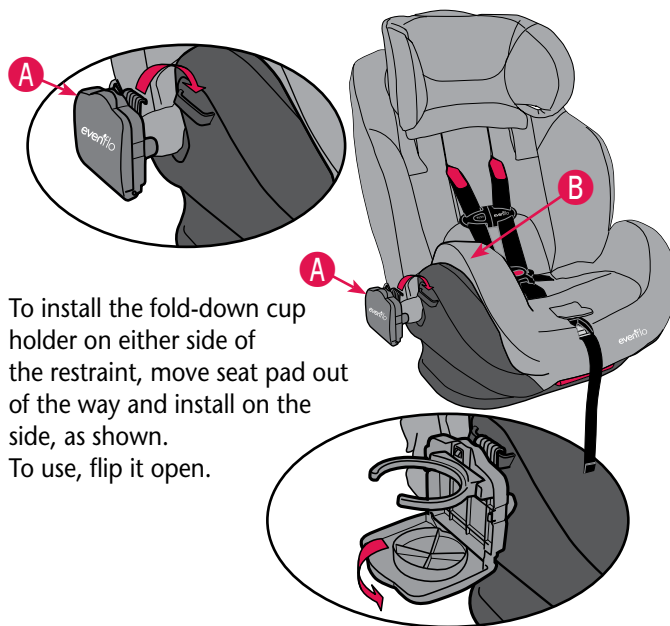

To install the fold-down cup holder on either side of the restraint, move seat pad out of the way and install on the side, as shown. To use, flip it open.

*Cup Holder style may differ from illustration.

Securing Your Child Restraint in Aircraft

The Federal Aviation Administration (FAA) recommends that you secure your child for air travel in an appropriate child restraint based on your child's weight and size. Turbulence can happen with little or no warning. When turbulence occurs, **the safest place for your child is in a properly installed child restraint, not in an adult's lap or on the aircraft seat with its seat belt.** Keeping your child in a child restraint during the flight will help ensure your family arrives safely at your destination.

The FAA recommends that a child weighing:

- more than 18 kg (40 lbs) use an aircraft seat belt;
- less than 9 kg (20 lbs) use a rear-facing child restraint; and
- from 9 to 18 kg (20 to 40 lbs) use a forward-facing child restraint.

Please note that these FAA recommendations may vary from those applicable to the use of your child restraint in a motor vehicle.

IMPORTANT

You must use the internal harness when installing the child restraint in aircraft.

Installing Child Restraint Rear-facing in Aircraft

IMPORTANT: Before installing the child restraint, make sure the **aircraft seat is in a fully upright position.**

Note: You may need to route the Lower Anchor Connector Assembly through the forward-facing belt path, if it interferes with the aircraft seat belt (p. 34). After landing, refer to page 20 for vehicle installation.

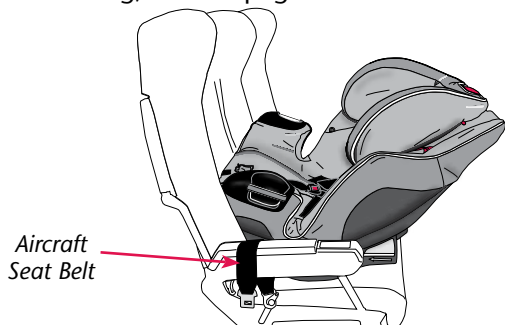

1. Place the child restraint in position.

Adjust the child restraint to its **most** reclined position (*Recline Position #1*, p. 58), then place it on the aircraft seat rear-facing, as shown.

Installing Child Restraint Rear-facing in Aircraft

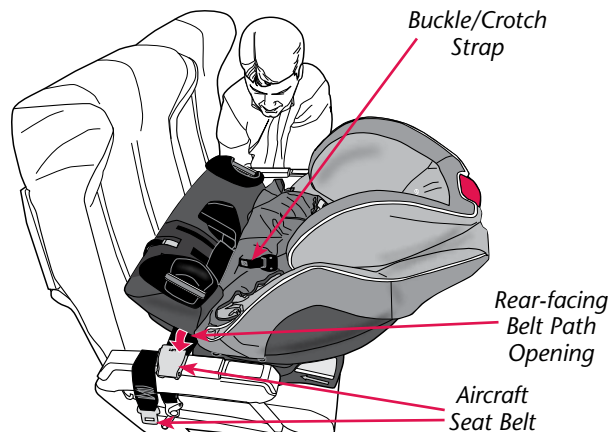

2. Route aircraft seat belt through rear-facing belt path.

Unhook the front of the child restraint's seat pad and move it out of the way. Route the aircraft seat belt buckle through the rear-facing belt path opening on one side and continue through the opening on the opposite side of the child restraint, as shown.

IMPORTANT: For aircraft use **ONLY**, make sure the aircraft seat belt is positioned **in front of** the buckle/crotch strap, as shown above.

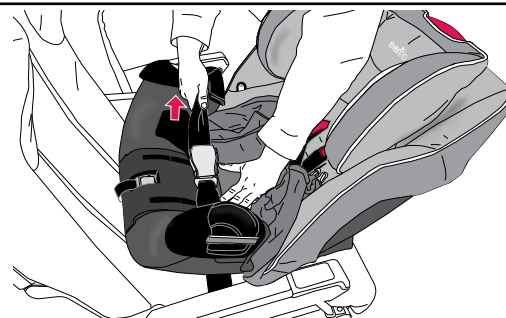

3. Fasten the aircraft seat belt, then remove all slack from the belt.

The aircraft seat belt must be as tight as possible. Using your full weight, push the child restraint firmly onto the aircraft seat while pulling on the seat belt to tighten. Route the excess seat belt strap through the rear-facing belt path opening.

Installing Child Restraint Rear-facing in Aircraft

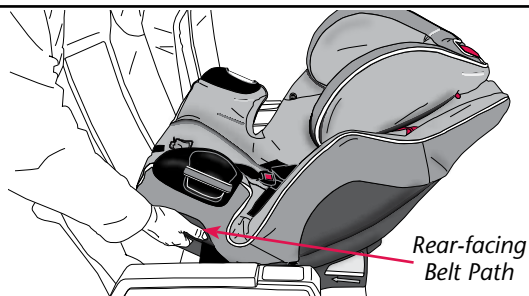

4. Check your work.

Reconnect the seat pad to the front of the child restraint. With your hand holding the seat shell at the rear-facing belt path, as shown, try to move the child restraint from side to side. Then, holding the seat shell at each rear-facing belt path, try to move the restraint from front to back.

If you can move the child restraint more than 25 mm (1 inch) from side to side or front to back **at the belt path**, the aircraft seat belt is not tight enough, and you **MUST** install again until the seat belt is tight.

Installing Child Restraint Forward-facing in Aircraft

IMPORTANT: Before installing the child restraint, make sure the **aircraft seat is in a fully upright position**.

Note: You may need to route the Lower Anchor Connector Assembly through the rear-facing belt path, if it interferes with the aircraft seat belt (p. 22). After landing, refer to page 32 for vehicle installation.

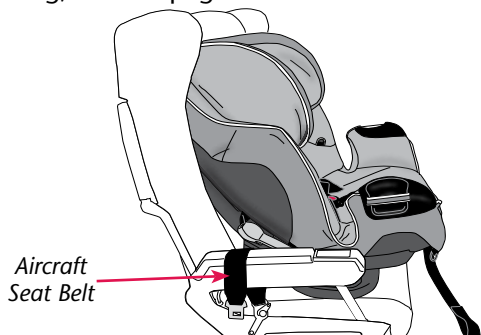

1. Place the child restraint in position.

Adjust the child restraint to its **most** upright position (*Recline Position #3*, p. 58), then place it on the aircraft seat forward-facing, as shown above.

Installing Child Restraint Forward-facing in Aircraft

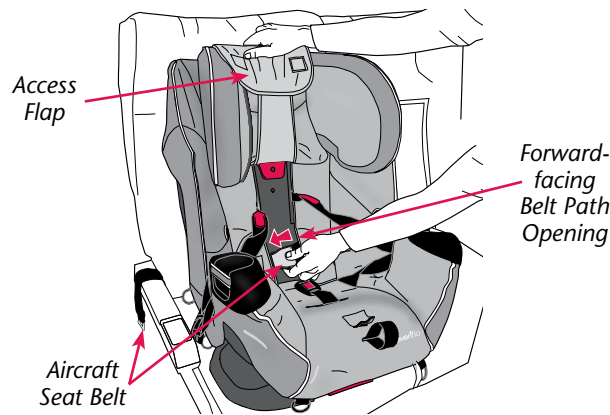

2. Route aircraft seat belt through forward-facing belt path.

Move the child restraint's harness out of the way and raise the access flap. Route the aircraft seat belt buckle through the forward-facing belt path opening on one side and continue through the opening on the opposite side of the child restraint, as shown above.

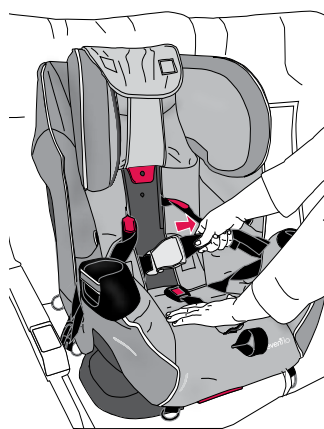

3. Fasten the aircraft seat belt, then remove all slack from the belt.

The aircraft seat belt must be as tight as possible. Using your full weight, push the child restraint firmly onto the aircraft seat while pulling on the aircraft seat belt to tighten. Route the excess seat belt strap through the forward-facing belt path opening.

Note: Because of the fixed length of aircraft seat belts, the belt buckle could be behind the child's back after tightening the belt. For your child's comfort, Evenflo recommends cushioning the child's back by placing a small pillow or folded-up blanket, or a folded-up jacket, over the belt buckle.

Installing Child Restraint Forward-facing in Aircraft

Care and Cleaning

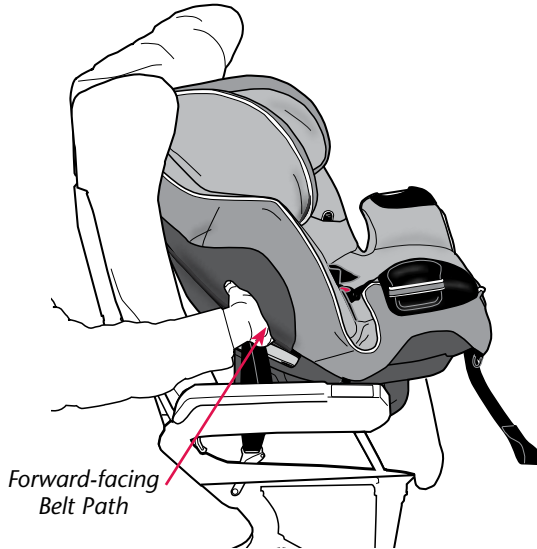

4. Check your work.

With your hand holding the seat shell at the forward-facing belt path, as shown, try to move the child restraint from side to side. Then, holding the seat shell at each forward-facing belt path, try to move the restraint from front to back.

If you can move the child restraint more than 25 mm (1 inch) from side to side or front to back **at the belt path**, the aircraft seat belt is not tight enough, and you **MUST** install again until the aircraft seat belt is tight.

- **DO NOT** lubricate or immerse in water the Lower Anchor Connectors, the buckle, or any other part of this child restraint, unless rinsing is permitted, as stated on the back of the buckle for your restraint.
- Plastic and metal parts may be wiped clean with mild soap and water and dried with a soft cloth. Do not use abrasive cleaners or solvents.
- Take care not to damage any labels.
- The harness can be wiped clean with mild soap and water. Allow harness to air dry.
- Machine wash the seat pad separately in cold water, delicate cycle. Tumble dry 10 to 15 minutes on low heat.
- **NEVER** use child restraint without the seat pad.
- To protect the child restraint from damage caused by weather, rodents, and other elements common to garages, the outdoors, and other storage locations, remove the seat pad and thoroughly clean the restraint and pad prior to storage. Take care to clean in the areas where crumbs and other debris tend to accumulate.

Tip! To help protect the vehicle upholstery, place a towel beneath and behind the child restraint.

Proper Disposal of This Child Restraint

At the end of this child restraint's useful life, Evenflo encourages you to dispose of it properly. Most of the components in this child restraint are recyclable.

1. Remove all fabric and padding.
 2. Remove all screws and disassemble the restraint.
 3. Recycle all plastic/foam parts and discard the rest.
- If your local recycling center won't accept the padding, you may dispose of it in the landfill.

Note: Evenflo uses recycled materials in the manufacturing process whenever possible but never for components that are critical for safety.

To prevent injury due to hidden damage, lost instructions, outdated technology, etc., discontinue use of this restraint after the expiration date on the label or if it has been involved in a crash.

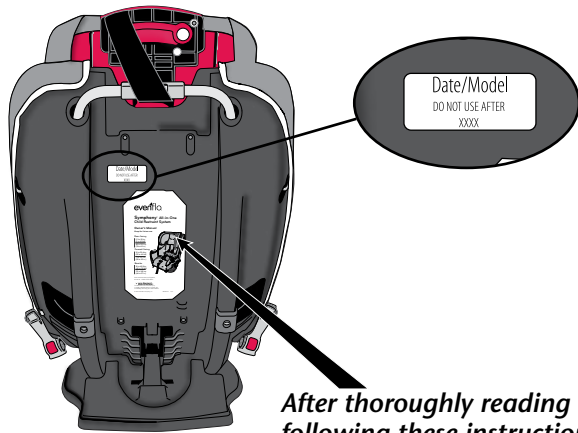

After thoroughly reading and following these instructions, store them in the slots provided on the back of the child restraint, as shown.

Not available on all models.

You can order replacement parts online at www.evenflo.com or call Evenflo. When you contact us, please have the product model number and date of manufacture (found on the back of the child restraint).



Locking Clip:
(Not included with child restraint)
see page 30 or 44

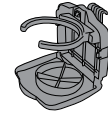

Cup Holder
(Cup Holder style may differ from illustration.)

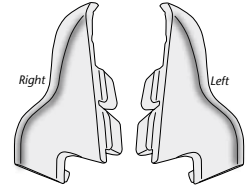

Upper Seat Foam



Head Pillow

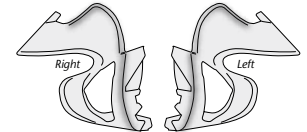

Lower Seat Foam



Crotch Buckle Pad



Body Pillow



Headrest Pad

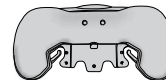

Headrest



Tether Extender
(Not included with child restraint)

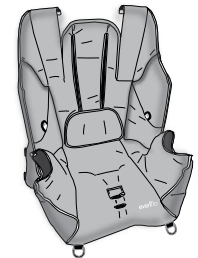

Seat Pad



SureLatch Lower Anchor Connector Assembly

Or



Quick Connector Lower Anchor Connector Assembly

Limited Warranty

For a period of 90 days from the original purchase of this Product, Evenflo warrants to the original end user ("Purchaser") this Product (including any accessories) against defects in material or workmanship. Evenflo's sole obligation under this express limited warranty shall be, at Evenflo's option, to repair or replace any Product that is determined to be defective by Evenflo and determined to be covered by this warranty.

Repair or replacement as provided under this warranty is the exclusive remedy of the Purchaser. Proof of purchase in the form of a receipted invoice or bill of sale evidencing that the Product is within the warranty period must be presented to obtain warranty service. This express limited warranty is extended by Evenflo ONLY to the original Purchaser of the Product and is not assignable or transferable to subsequent purchasers or end users of the Product. For warranty service, contact Evenflo's ParentLink Consumer Resource Center at **www.evenflo.com**.

EXCEPT TO THE EXTENT PROHIBITED BY APPLICABLE LAW, ANY IMPLIED WARRANTY OF MERCHANTABILITY OR FITNESS FOR A PARTICULAR PURPOSE ON THIS PRODUCT IS HEREBY DISCLAIMED. EVENFLO SHALL NOT BE LIABLE FOR ANY INCIDENTAL, CONSEQUENTIAL, SPECIAL OR PUNITIVE DAMAGES OF ANY KIND FOR BREACH OF THE EXPRESS LIMITED WARRANTY ON THIS PRODUCT, OR ANY WARRANTY IMPLIED BY OPERATION OF LAW. OTHER THAN THE EXPRESS LIMITED WARRANTY SET FORTH ABOVE, THERE ARE NO OTHER WARRANTIES THAT ACCOMPANY THIS PRODUCT AND ANY ORAL, WRITTEN OR ANY OTHER EXPRESS REPRESENTATION OF ANY KIND IS HEREBY DISCLAIMED.

ParentLink®

answers. advice. affirmation.™

- **USA:** 1-800-233-5921, 8 AM to 5 PM E.T.
- **Canada:** 1-937-773-3971
- **México:** 01-800-706-12-00