

Vulite®

4" TC NEW CONSTRUCTION HOUSING

INCANDESCENT LAMPS

V4TC W

Project: _____

Fixture Type: _____

Location: _____

Contact/Phone: _____

PRODUCT DESCRIPTION

TC Housing designed for use in non-insulated areas • If installed where insulation is present, the insulation must be pulled back 3" from all sides of the TC housing • In Canada, when insulation is present, type IC fixture must be used.

PRODUCT SPECIFICATIONS

Lamp Lamp ratings based on trim selected – see reverse.

Socket Floating medium base porcelain socket with nickel-plated copper screw shell • Shipped with socket cap to protect against paint overspray.

Trims Trim selection shown on reverse.

Labels UL/cUL listed for through-branch wiring, damp locations and IP
 • Product thermally protected against improper use of lamps or insulation
 • UL/cUL Listed • Trim V4012 is wet location approved for covered ceiling applications • Trims V4017 and V4034 are wet location approved for covered ceiling applications, **when used with outdoor rated lamps.**

Testing All reports are based on published industry procedures; field performance may differ from laboratory performance.

Specifications subject to change without notice.

INSTALLATION

Bar Hangers Telescoping bar hangers with captive nail allow for quick placement of housing anywhere within 24" O.C. joists • Can be installed in suspended ceiling grid using T-bar clip accessory • Bars scored in two locations for fast, clean breaking, allowing housing installation in tight applications • Edge-mounted for extra strength and captive to mounting frame • May be installed either perpendicular or parallel to junction box • Locking set screw locks fixture in position • Alternate mounting holes included.

Junction Box Pre-wired junction box provided with (5) 1/2" and (1) 3/4" knockouts, (4) Non-metallic sheathed cable connectors and ground wire, UL/cUL listed for through-branch wiring, maximum 8 No. 12 AWG 90° C branch circuit conductors (4 in, 4 out) • Junction box provided with removable access plates • Knockouts equipped with pryout slots.

Mounting Frame 22-gauge die-formed galvanized steel mounting frame
 • Rough-in section (junction box, mounting frame, housing and bar hangers) fully assembled for ease of installation.

Housing TC housing, 22-gauge aluminum • Housing is vertically adjustable to accommodate up to a 1" ceiling thickness.

DIMENSIONS

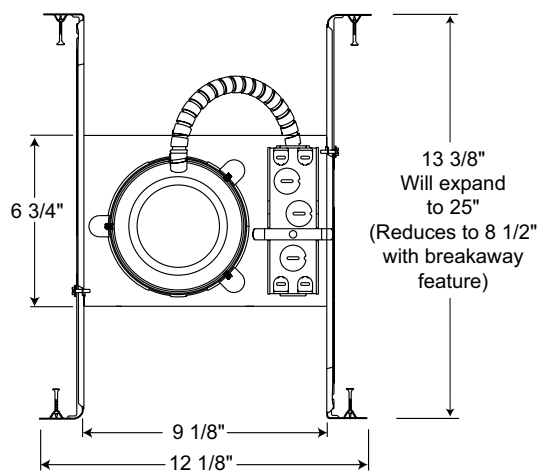
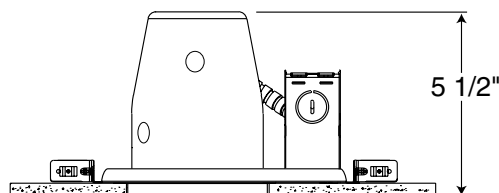

4 1/2" CEILING CUTOUT

ACCESSORIES

Catalog No.	Description
G2405	T-Bar Clips (Set of 4)

To order, specify catalog number

PRODUCT CODES





Catalog No.	Input Voltage	Lamp Rating (max.)
V4TC W	120V	PAR20/R20/PAR16/R16 (See reverse for max. trim rating)

4" TC NEW CONSTRUCTION HOUSING

INCANDESCENT LAMPS

V4TC W

TRIMS/LAMPS

	Cat. No.	Description	Max. Lamp Rating
	V4034 WWH◆◆ V4034 BWH◆◆	White Baffle Black Baffle	50W PAR20, 50W R20
	V4017 CWH◆◆	Clear Cone	50W PAR20, 50W R20
	V4010 WH	White Gimbal Ring	50W PAR20
	V4018 WH	White Eyeball	60W PAR16, 40W R16
	V4012 WH◆	Stippled Opal Lens Shower with Reflector	50W PAR20, 50W R20

Trim Size: 5" O.D.
 Trim Finish: WH - White.
 Note: In Canada when insulation is present, Type IC fixtures must be used.

- ◆ UL/cUL Listed for use in wet location.
- ◆◆ UL/cUL Listed for use in wet location with outdoor rated lamp.