

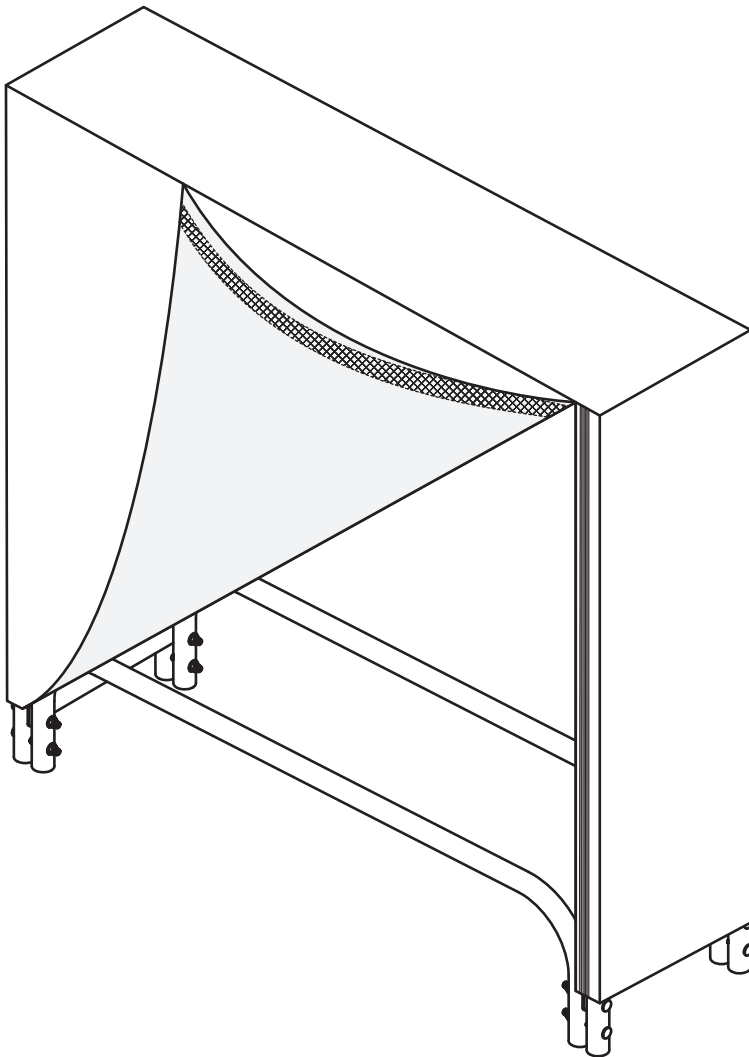







4-FOOT LOG RACK WITH COVER

QX-4LR-4LRC

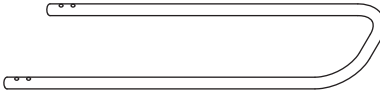
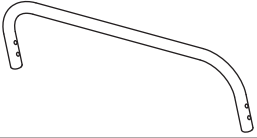
Read assembly instructions carefully and follow the care instructions. Save this document for future reference.
Assemble components on a soft, clean surface to avoid scratching or damaging the finish.



 Inspect packaging to ensure all parts are accounted for before disposing of packing materials.
 Save the packing slip.

| No. | PARTS | | QTY. |
|-----|---|--------------|------|
| A |  | End Panel | 2 |
| B |  | Rail | 2 |
| C |  | Brace | 2 |
| D |  | M8x75mm Bolt | 8 |
| E |  | Lock Nut | 8 |
| F |  | Washer | 12 |
| G |  | Spanner | 2 |
| H |  | Cover | 1 |

WARNING

CHOKING HAZARD — This item contains small parts that can be swallowed. Keep children and pets away during assembly.

 WARNING: Manufacturer and seller expressly disclaim any and all liability from personal injury, property damage or loss, whether direct or indirect, or incidental, resulting from the incorrect attachment, improper use, inadequate maintenance, or neglect of this product.

ASSEMBLY

Review all information and understand assembly before beginning.

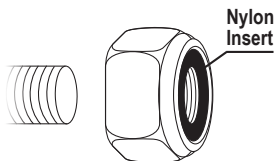

! IMPORTANT: Lock nuts must be installed with the nylon insert on the outside. Tools are required to fully tighten lock nuts, failure to properly tighten the lock nuts may result in product malfunction or personal injury.

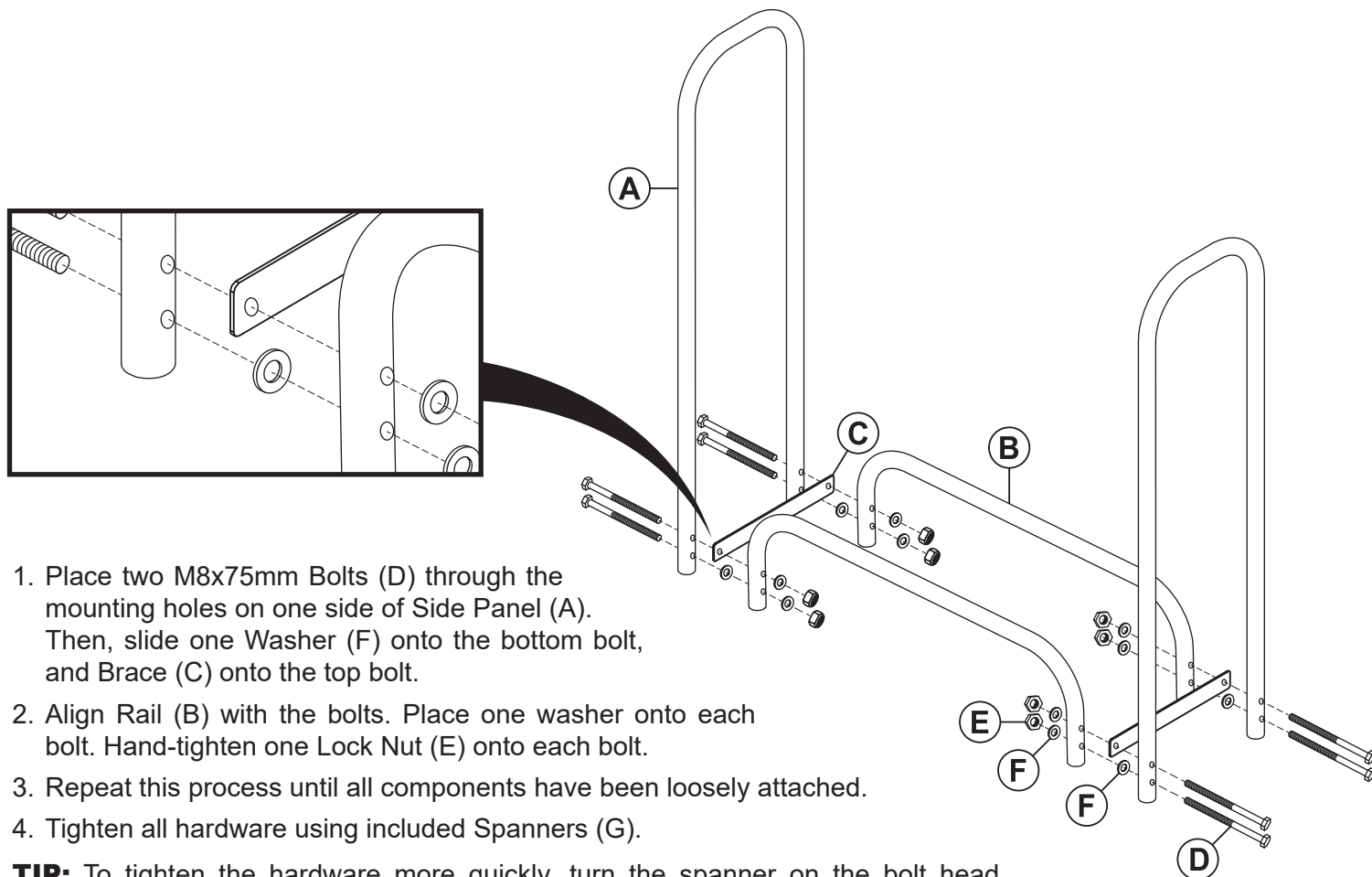

1. Place two M8x75mm Bolts (D) through the mounting holes on one side of Side Panel (A). Then, slide one Washer (F) onto the bottom bolt, and Brace (C) onto the top bolt.
2. Align Rail (B) with the bolts. Place one washer onto each bolt. Hand-tighten one Lock Nut (E) onto each bolt.
3. Repeat this process until all components have been loosely attached.
4. Tighten all hardware using included Spanners (G).

TIP: To tighten the hardware more quickly, turn the spanner on the bolt head clockwise while simultaneously turning the spanner on the lock nut counterclockwise.

! SAFETY STATEMENTS & WARNINGS !

- Place log rack on a hard, dry surface.
- Do not overload the log rack — holds approximately 1/2 face-cord of firewood.
- Ensure fittings are tight before use. Periodically check and tighten hardware as necessary.
- Protect the unit from outdoor elements with the included cover.
- Do not allow children to play with or around the log rack.

Any modification to the product or failure to follow recommended care will void the product warranty.

! WARNING!

Manufacturer and seller expressly disclaim any and all liability from personal injury, property damage or loss, whether direct or indirect, or incidental, resulting from the incorrect attachment, improper use, inadequate maintenance, or neglect of this product.