

WWT  
WESTINTRENDS  
WWT

DESIGNED IN CALIFORNIA

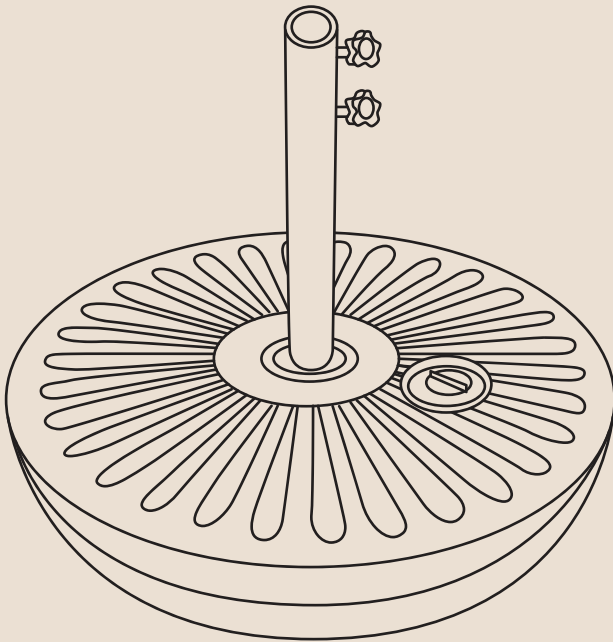

— 20" ROUND HARD PLASTIC FREE —  
STANDING UMBRELLA BASE

# THANK YOU!

We appreciate you for choosing WestinTrends!

Thank you for letting WestinTrends continue to offer accessible luxury trends, inspired by everyone!

---

## JOIN THE WESTINTRENDS COMMUNITY

Sign up here:

[\*\*\*https://westintrends.com/welcome\*\*\*](https://westintrends.com/welcome)



## QUESTIONS OR COMMENTS?

If you have questions reach out to  
[\*\*cs@westintrends.com\*\*](mailto:cs@westintrends.com)

---

FOLLOW, SHARE, & LEARN



## PRODUCT REGISTRATION

[\*\*\*https://westintrends.com/apps/product-registration\*\*\*](https://westintrends.com/apps/product-registration)



## ! CARE & MAINTENANCE

- Only fill with water when used in warm climates.
- Do not fill with water if exposed to freezing temperatures.
- Formation and expansion of ice may crack the base.

## TOOLS REQUIRED



1 PERSON  
ASSEMBLY



UP TO 30 MIN.  
ASSEMBLY

## HARDWARE

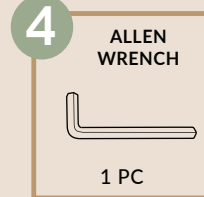
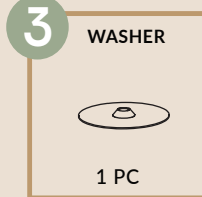
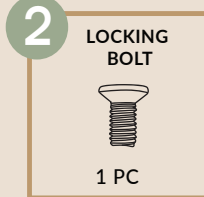
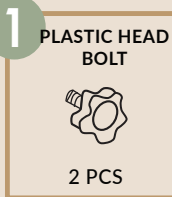

## PARTS

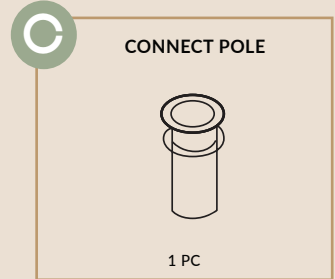
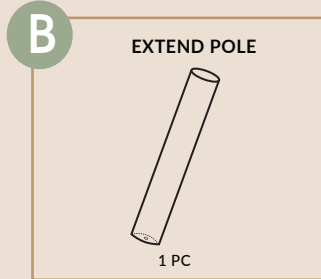
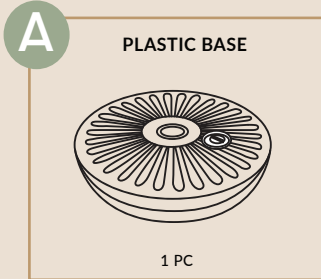

## PRODUCT ASSEMBLY

1

Put **Part B Extend Pole** into **Part A Plastic Base**, attach **Hardware #2 Locking Bolt** and **Hardware #3 Washer** to **Part B Extend Pole**.

Pay attention that **Part C Connect Pole** is already assembled on head of **Part B Extend Pole**.

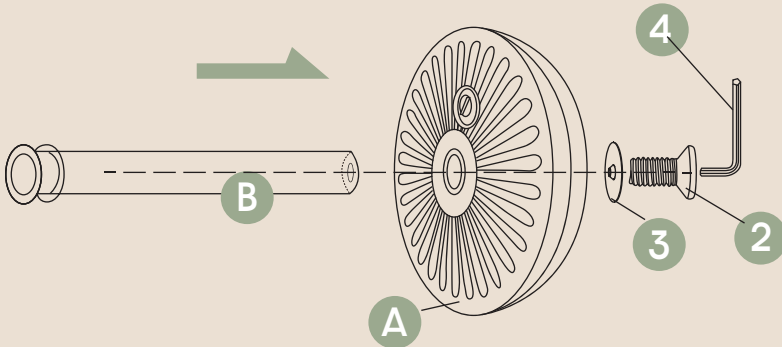

2

Check the diameter of your umbrella pole and choose part C1 / C2 in suitable size.

- Take out part C1 and leave part C2 when the diameter is 48mm;
- Keep both C1 and C2 when the diameter is 38mm.

Insert your umbrella pole into **Part B Extend Pole**.

Attach 2 pcs of **Hardware #1 Plastic Head Bolt** onto **Part B Extend Pole**, then tighten them to keep your umbrella stable.

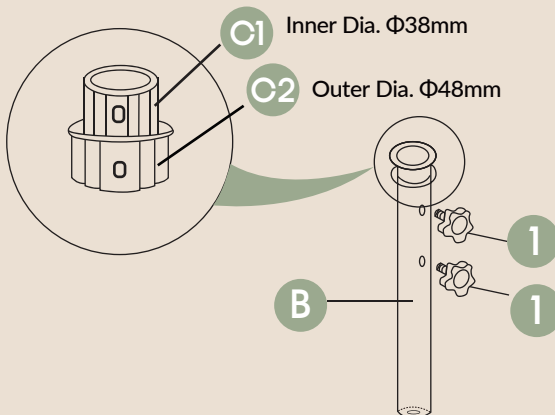

## PRODUCT ASSEMBLY

3

Take off the cap and fill in with sand or water.

Seal the cap back and finish the assembly of base.

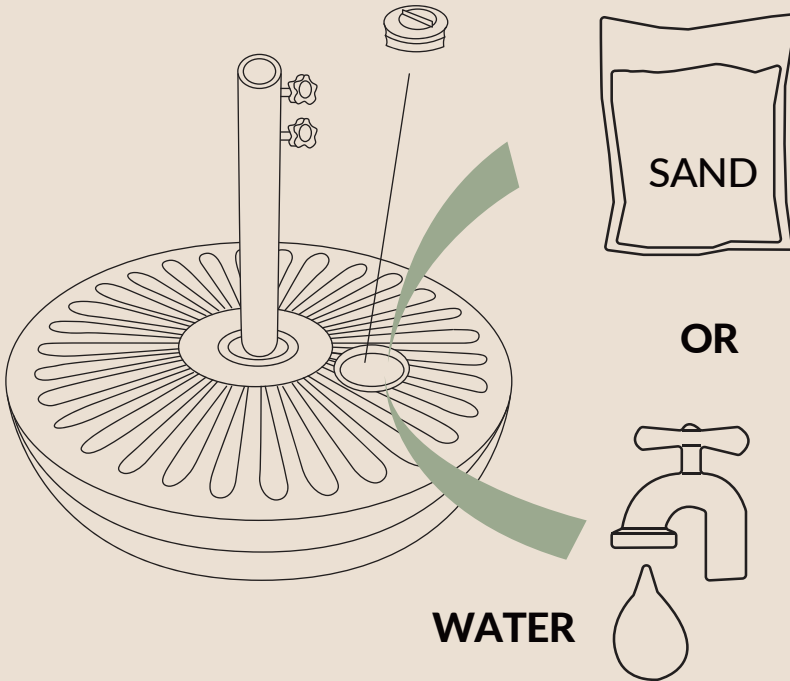

### CAUTION:

The plastic base will be very heavy after filling with sand or water. Be very careful when moving these plastic bases in case of hurting your feet or destroy the plastic base.

Thank you for purchasing this quality product.

## REGISTRATION & REFUND POLICY

<https://westintrends.com/apps/product-registration>



<https://westintrends.com/policies/refund-policy>



### HAVING TROUBLE

- **Not sure how to assemble or missing pieces?**

Please contact our Customer Service Team for assistance at [cs@westintrends.com](mailto:cs@westintrends.com)

**Have Order #, Part # or SKU ready to speed up customer service!**

### CLEANING TIPS

**REGULAR CLEAN:** Use a mixture of warm water and mild soap. Gently scrub the surface with a soft bristle brush to remove any dirt or stains.

**QUICK CLEAN:** You can simply wipe down the HDPE furniture with a damp cloth. The material's resilience makes it resistant to most spills and stains, ensuring a hassle-free maintenance routine.

*Regular cleaning not only preserves the aesthetic appeal of your furniture but also helps extend its lifespan.*

Pressure washer can be used for seriously deep-cleaning - **DO NOT exceed 1500 PSI** - this will remove debris and dirt.