

WALLMOUNT ELECTRIC FIREPLACE

| Model | BTU | Width | Height | Depth | Viewing Area |
|-------------|-------|-------|--------|---------|--------------|
| CEFL32FH-1 | 5,000 | 32 | 21 5/8 | 4 15/16 | 12 X 22 9/16 |
| CEFL42FH-1 | | 42 | | | 12 X 32 9/16 |
| CEFL50FH-1 | | 50 | | | 12 X 40 9/16 |
| CEFL60FH-1 | | 60 | | | 12 X 50 1/2 |
| CEFL72FH-1 | | 72 | | | 12 X 62 9/16 |
| CEFL100FH-1 | | 100 | | | 12 X 90 9/16 |

DIMENSIONS

FRONT VIEW

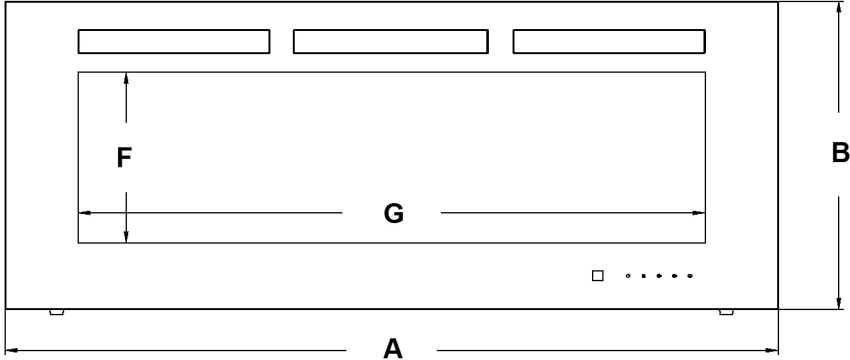

SIDE VIEW

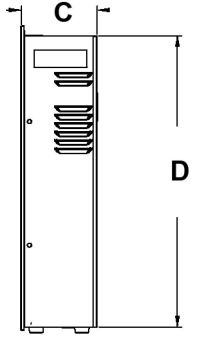

TOP VIEW

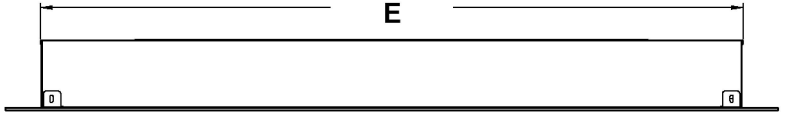

| | A | B | C | D | E | F | G |
|--------------------|------------------|--------------------|---------------------|--------------------|----------------------|----------------|----------------------|
| CEFL32FH-1 | 32" (813mm) | 21 5/8" (550mm) | 4 15/16" (125mm) | 20 1/2" (520mm) | 27 5/16" (695mm) | 12" (304mm) | 22 9/16" (573mm) |
| CEFL42FH-1 | 42" (1067mm) | | | | 37 1/2" (951mm) | | 32 9/16" (827mm) |
| CEFL50FH-1 | 50" (1270mm) | | | | 45 7/16" (1154mm) | | 40 9/16" (1030mm) |
| CEFL60FH-1 | 60" (1524mm) | | | | 55 5/16" (1405mm) | | 50 1/2" (1284mm) |
| CEFL72FH-1 | 72" (1830mm) | | | | 67 3/8" (1711mm) | | 62 9/16" (1590mm) |
| CEFL100FH-1 | 100" (2540mm) | | | | 95 3/8" (2422mm) | | 90 9/16" (2300mm) |

WALLMOUNT ELECTRIC FIREPLACE

MINIMUM CLEARANCE TO COMBUSTIBLES

| Measurements are taken from the glass front | |
|---|---------------------------------|
| Bottom | 0" |
| Sides | 0" |
| Back | 0" |
| Top | 8" (20.3cm) to ceiling / mantel |

| Measurements are taken from the body | |
|--------------------------------------|----|
| Sides, back, and top | 0" |

MINIMUM MANTEL CLEARANCES

! WARNING

- When using paint or lacquer to finish a mantel, the paint or lacquer must be heat resistant to prevent discoloration.

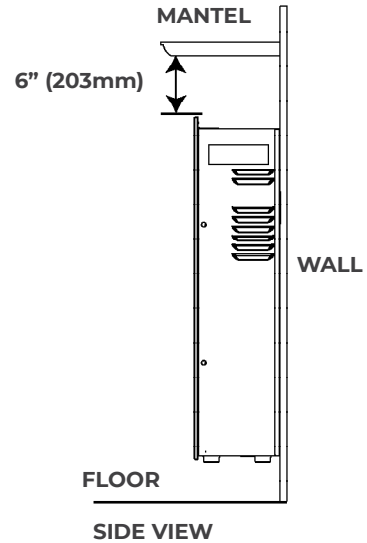

FRAMING

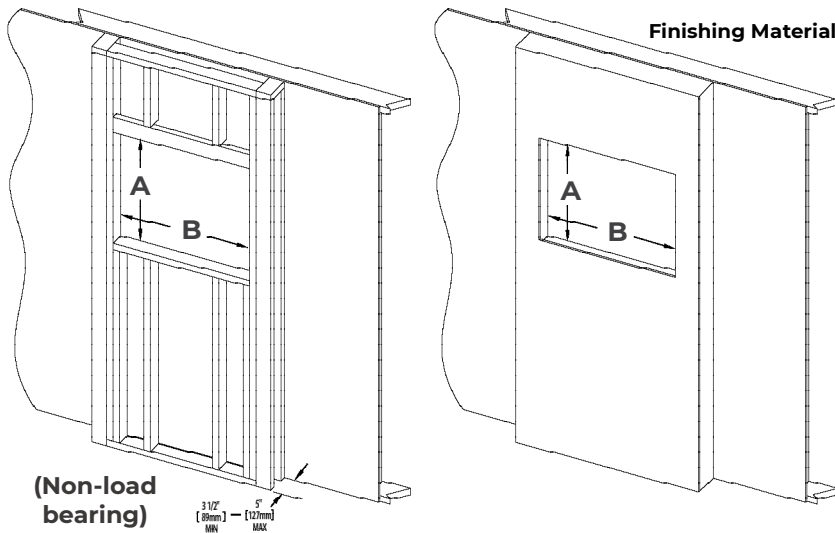

| MODEL NO. | A | B |
|-------------|-----------------|------------------------|
| CEFL32FH-1 | 21" (53.5cm) | 27 13/16" (70.7cm) |
| CEFL42FH-1 | | 38" (96.5cm) |
| CEFL50FH-1 | | 45 15/16" (116.6cm) |
| CEFL60FH-1 | | 55 13/16" (141.8cm) |
| CEFL72FH-1 | | 67 7/8" (172.5cm) |
| CEFL100FH-1 | | 95 7/8" (243.5cm) |

APPAREIL ÉLECTRIQUE MURAUX

| Modèle | BTU | Largeur | Hauteur | Profondeur | Dimensions de Vision |
|-------------|-------|---------|---------|------------|----------------------|
| CEFL32FH-1 | 5,000 | 32 | 21 5/8 | 4 15/16 | 12 X 22 9/16 |
| CEFL42FH-1 | | 42 | | | 12 X 32 9/16 |
| CEFL50FH-1 | | 50 | | | 12 X 40 9/16 |
| CEFL60FH-1 | | 60 | | | 12 X 50 1/2 |
| CEFL72FH-1 | | 72 | | | 12 X 62 9/16 |
| CEFL100FH-1 | | 100 | | | 12 X 90 9/16 |

DIMENSIONS

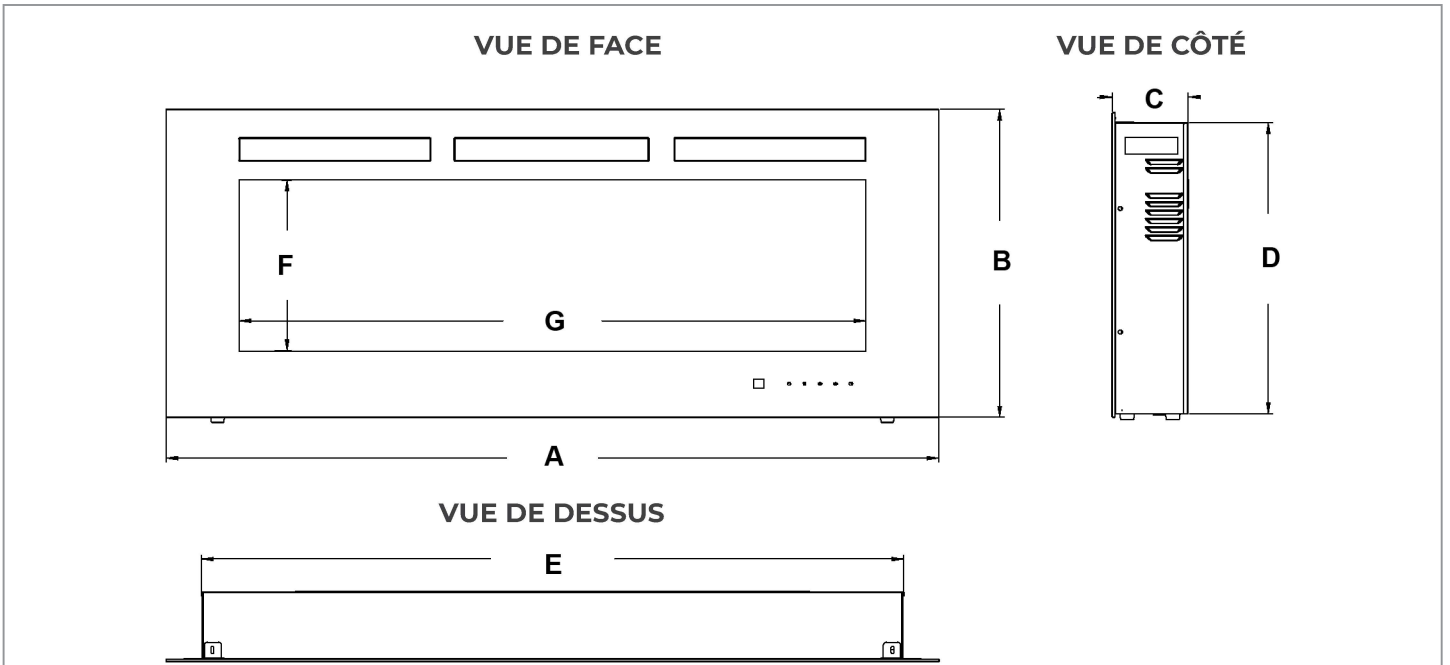

| | A | B | C | D | E | F | G |
|--------------------|------------------|--------------------|---------------------|--------------------|----------------------|----------------|----------------------|
| CEFL32FH-1 | 32" (813mm) | 21 5/8" (550mm) | 4 15/16" (125mm) | 20 1/2" (520mm) | 27 5/16" (695mm) | 12" (304mm) | 22 9/16" (573mm) |
| CEFL42FH-1 | 42" (1067mm) | | | | 37 1/2" (951mm) | | 32 9/16" (827mm) |
| CEFL50FH-1 | 50" (1270mm) | | | | 45 7/16" (1154mm) | | 40 9/16" (1030mm) |
| CEFL60FH-1 | 60" (1524mm) | | | | 55 5/16" (1405mm) | | 50 1/2" (1284mm) |
| CEFL72FH-1 | 72" (1830mm) | | | | 67 3/8" (1711mm) | | 62 9/16" (1590mm) |
| CEFL100FH-1 | 100" (2540mm) | | | | 95 3/8" (2422mm) | | 90 9/16" (2300mm) |

APPAREIL ÉLECTRIQUE MURAUX

DÉGAGEMENTS MINIMAUX AUX COMBUSTIBLES

| Les mesures sont prises à partir de la façade vitrée | |
|--|--|
| Bas | 0" |
| Côtés | 0" |
| Arrière | 0" |
| Dessus | 8" (20,3cm) au plafond / à la tablette |

| Les mesures sont prises du corps | |
|----------------------------------|----|
| Côtés, arrière, et dessus | 0" |

DÉGAGEMENTS MINIMAUX DE LA TABLETTE

⚠ AVERTISSEMENT

- Lors de l'utilisation de la peinture ou laque pour la finition de la tablette, la peinture ou laque doivent être résistants à la chaleur pour empêcher la décoloration.

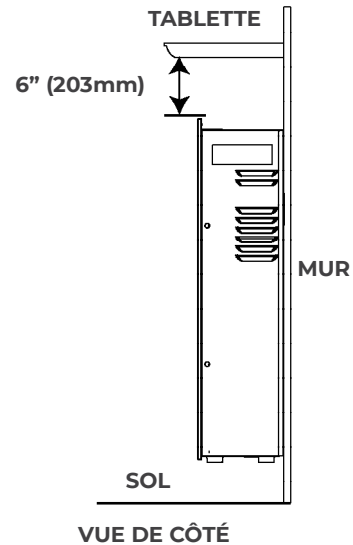

OSSATURE

(Palier non porteur)

3 1/2" [89mm] MIN — 5" [127mm] MAX

Matériel de Finition

| No. de Modèle | A | B |
|---------------|-----------------|------------------------|
| CEFL32FH-1 | 21" (53,5cm) | 27 13/16" (70,7cm) |
| CEFL42FH-1 | | 38" (96,5cm) |
| CEFL50FH-1 | | 45 15/16" (116,6cm) |
| CEFL60FH-1 | | 55 13/16" (141,8cm) |
| CEFL72FH-1 | | 67 7/8" (172,5cm) |
| CEFL100FH-1 | | 95 7/8" (243,5cm) |