

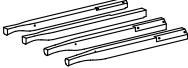





Note:

A packet with complete set of hardware can be found by pulling the red ribbon that's easily visible upon opening the box.

Assembly Instructions, #9077 Annette Side Table



A	Top Assembly		1
B	Legs		4
C	Shelf		1
D	Bolts		8
E	Lock Washers		8
F	Flat Washers		8
G	Allen Wrench		1
H	Shelf Supports		4

Step 1

1.1 Place the top assembly (A) upside down on a soft surface and open the drawer.

1.2 Attach four legs onto top assembly with the stickers on legs matched to the stickers of the top assembly.

1.3 Fasten four legs with 8 bolts, lock washers and flat washers.

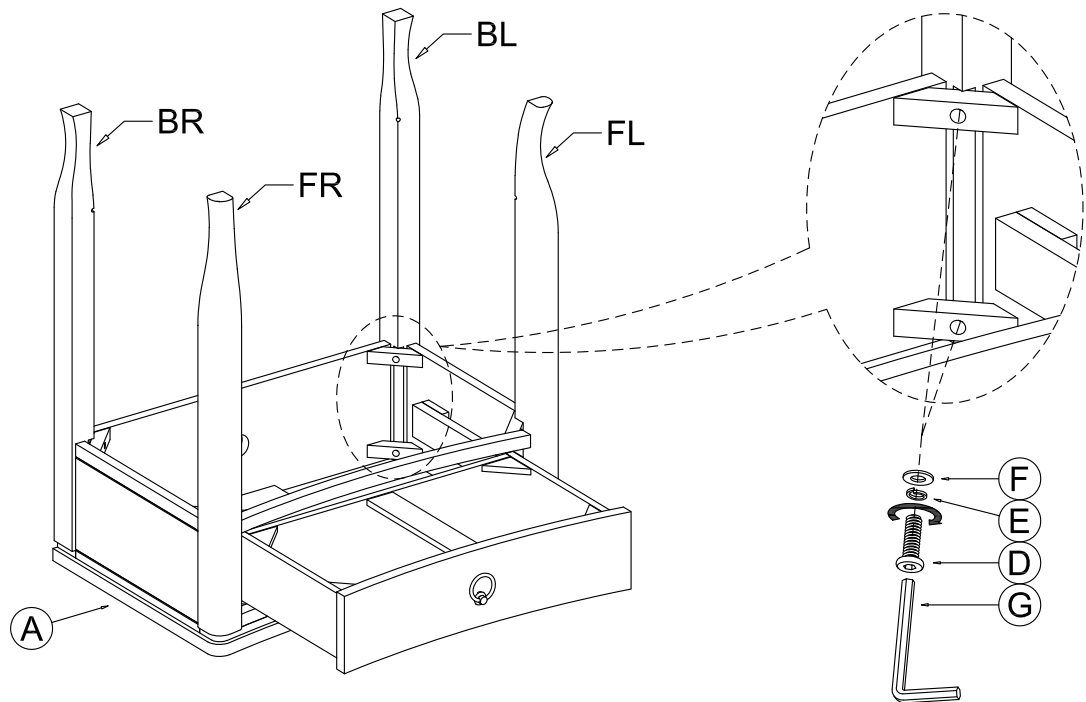

Step 2

2.1 Place the shelf (C) with back side facing up into the table assembly, hold the shelf and push it down slightly until it goes below the shelf support holes.

2.2 Insert four shelf supports.

2.3 Close the drawer and place the side table upright. Tap the shelf to fully rest on all shelf supports.

