

User's Manual

BV7340

**IN-DASH DVD/MP3/CD RECEIVER
WITH 3.2-INCH WIDESCREEN TFT MONITOR**

**WITH USB AND SD MEMORY CARD PORTS
AND FRONT PANEL AUX INPUT**



BV7340

**IN-DASH DVD/MP3/CD RECEIVER
WITH 3.2-INCH WIDESCREEN TFT MONITOR
WITH USB AND SD MEMORY CARD PORTS
AND FRONT PANEL AUX INPUT**

01.2010

tech support: www.bosssaudio.com/support



E4 10 R - 02 1011

BOSS Audio Systems • 3451 Lunar Court • Oxnard, CA 93030

www.bosssaudio.com

800.999.1236

BOSS[®]

AUDIO SYSTEMS

BOSS[®]

AUDIO SYSTEMS

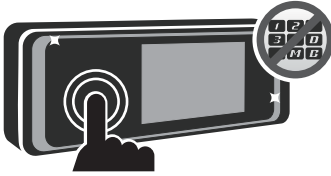
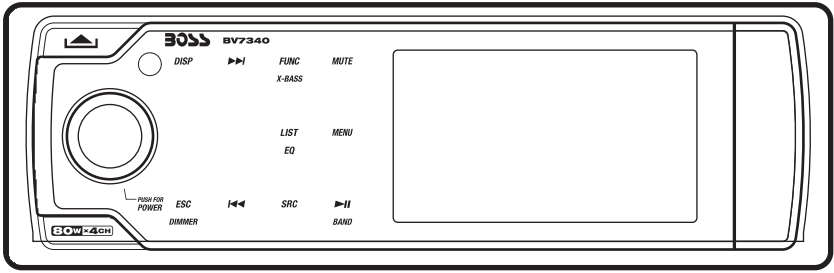

BUTTON LESS TOUCH PAD PANEL

This radio is equipped with the most advanced "TOUCH SENSE PANEL", so that it is easy and convenient to use while driving.

Tips Here are some tips to show you how easy it is to use this touch sense panel:

- Using a very light touch on the radio panel will activate that feature. You will not need to "PRESS" hard on the panel to make this radio change features.
- The power button along with some of the buttons that have dual functions, will need to be "TOUCHED" from 2 to 3 seconds to make the change.
- The best area to "TOUCH" on the panel to make it activate is the illuminated or lighted area. For example, just touch for 2 to 3 seconds the illuminated power symbol and the unit will turn on or off.

WARNINGS

► When Driving

Keep the volume level low enough to aware of the road and traffic conditions.

▲ CAUTION

In some countries, it's unlawful to operate a vehicle while video is displayed in the driver's viewing area. Please always switch the unit's display to "Font Type Display" mode by pressing the DISP button while driving.

For safety reason, the driver should only enjoy / watch the video while the car is in parking mode.

► When Car Washing

Do not expose the product to water or excessive moisture. This could cause electrical shorts, fire or other damage.

▲ CAUTION

In order to avoid any accident, the driver must not watch video while driving. This unit is designed to not allow watching moving video while driving. Park your car in a safe place and engage the 'PARKING BRAKE WIRE' before watching moving video.

► When Parked

Parking in direct sunlight can produce very high temperatures inside your vehicle. Give the interior a chance to cool down before starting playback.

► Use the Proper Power Supply

This product is designed to operate with a 12 volt DC, negative ground battery system (the regular system in a North American car).

► Protect the Disc Mechanism

Avoid inserting any foreign objects into the slot of this player. Failure to follow this may cause malfunction or permanent damage due to the precise mechanism of this unit.

▲ CAUTION

THIS MOBILE MultiMedia PLAYER IS A CLASS I LASER PRODUCT. THIS UNIT USES A VISIBLE/INVISIBLE LASER BEAM WHICH COULD CAUSE HAZARDOUS RADIATION IF EXPOSED DIRECTLY. BE SURE TO OPERATE THE MOBILE MultiMedia PLAYER CORRECTLY AS INSTRUCTED.

USE OF CONTROLS OR ADJUSTMENTS OR PERFORMANCE OR PROCEDURES OTHER THAN THOSE SPECIFIED HEREIN MAY RESULT IN HAZARDOUS RADIATION EXPOSURE.

DO NOT OPEN COVERS AND DO NOT REPAIR BY YOURSELF PLEASE REFER SERVICING TO A QUALIFIED TECHNICIAN.

NOTE:

1. TO REDUCE THE RISK OF FIRE OR ELECTRIC SHOCK, DO NOT EXPOSE THIS EQUIPMENT TO RAIN OR MOISTURE.
2. TO REDUCE THE RISK OF FIRE OR ELECTRIC SHOCK, AND ANNOYING INTERFERENCE, USE ONLY THE RECOMMENDED ACCESSORIES.
3. THIS DEVICE IS INTENDED FOR CONTINUOUS OPERATION.

This product incorporates copyright protection technology that is protected by method claims of certain U.S. Patents and other intellectual property rights owned by Macrovision Corporation and other rights owners. Use of this copyright protection technology must be authorized by Macrovision Corporation, and is intended for home and other limited viewing uses only unless otherwise authorized by Macrovision Corporation. Reverse engineering or disassembly is prohibited.

DISC AND FORMAT SUPPORTS

This unit can play various video/audio format which stored into Disc/USB or SD card on Media Player.

The following chart helps you to check if a disc is supported by this unit, as well as what functions are available for a given disc type.

Disc format
Digital Versatile Discs (MultiMedias)
Video CDs (VCDs)
Digital Versatile Discs Recordable (MultiMedia+/-R)
Digital Versatile Discs Rewritable (MultiMedia+/-RW)
Compact Discs (CDs)
CD Recordable (CD-R)
CD Rewritable (CD-RW)

▶ Audio Format

Playback CD-DA and MP3 or WMA digital music file on CD-ROM or MultiMedia-ROM or USB or Memory Card.

Note of MP3 and WMA:

Support Maximum 2000 files
 Maximum 30 characters display
 Supported Sampling frequencies; 32kHz, 44.1kHz, 48kHz.
 Supported Bit-Rates: 64-256 kbps variable bit rate

▶ Video Format

Playback IMAGE JPEG, MultiMedia Video, MPEG4 . On CD-ROM or MultiMedia-ROM or USB or SD.card

Noted of MPEG4

Supported decoding MPEG-4 video defined by ISO 14496-2 Standard:

1. Simple Profile (SP) and
2. Advance Simple Profile (ASP)

Supported file format: MP4 and .M4a (audio only)

▶ Unsupported Discs

8 cm Disc
 CDV, CDI, CDG,
 LD
 MultiMedia RAM

▶ Note on Region Code

MultiMedia players and MultiMedia Video discs Have their own Region Code numbers. This unit Can play the disc of all  region code numbers.

▶ Disc Maintenance

Before playing, wipe the disc using a clean cloth, working from the center hole towards the outside edge.

Never use benzene, thinners, cleaning fluids or anti-static liquids or any other solvent.



NOTE

A disc may become somewhat scratched (although not enough to make it unusable) depending on you handle it and conditions in the usage environment. Note these scratches are not an indication of any problem with the player.

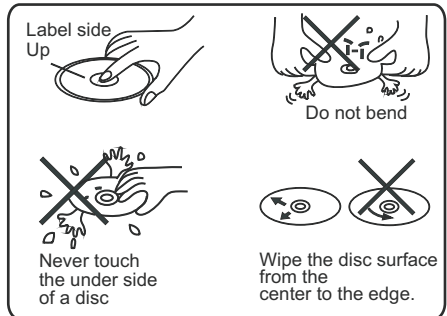

INSTALLATION

The following illustration shows a typical installation. If you have any questions or require information regarding installation kits, consult your customer car audio dealer or a company supplying kits.

If you are not sure how to install this unit correctly, have it installed by a qualified technician.

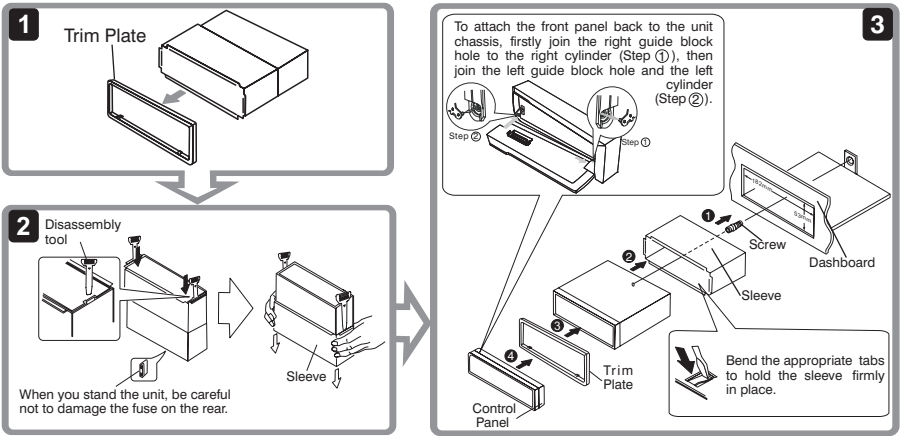

Removing the unit

Before removing the unit, release the rear section.

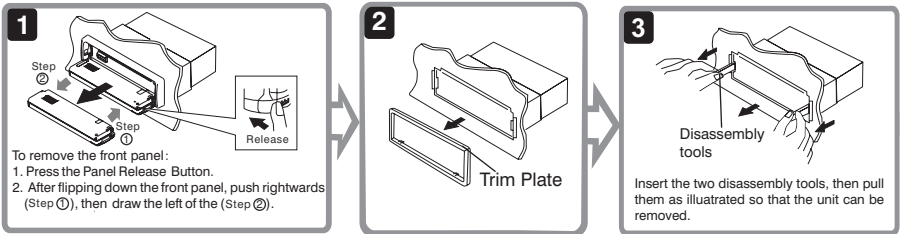

When using the optional stay

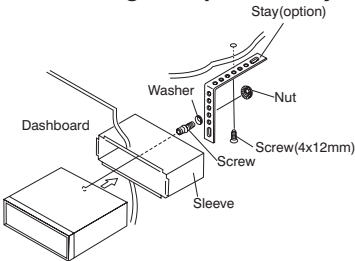

When installing the unit without using the sleeve

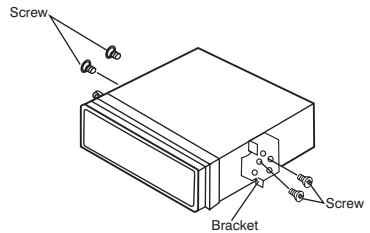

Installation using the screw holes on the sides of the unit. Fastening the unit to the factory radio mounting bracket.

CONNECTING THE SYSTEM

About Parking Wire

▲ CAUTION

In order to avoid any accident, the driver must not watch video while driving. This unit is designed to not allow watching moving video while driving. Park your car in a safe place and engage the parking brake before watching moving video.

NOTE

The Video Blocking system under Parking Brake **NOT ENGAGED** only control this unit's display, This system will not affect the Video Output thru the rear RCA Video Output.

TIPS

Be sure to connect Parking Brake connection lead. (please see more details on " Wiring Diagram.")

NOTE

If watch moving video from Disc or AV In source but Parking Brake is **NOT PROPERLY CONNECTED**, the video signal will be blocked by the system.

About The Reverse Wire For Back Up Camera System

If user connected a back up camera system to this unit, when the vehicle is in reverse Gear (Back Up mode), the front in-dash TFT display will automatically switch to Back Up Camera Video signal regardless whatever mode is currently displayed on the front in-dash TFT.

Tips

Be sure to connect Reverse wire properly. (please see more details on " Wiring Diagram.")

CONNECTING THE SYSTEM

Wiring Diagram

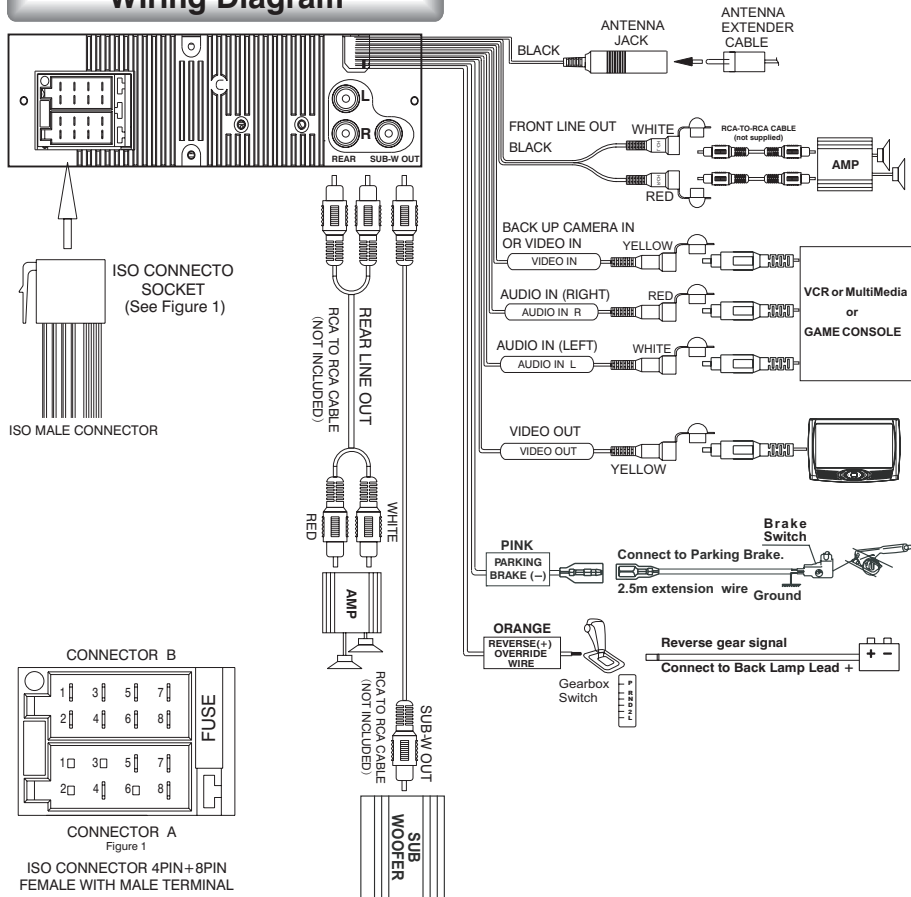

ISO CONNECTOR WIRING CHART





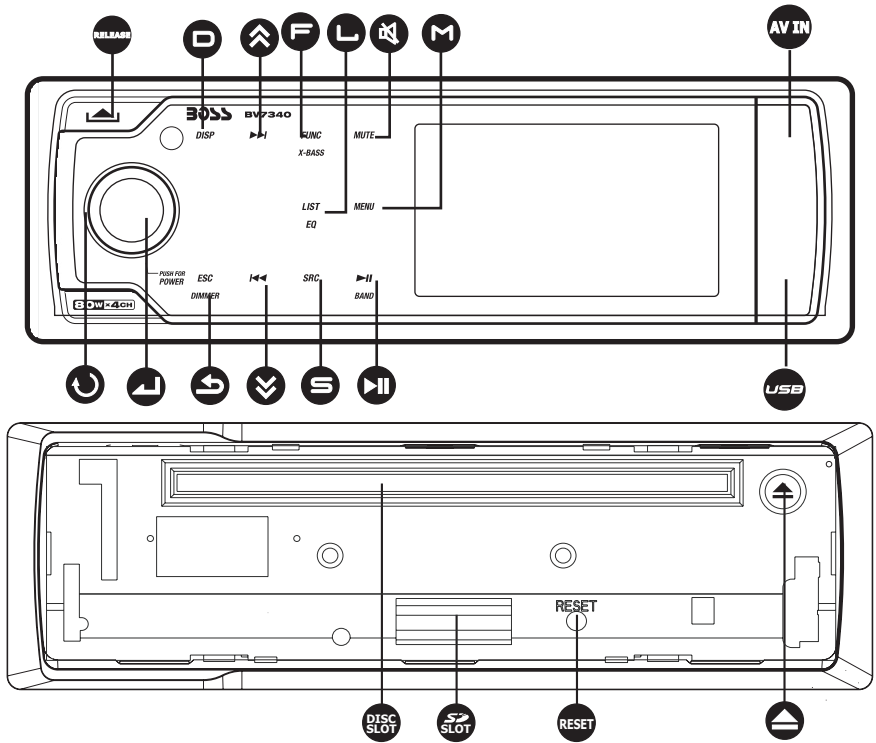









PIN	WIRE COLOR	FUNCTION/LABEL
A4	YELLOW	BATTERY(+)
A5	BLUE	POWER ANTENNA
A7	RED	IGNITION(ACC)
A8	BLACK	GROUND
B1	VIOLET	RIGHT REAR SPEAKER (+)
B2	VIOLET/BLACK	RIGHT REAR SPEAKER (-)
B3	GREY	RIGHT FRONT SPEAKER (+)
B4	GREY/BLACK	RIGHT FRONT SPEAKER (-)
B5	WHITE	LEFT FRONT SPEAKER (+)
B6	WHITE/BLACK	LEFT FRONT SPEAKER (-)
B7	GREEN	LEFT REAR SPEAKER (+)
B8	GREEN/BLACK	LEFT REAR SPEAKER (-)

THE FUNCTIONS OF MAIN UNIT



No.	Item	Descriptions
	RELEASE	▶ Press this button to open the control panel.
	AUDIO MENU	▶ Short press this button to access into the Audio Menu mode.
	POWER	▶ Press this button or any other button on the front panel (except Release button) to turn the unit on. Hold & press this button again to turn the unit off.
	ENCODER VOLUME KNOB	▶ Rotate the Encoder Volume Knob to increase and decrease the volume. (The Maximum volume level is "46".)
	BAND	▶ Under Tuner mode, short press this button to change between BAND FM1, FM2, FM3, AM1(MW1) (or AM2 (MW2) if available).
	▶▶ (PLAY/PAUSE)	▶ Under Media playback mode, short press this button to Pause/Resume Play the music.
	FUNC (FUNCTION)	▶ Press this button to enter into the Function mode.
	XBS	▶ Hold & press this button to turn On/Off the Bass booster function.

THE FUNCTIONS OF MAIN UNIT





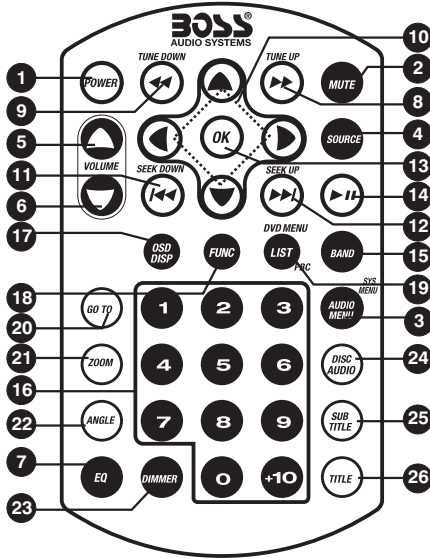











	DISP (DISPLAY)	▶ Under Media playback mode, short press this button to switch between OSD display or Video display mode.
	MUTE	▶ Short press this button to turn the Mute On/Off.
	LIST	▶ Under tuner mode, press this button to Show The List of stored station. ▶ Under the Media playback mode, press this button to list the searching of Tracks or Files on the Media playback mode. ▶ Under the MultiMedia/MP4 mode, press this button to list the searching of MultiMedia Root Menu or Files on the playback mode. ▶ Under the VCD mode, press this button to turn On/Off the PCB function.
	EQ	▶ Hold & press this button to select the preset Equalizer setting: OFF -> ROCK -> POP -> JAZZ -> TECHNO -> CLASSIC
	TUNE UP/DOWN	▶ Under tuner mode, press and hold this button momentarily to enter into the Auto Seek/ Manual Seek mode.
	FILE UP/DOWN	▶ Under media playback mode, press these buttons to skip a chapter / track / scene / file.
	FAST BACKWARD / FORWARD	▶ Under media playback mode, press and hold momentarily to fast forward / backward the Disc.
	SOURCE	▶ Press this button to select different source playback mode: TUNER / DISC / USB / SD / AV IN MODE
	↶ (ESC)	▶ Press this button to quick return previous menu or mode.
	DIM	▶ Hold & press this button to adjust the TFT dimmer High or Low.
	MENU (SYSTEM MENU)	▶ Press this button to access into the System Menu mode.
	EJECT	▶ Press this button to eject the Disc.
	DISC SLOT	▶ Insert the disc into CD slot. The CD will begin to play.
	RESET	▶ User can reset the unit to its default setting. Press this button by using a ball-point pen or sharp object.
	SD CARD SLOT	▶ This unit can support playback MP3/WMA/JPEG/MPEG4/ DIVX format which are stored on the SD Card.
	USB SLOT (The USB slot behind the USB/AV-IN jack door.)	▶ This unit can support playback MP3/WMA/JPEG/MPEG4/ DIVX format which are stored on the USB memory stick.
	AV-IN JACK (The AV-IN slot behind the USB/AV-IN jack door.)	▶ This unit is allowed to connect with external Audio/Video system such like Digital Camera or Game Console. User can connect the external A/V system thru the A/V in jack on front panel.

THE FUNCTIONS OF REMOTE CONTROL



No.	Button	Item	Decriptions
1		POWER ON OFF	Press this button to turn On / Off the unit.
2		MUTE	Press this button to turn the Mute On / Off.
3		AUDIO MENU	Press this button to enter into the Audio Menu mode.
		SYSTEM MENU	Hold & press this button to enter into the System Menu mode.
4		SOURCE	Press this button to enter into the SOURCE mode.
5		VOLUME +	Press this button to increase the volume.
6		VOLUME -	Press this button to decrease the volume.
7		EQ	Press this button to enter into the preset Equalizer setting mode.
8			Under the tuner mode, press this button to access the Manual Seek mode. Under the media playback mode, press this button fast forward through the music under media player mode.
9			Under the tuner mode, press this button to access the Manual Seek mode. Under the media playback mode, press this button fast backward through the music under media player mode.
10		UP/DOWN LEFT/RIGHT	Use these buttons to move cursor up/down/left/right.

THE FUNCTIONS OF REMOTE CONTROL

11		◀◀	Under the tuner mode, press this button access Auto Seek mode. Under the media playback mode, press this button to skip backward of the previous chapter.
12		▶▶	Under the tuner mode, press this button access Auto Seek mode. Under the media playback mode, press this button to skip forward of the next chapter.
13		ENTER/OK	Use this button to confirm the selection.
14		PLAY/PAUSE	Press this button to Pause / Resume Play the music under media playback mode.
15		BAND	Press this button to return previous menu. Under the tuner mode, press this button to change the radio Band.
16		NUMERIC BUTTONS	When in media playback mode use this button for track or file number direct access and use when function need numeric selection or input.
17		OSD DISPLAY	Press OSD button and the information displayed on the TFT may vary according to this disc or files type.
18		FUNCTION	Press this button to enter into the function mode.
19		LIST	Under tuner mode, press this button to Show The List of stored station. Under the Media playback mode, press this button to list the searching of Tracks or Files on the Media playback mode. Under the MultiMedia/MP4 mode, press this button to list the searching of MultiMedia Root Menu or Files on the playback mode. Under the VCD mode, press this button to turn On/Off thePCB function.
20		GOTO	Under the MP3/WMA mode, press this button to direct playback time. Under the MultiMedia mode, press this button to direct Title/Chapter / Time selection.
21		ZOOM	When playback the MultiMedia, press this button repeatedly to increase the magnification level.
22		ANGLE	Under MultiMedia mode, press this button while playing a scene recorded with multiple angles to change the angle.
23		DIMMER	Press this button to adjust the TFT dimmer High or Low.
24		DISC AUDIO	Under MultiMedia mode, press this button during playback to change the audio language, if available on the disc.
25		SUBTITLE	Under MultiMedia mode, press this button during playback to turn on/off subtitles and change the subtitles.
26		TITLE	Under MultiMedia mode, press this button to bring up the Title Menu.

ADJUST AUDIO SETTINGS

Press  Button to access the Audio Menu.
The below Audio Setting can be select:

▶ **BASS (Bass Level)**

User has 5 seconds to use the  to adjust the desired Bass level range from -6 to +6.

▶ **TREBLE (Treble Level)**

User has 5 seconds to use the  to adjust the desired Treble level range from -6 to +6.

▶ **BALANCE**

User has 5 seconds to use the  to adjust the Balance between the right and left speakers from R12 (full right) to L12 (full left).
“C00” represents an equal balance between the right and left speakers.

▶ **FADER**





User has 5 seconds to use the  to adjust the Fader between the front and rear speakers from R12 (full rear) to F12(full front).“C00” represents an equal balance between the front and rear speakers.

▶ **SUB-W (Subwoofer)**

Turn the  to select the Subwoofer function ON / OFF.

ADJUST SYSTEM MENU SETTINGS

► [M] MENU (System Menu)

Hold & press the  Button to get into the System Menu. User can use   to navigate thru the menu setting & rotate  to adjust the setting.

DIMMER

Turn the  to adjust the TFT Backlight level between High or Low.

BACK COLOR (Background)

This option allows the user to select the nine colors for the Background of the TFT screen. User can turn the  to select from the below colors:

WHITE / BLACK / GRAY / BLUE / CYAN / YELLOW / RED / PURPLE / GREEN

TITLE COLOR

This option allows the user to select the seven colors for the Title of the TFT screen. User can turn the  to select from the below colors:

RED / PURPLE / GREEN / GRAY / BLUE / CYAN / YELLOW

FONT COLOR

This option allows the user to select the 8 colors of the fonts of the TFT screen. User can use the  to select the below colors:

RED / BLUE / GRAY / CYAN / WHITE / YELLOW / PURPLE / GREEN

BEEP TONE

The beep tone feature allows the selection of an audible beep tone to be heard each time a button is pressed on the face of the radio. "BEEP TONE ON" is the default display. Rotate the  to select the "BEEP TONE OFF" option.

VOLUME PGM (Programmable Turn-on Volume)

This option allows the adjustment of the volume level of the radio will automatically assume when turning on. To program a specific turn on volume level, use the  to select "VOLUME LEVEL" level from 00 to 46.

TIME SET (CLK)

The time on the clock will be set to 12:00 as the default. Program the current time by rotating the  clockwise to adjust the minutes and counterclockwise to adjust the hours.

TIME FORMAT

"12H" is the default setting. User can use the  to choose the Time Format between "12 Hours" & "24 Hours"

DATE SET

Once in Date Set mode, User can use the  to adjust the Date / Month / Year. Short press the AUDIO button to confirm the entry and move to the next entry.

INFO (Software Information)

This is for displayed the software information of this unit.

TUNER OPERATIONS

▶ [F] FUNCTION BUTTON

Press the  Button under Tuner mode, the below functions are available for Tuner mode:

MANUAL STORE	Use this function to save the current frequency to memory station.
AUTO STORE	After Auto Store & saved the 6 strongest stations, the unit will automatically enter present scan one time.
LOCAL SEEK	This feature is used to designate the strength of the signals at which the radio will stop during automatic tuning. "Distance" is the default, allowing the radio to stop at a broader range of signals. To set the unit to select only strong local stations during automatic tuning, press the volume control to select the local ON/OFF.
AF ON/OFF	To change AF in ON or OFF mode.
TA ON/OFF	To change TA in ON or OFF mode.
PTY	You can get into the PTY list to select the desired PTY mode.
TUNER AREA	This option allows the selection of the frequency spacing which is most appropriate for the area this unit is used in, U.S.A, EUROPE

NOTE

AF, TA & PTY only appearing in the function list, after changed the Tuner Area to "Europe".

▶ BAND BUTTON

Press the BAND button to change between FM bands and or AM(MW) bands.

▶ [L] LIST BUTTON

Press  Button to get into the Presetted stations list, and user can use the  to select which presetted station he would listen to, and press  button to confirm the selection.

▶ [^][v] TUNING UP/DOWN BUTTON

1. Long press these buttons to access into the Manual Seek mode.
2. Press these buttons to access into the Auto Seek mode, and the unit will auto search for the next radio station.

ABOUT RDS

NOTE

This unit default at USA Tuner Area. RDS function only activated after selected the Tuner Area to "Europe".

TIPS

Please refer Tuner operation "FUNCTION" for details how to select the Tuner Area.

The RDS (Radio Data System) function operate only in areas with FM stations broadcasting RDS signals. If you tune to an RDS station, an RDS icon, presenter, and station/program information is displayed.

This unit support below RDS features:

▶ **PTY (Program Type)**

Before tuning to RDS stations, you can select program type and let the unit search only for programs of the selected category.

MUSIC GROUP	SPEECH GROUP
POP M , ROCK M	NEWS, AFFAIRS, INFO
EASY M, LIGHT M	SPORT, EDUCATE, DRAMA
CLASSICS, OTHER M	CULTURE, SCIENCE, VARIED
JAZZ, COUNTRY	WEATHER, FINANCE, CHILDREN
NATION M, OLDIES	SOCIAL, RELIGION, PHONE IN
FOLK M, TEST, ALARM	TRAVEL, LEISURE, DOCUMENT

▶ **AF (Alternate Frequencies)**

If the radio signal coming from the current station is poor, you can turn on the AF (Alternate Frequency) function to let the unit search for another station with stronger signal, but with the same program identification as the current station automatically.

▶ **TA (Receive Traffic Announcement)**

If you do not want to miss traffic announcement during enjoying music, you can turn on the TA (Traffic Announcement) function.

TA On When there is traffic announcement, the unit switches to the tuner mode (regardless of the current mode) and begins to broadcast the announcement on traffic conditions. When the traffic announcement is over, it returns to the previous mode.

TA Off Traffic announcement does not cut in.

▶ **CT (Clock Time)**

The RDS signal broadcast together with the clock time to the unit automatically.

MEDIA PLAYER OPERATIONS (Disc/USB/SD Card)

General Operation

[S] SOURCE BUTTON

Press **S** button to select DISC, USB, SD CARD. The unit will automatically start playback.

[▶||] PLAY/PAUSE BUTTON

Press **▶||** button to pause the music. Press this button again to resume play.

[F] FUNCTION BUTTON

Under the Function menu, user can have the below options for selection:

REPEAT	<ul style="list-style-type: none"> • ONE: play the current track repeatedly. • ALL: play all tracks repeatedly • ALBUM: play all tracks in the current folder repeatedly
RANDOM	During the disc playback, select random "On" to play all tracks on a CD in random order, select random "Off" will stop the random play.

[L] LIST SETTING

Under the Media playback, press this button access into File List Search mode.

File Searching

User can rotate the **⤵** to navigate thru the file list within the 10 sec time out. Press the Audio button to confirm to start play, or to open a selected Folder.



Album Up

Under List Search mode, press Track Up/Down as folder up/down on the unit.



[D] DISPLAY BUTTON

This DISPLAY interchange button can be used to interchange between the two types of DISPLAY INTERFACE, the 'OSD Display Interface' & 'Media Playback Display interface'. This is useful when playing a CD or MP3 or WMA or other music disc and if the user prefers to see the CD Track No/MP3 File number and elapse time with bigger numerical fonts, the Media Playback Display offers a better read out for the numerical display. User can press the **D** button to interchange from OSD Display Interface to Media Playback Display Interface.



OSD Display Interface



Media Playback Display Interface

MEDIA PLAYER OPERATIONS (Disc/USB/SD Card)

▶ [▲][▼] TRACK/FILE SELECT

Use TRACK/FILE UP (▲) or TRACK/FILE DOWN (▼) button to move to the next track on the Disc mode. The selected track number will appear on the display. Press and hold the button for more than one second to fast forward or fast rewind through the media. Media playback mode will resume to normal play when the button is released.

Insert the USB Stick

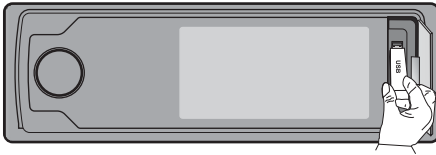

▲ CAUTION

This unit does not support any portable Hard disk / drive.

WARNING

Before removing the USB stick from the front panel, always remember to switch off the unit's power or switch to other mode then remove the USB Stick. Never try to remove the USB Stick while it is in use. It may damage the USB Stick, may cause permanent damage to the unit and/or cause the unit system to freeze.

Insert the SD Card

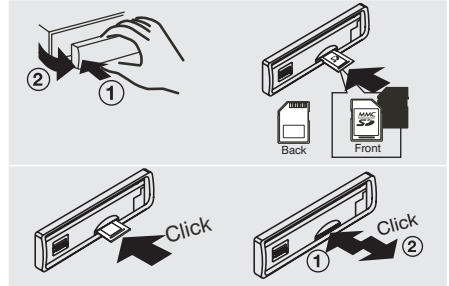

▶ Mode Change to SD Card

After an SD card is inserted into the main unit card slot, press the **S** Button to select card mode. The unit will start playing the files contained on the SD card. Once the unit starts reading the SD card successfully, the first file on the SD card will automatically start playback.

MULTIMEDIA OPERATION

Once a MultiMedia disc is inserted into the unit, the unit will automatically start the playback from the beginning of the disc, and then the MultiMedia MENU or ROOT or TITLE in the MultiMedia disc will appear on the TFT monitor and "ROOT" will be displayed on the TFT of the unit.

TIPS

When the MultiMedia MENU, ROOT or TITLE is displayed on the TFT Monitor, rotate the Encoder Volume Knob to navigate thru the file list. Press the Audio button to open the folder and start playback.

▶ [⏸] PLAY/PAUSE BUTTON

1. Press this button to pause playback.
2. Press this button again to resume normal playback.

▶ [D] DISPLAY BUTTON

This DISPLAY interchange button can be used to interchange between the two types of DISPLAY INTERFACE, the 'OSD Display Interface' & 'Media Playback Display interface'. This is useful when playing a CD, MP3, WMA or other music discs. If the user prefers to see the CD Track No/MP3 File number and elapse time with bigger numerical fonts, the Media Playback Display offers a better read out for the numerical display. User can press  button to interchange from OSD Display Interface to Media Playback Display Interface.

DISC

T01 C13 DVD
00 : 30 : 18

15-APR-09 18:09

OSD Display Interface



Media Playback Display Interface

▶ [L] LIST BUTTON

Under the MultiMedia playback mode,  button can access to the MultiMedia Root menu.

▶ [⏭][⏮] TRACK SELECT

1. Press these buttons to skip forward to the beginning of the next or previous chapter.
2. Long press these buttons to fast forward or fast rewind through the disc. Press these buttons again to resume normal playback.

▶ [F] FUNCTION BUTTON

Under the Function menu, user can have the below options for selection:

REPEAT	<ol style="list-style-type: none"> 1. Repeat "CH" to repeat playback the current the chapter. 2. Repeat "TITLE" to repeat playback the current title. 3. Repeat " OFF" to cancel all the Repeat function.
MultiMedia AUDIO	During playback to change the audio language(MultiMedia/Divx only).
VIDEO SETTING	<p>Under the Video Setting mode, there are have below options for selection:</p> <ul style="list-style-type: none"> ● BRIGHT: to adjust the TFT Bright level from "01" to "09"; ● CONTRAST: to adjust the TFT Contrast level from "01" to "09"; ● COLOR: to adjust the TFT Color level from "01" to "09"; ● DEFAULT: setting the Default on will reset all options of media function setting to factory default setting.
ASPECT RADIO	<p>Selecting the TV Aspect setting allows the user to select the aspect ratio of the TV (MultiMedia and VCD only). The following options are available:</p> <p>4:3 = Aspect ratio of TV is 4:3. 16:9=Aspect ratio of TV is 16:9. Both wide screen and 4:3 contents will fill the entire screen.</p>

AV-In Mode



Select the AV Mode

You can connect up to 1 AV device, press  Button to enter into the AV mode:
AV in - 1 = Front panel AV in (Optional)
AV in - 2 = RCA back of unit (Optional)

▶ AV in-1

This unit is allowed to connect with external Audio/Video system such like Digital Camera or Game Console. User can connect the external A/V system thru the A/V in jack on front panel.

▶ Connect the A/V In

Connect the external signal to A/V in jack located at the front of the panel, then press  Button to select A/V mode. Press  Button again to cancel A/V mode and return to previous mode.

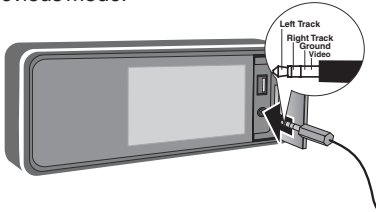

▶ AV in-2

Connect the external signal to the RCA line in jack located at the rear of the unit, then press  Button to select AV in-2.

TIPS

If there is no any external AV System input, then the TFT will be show "NO VIDEO SIGNAL".



SPECIFICATIONS

TFT Screen Section

Screen Size: 3.2" (Measured Diagonally)
Screen Type: TFT Liquid Crystal Display active matrix
Resolution: 320 x 240

MultiMedia / CD Section

Compatible Disc/Format	See " Disc Note" for more details description
Signal to Noise Ratio	≥ 90 dB
Dynamic Range	≥ 90 dB
Frequency Response	20Hz to 20Khz +/-3dB
Channel Separation	2 Channel (Stereo) >60dB @1khz

Video Section

Color System	NTSC / PAL/SCEAM
Video Output	Composite 1.0 Vp-p (+/- 0.2) 75 - ohm
Video Input	Composite 1.0 Vp-p (+/- 0.2) 75 - ohm

Audio Section

Max Output Power	80W x 4 channels
Load Impedance (speakers)	4 ohms
Line out level / load	400mV / 10k ohm load
Line out Impedance	200 ohm

Auxiliary Input Section

Frequency response	20Hz to 20KHz -3dB
Input Maximum Voltage	1200 mV
Input Impedance	4.7k ohm

Radio Section

FM

Frequency Range	87.5-108.0 MHz (Europe) 87.5-107.9 MHz (U.S.A)
Usable Sensitivity	≤ 15dB at S/N 30 dB
Stereo Separation	25 dB at 1 KHz
S/N Ratio	50 dB

AM or MW

Frequency Range	522-1620 Khz (Europe) 530-1720 (U.S.A)
Usable Sensitivity	≤ 40dB at S/N 20dB
S/N Ratio	40 dB

General

Operating Voltage	DC 11 -14.4V
Grounding System	Negative Ground
Fuse:	15-Amp Mini ATM Type
Operating Temperature:	0° C to 50° C
Unit Mounting Angle	≤ 30°

TROUBLESHOOTING

Before going through the check list, check wiring connection. If any of the problems persist after check list has been made, consult your nearest service dealer.

Symptom	Cause	Solution
No power	The car ignition is not on.	If the power supply is properly connected to the car accessory terminal, switch the ignition key to "ACC"
	The fuse is blown.	Replace the fuse.
Disc cannot be loaded or ejected	Presence of CD disc inside the player.	Remove the disc in the player, then put a new one.
	Inserting the disc in reverse direction.	Insert the compact disc with the label facing upward.
	Compact disc is extremely dirty or defective disc.	Clean the disc or try to play a new one.
	Temperature inside the car is too high.	Cool off or until the ambient temperature returns to normal.
	Condensation.	Leave the player to off for an hour or so, then try again.
No sound	Volume is in minimum.	Adjust volume to a desired level.
	Wiring is not properly connected.	Check wiring connection.
The operation keys do not work	The built-in microcomputer is not operating properly due to noise.	Press the RESET button. Front panel is not properly fixed into its place
Sound skips.	The installation angle is more than 30 degrees.	Adjust the installation angle to less than 30 degrees.
	The disc is extremely dirt or defective disc.	Clean the compact disc. Then try to play a new one.
The radio does not work. The radio station automatic selection does not work.	The antenna cable is not connected.	Insert the antenna cable firmly.
	The signals are too weak.	Select a station manually.
ERROR	Mechanism Error	Press the eject button to correct the problem. If the error code does not disappear, consult your nearest service dealer.
Disc Error	Maybe disc dirty / disc scratched /disc upside down.	Replace the disc.



If at any time in the future you should need to dispose of this product please note that Waste electrical products should not be disposed of with household waste. Please recycle where facilities exist. Check with your Local Authority or retailer for recycling advice.(Waste Electrical and Electronic Equipment Directive)