

ANZZI™

**MODEL
T1-AZ061**

INSTALL GUIDE



Certified by
IAPMO R&T



"Complies with ASME
A112.19.2-2013
"Conforme à ASME
A112.19.2-2013"

For more information visit us at www.ANZZI.com or call us at 1-844-44-ANZZI



- Please read these instructions carefully before starting installation and retain for future reference. Please leave these instructions with the end user.
- Remove all packaging and check the product for missing parts and damages before starting the installation.
- Any alterations made to this product and its fittings may infringe the water regulations and will invalidate the guarantee.
- We strongly recommend the use of a qualified and registered plumber.
- In new buildings it is recommended to water fill the traps to ensure toxic gases do not corrode the surface of the taps and toilet seats. It is recommended that the room is well ventilated.
- Thoroughly flush through all pipe work prior to the installation of terminal appliances, e.g. Shower heads, taps, inlet valves etc.
- Factory fitted components such as inlet and outlet valves should be checked for position and tightness, they may have loosened in transit. Check the operation of the valves.
- Periodic cleaning and maintenance should be used to avoid the build up of damaging lime scale deposits.
- Bathroom harsh cleaning agent residuals may damage some materials, such as seat hinges and plastic or chrome components.

- Lire attentivement cette notice avant de commencer l'installation
- Vérifier si certaines pièces sont manquantes o abîmées.
- Toute altération qui sera effectuée à la sanitaire rendra invalide la garantie.
- Nous recommandons fortement l'installation du produit par du personnel qualifié.
- Dans le cas de constructions neuves, il faut mettre en eau les WC, lavabos et bidets pour éviter que la robinetterie et les abattants ne s'oxydent ou ne jaunissent à cause de gaz corrosif. Nous recommandons de laisser un espace très aéré.
- Purger les tuyauteries avant l'installation.
- Vérifier le fonctionnement du mécanisme du réservoir du WC.
- Grâce à un entretien régulier, on peut éviter la formation de calcaire.
- Produits résiduels des toilettes et nettoyage peuvent abimer les pièces métalliques des sanitaires, comme les charnières et enjoliveurs.

- Lea atentamente estas instrucciones antes de comenzar la instalación.
- Compruebe el producto por si faltasen piezas o estuviesen dañadas.
- Cualquier alteración que se realice al sanitario invalidaría la garantía.
- Le recomendamos la instalación por parte de personal cualificado.
- En nuevas construcciones se deben llenar los sifones de inodoros, lavabos y bidets de agua para evitar que la grifería y los asientos se oxiden o amarilleen por el efecto de la subida de gases corrosivos. Se recomienda que el espacio esté muy aireado.
- Purgar las tuberías antes de la instalación.
- Compruebe el funcionamiento del mecanismo de la cisterna del inodoro.
- Gracias a un cuidado periódico se puede evitar la formación de restos calcáreos.
- Residuos de productos de aseo y limpieza pueden dañar las piezas metálicas de los sanitarios, como bisagras y embellecedores.

T1-AZ061 Specification Sheet and Dimensions.

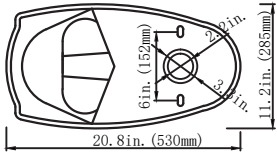
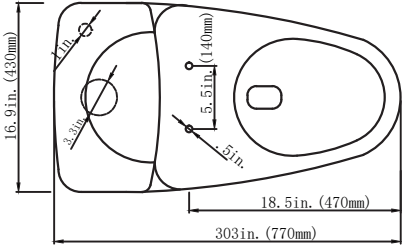
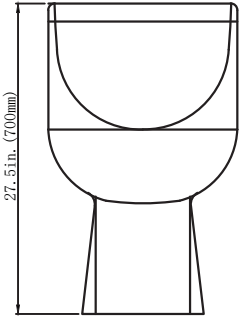
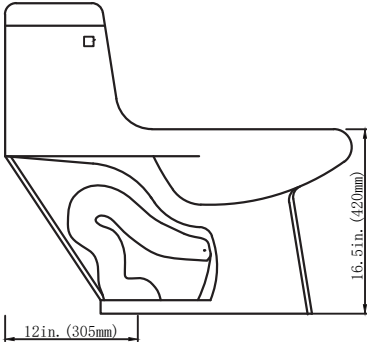

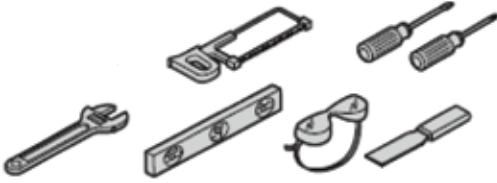

ATTENTION: INSTALLATION FITTINGS NOT INCLUDED.
 ATENCION: MATERIAL NECESARIO PARA LA INSTALACION NO INCLUIDO.
 ATTENTION: MATERIEL NECESSAIRE A L'INSTALLATION NON INCLUS.

1

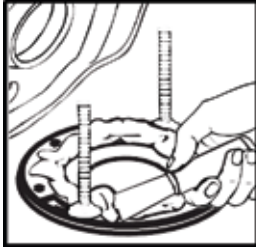

-If replacing a toilet, remove the old wax.
 -Si va a reemplazar el inodoro, quite la cera vieja.
 -En cas de remplacement du W.C., retirez l'ancienne cire.

2

-Install the floor screws.
 -Instale los tornillos de fijacion a suelo.
 -Installez les vis au sol.

3

Wax seal
 Sello de cera
 Joint en cire



4

-Do not move after placement! Watertight seal may be broken!
 -¡No mueva despues de colocar! ¡Se puede romper el sello hermético!
 -Ne pas bouger après avoir placé! Le joint d'étanchéité pourrait être casse !

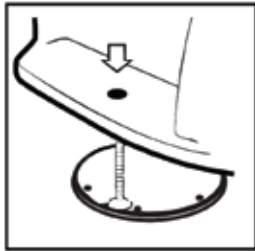

-Apply weight evenly.
 -Aplique peso uniformemente.
 -Appliquer du poids également.

5



-Block the WC. Do not overtighten.
 -Fijar el inodoro. No apriete demasiado.
 -Fixer le WC. Ne pas trop serrer



6

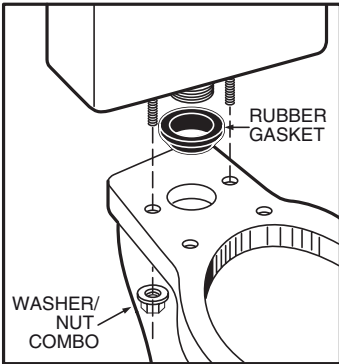

-Instale la junta cónica y el kit fijación cisterna como mostrado en la figura.

-Install the rubber gasket and fixing tank kit as show in the picture.

-Installez le joint en caoutchouc cône et le kit de fixation du réservoir comme montré dans l'image.

7

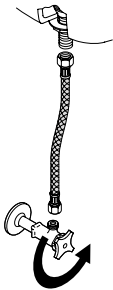

- Connect supply.
- Conecte el suministro.
- Connecter l'alimentation.

8

- Install the seat & cover
- Instalar el asiento
- Installez l'abattant

Flush several times and check for leaks.
Do not overtighten!

Accione la descarga varias veces y verifique que no haya fugas.
¡No apriete demasiado!

Purger plusieurs fois et vérifier s'il y a des fuites.
Ne pas trop serrer!



9

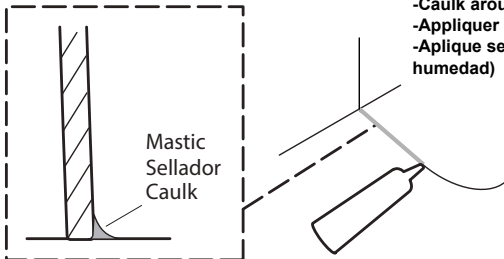

- Caulk around base (neutral anti-moisture silicone must be used)
- Appliquer du mastic autour de la base. (avec silicone neutre)
- Applique sellador en la base del inodoro (usar silicona neutra anti-humedad)