

# ASSEMBLY INSTRUCTION







ITEM: 6750-75500-37 Host Chair-2 per carton/price ea

Thank you for purchasing this quality product. Be sure to unpack carefully looking for small parts which may have come loose during shipment.

Read all instruction and study the drawing carefully before starting the assembly process .

**HARDWARE PACK**

**PART LIST**

NO.	DRAWING	DESCRIPTION	SIZE	Q'TY	NO.	DRAWING	DESCRIPTION	Q'TY
A		Bolt	5/16"	8PCS	①		Seat	1PC
B		Lock Washer	5/16"	8PCS	②		Front Leg	2PCS
C		Flat Washer	5/16"	8PCS	③		Back Leg	2PCS
D		Allen Wrench	73*29*5mm	1PC				

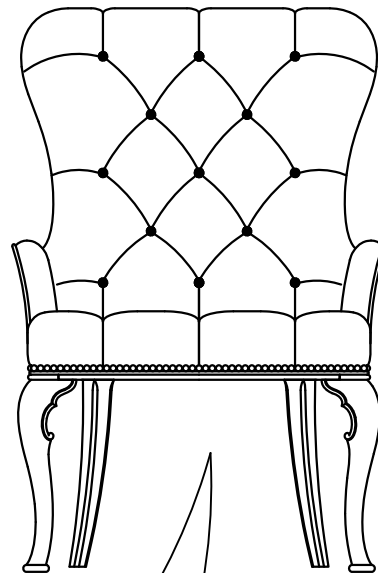

**STEP 1**

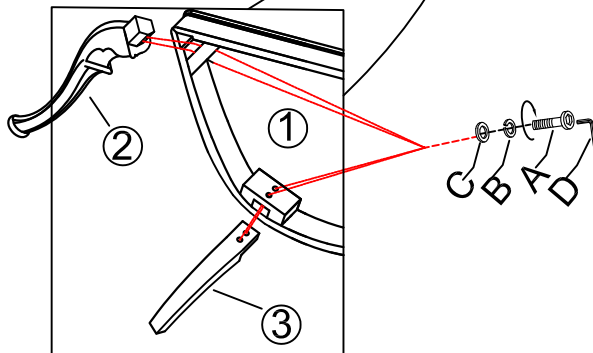

Thank you for purchasing this quality product. Be sure to unpack carefully looking for small parts which may have come loose during shipment.

Read all instruction and study the drawing carefully before starting the assembly process.

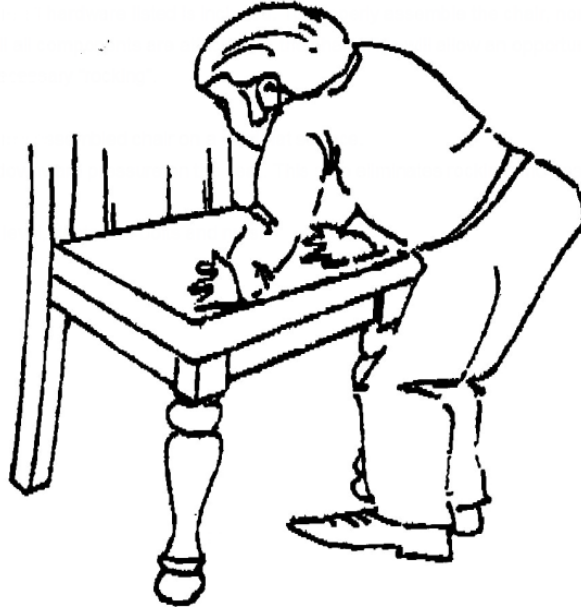

## **PLEASE READ THESE INSTRUCTIONS PRIOR TO ASSEMBLING THE CHAIRS CHAIR LEVELING INSTRUCTION SUPPLEMENT**

### **Chair leveling procedures:**

To make the assembly process easy and efficient, please read the entire instruction sheet prior to assembling of the chair. Make sure all hardware listed is included. To properly assemble the chair, none of the bolts should be fully tightened until all components are attached to the chair. This will allow an opportunity to level the chair and prevent any unnecessary “rocking”.

1. Place the loosely assembled chair on a hard flat surface.
2. Apply gentle downward pressure on the seat. This step eliminates rocking and ensures the chair to be level.
3. Once the chair is level, tighten all bolts and nuts.

### **Note:**

Most floors have slight irregularities that can affect chair leveling. If your chair is uneven when placed in its desired location, perform the following steps:

1. Loosen front legs to finger tight.
2. Extend both front legs upward to their fullest length.
3. Gently push downward on the front edge of the seat until all four legs rest on the floor.
4. Re-tighten all bolts and nuts.