

**VERSANORA**  
**Cara Tripod Floor Lamp**

VN-L00001  
VN-L00002  
VN-L00003

**TIME SAVER!**  
3D Interactive Instruction

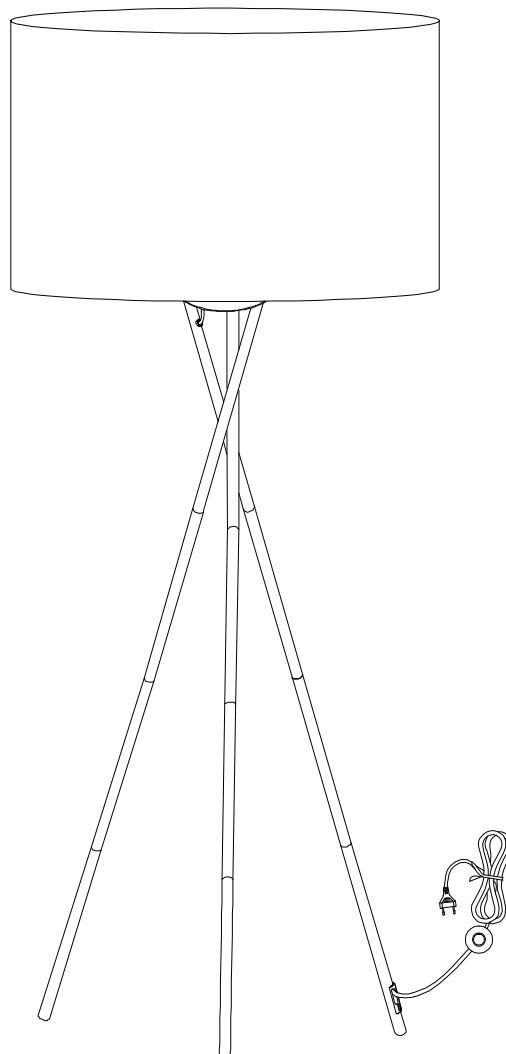

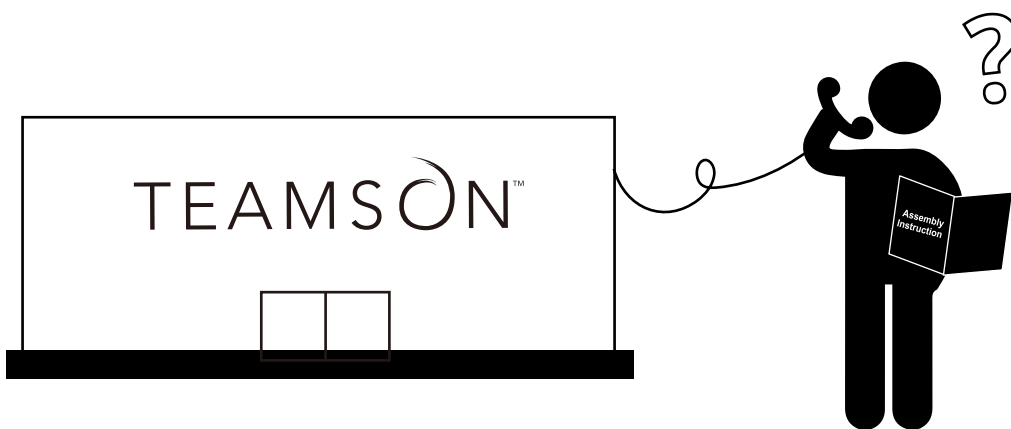
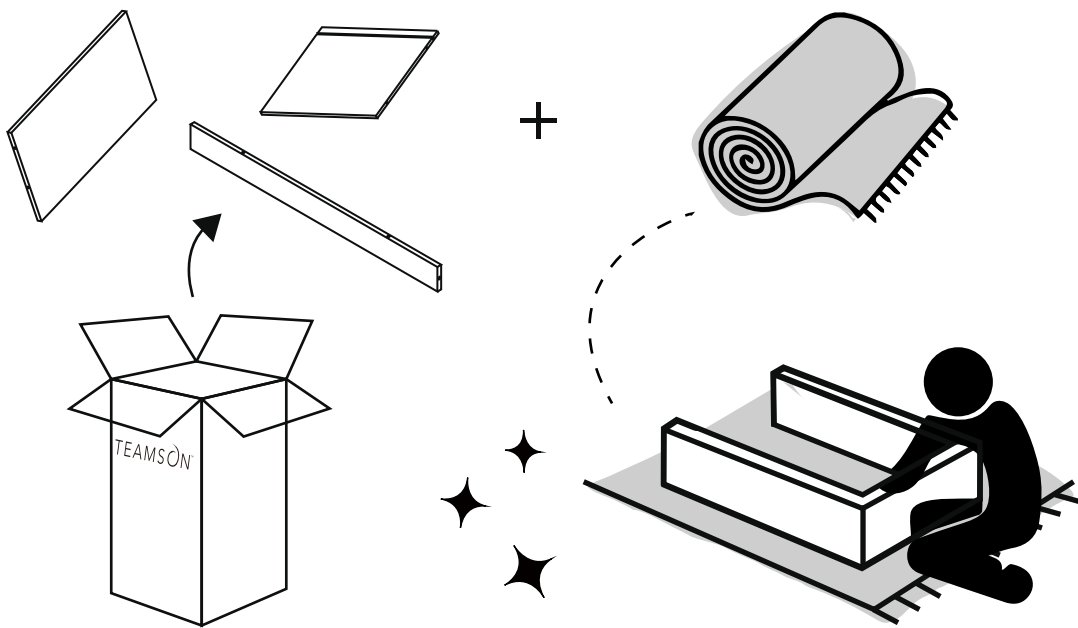
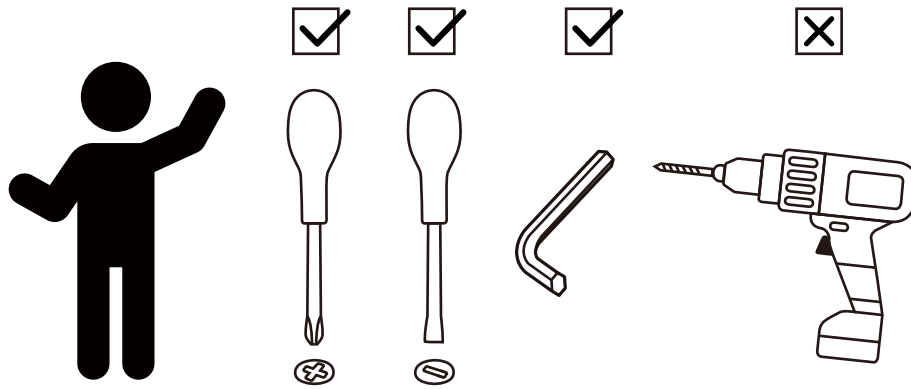

\*\* Got questions? Please have your product code (on the first page of this instruction, e.g. TD-12345A) and the order number ready, give us a call or email us through our customer care support! We are always ready to assist you!

# TEAMSON HOME



Warranty sign up

[www.teamsonhome.com](http://www.teamsonhome.com)

**Serving you well gives us great joy!**

**USA . . . . +1(800)935-3959**

Mon - Fri 10:00am ~ 2:00pm EST

✉ [support@teamson.com](mailto:support@teamson.com)

**EU . . . . . +44(0)1952-916-050**

Mon - Thu 9:00am ~ 5:00pm GMT

Friday 9:00am ~ 4:00pm GMT

✉ [support@teamson.co.uk](mailto:support@teamson.co.uk)

If the external flexible cable or cord of this luminaire is damaged, it shall be exclusively replaced by [teamson.uk](http://teamson.uk) or a similiar qualified person in order to avoid a hazard.

**ASIA . . .** 深圳办公室:

**+86(0755)8885-3558.分机号108**

Mon - Sat 9:00am ~ 5:00pm GMT+8

✉ [sales\\_ec@teamson.com](mailto:sales_ec@teamson.com)

台北辦公室:

**+886(2)2556-6268**

Mon - Fri 9:00am ~ 5:00pm GMT+8

✉ [sales\\_ec@teamson.com](mailto:sales_ec@teamson.com)

**Thank you for choosing Teamson Home**

# Exploded Drawing

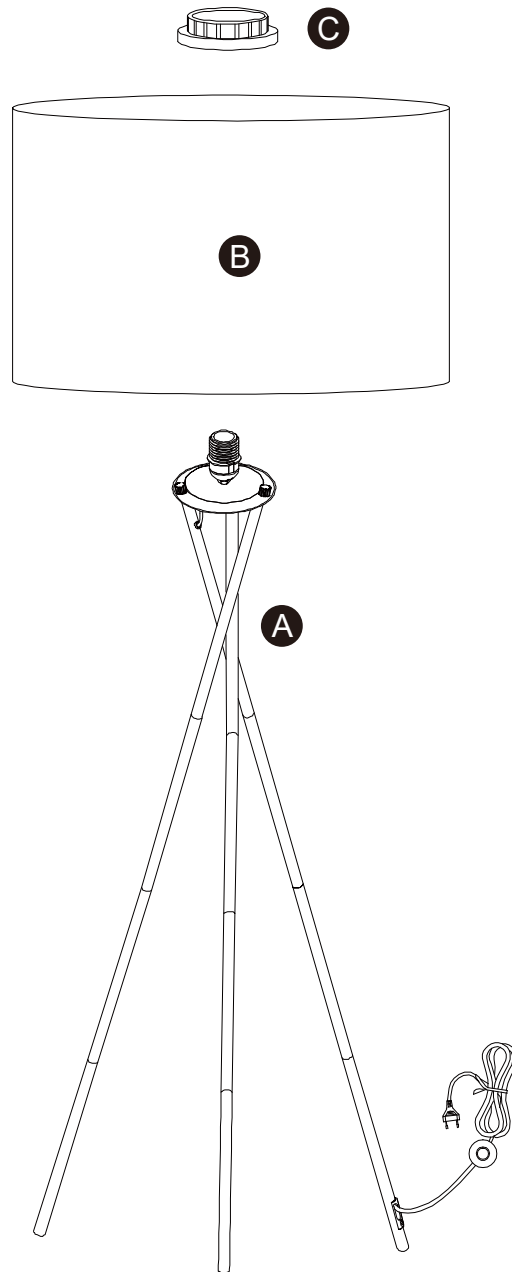

← **Questions?**  
Scan Here

## Product Parts

A



1 PC

B

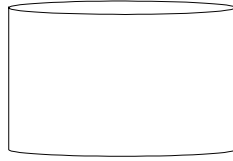

1 PC

C

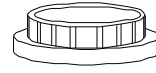

1 PC



**Questions?**  
Scan Here

### Care Instructions

Dust surface with a dry soft cloth.

Do not use window cleaners or cleaning abrasives as they will scratch the surface and could damage the protective coating

### WARNING

Small parts and sharp edges may be present prior to assembly.

Step 1

Step 2

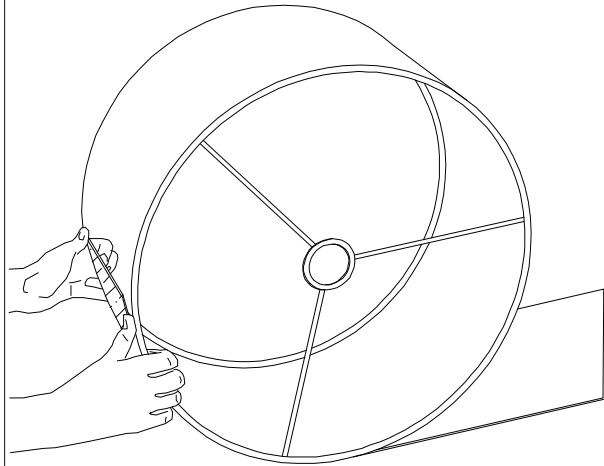
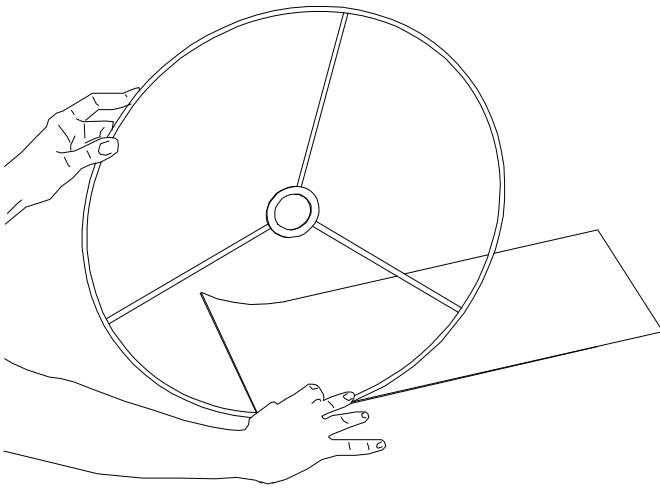

Step 3

Step 4

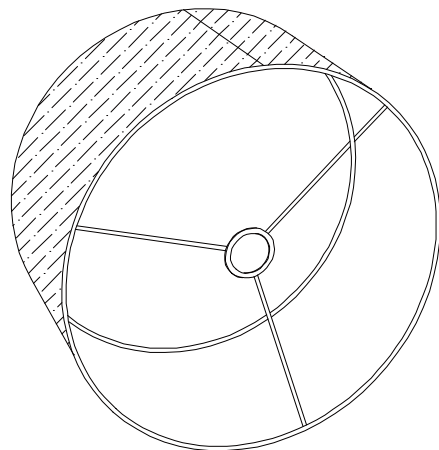
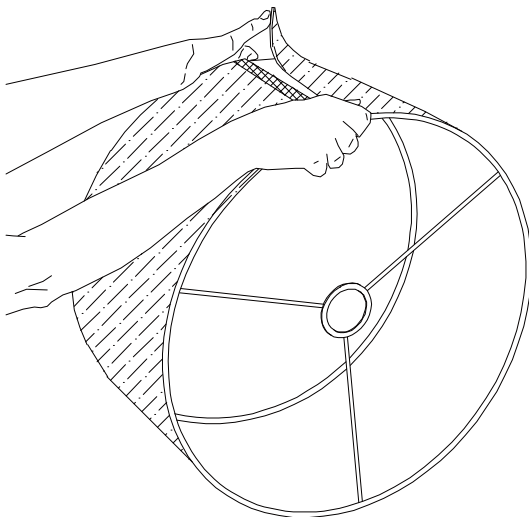

← **Questions?**  
Scan Here

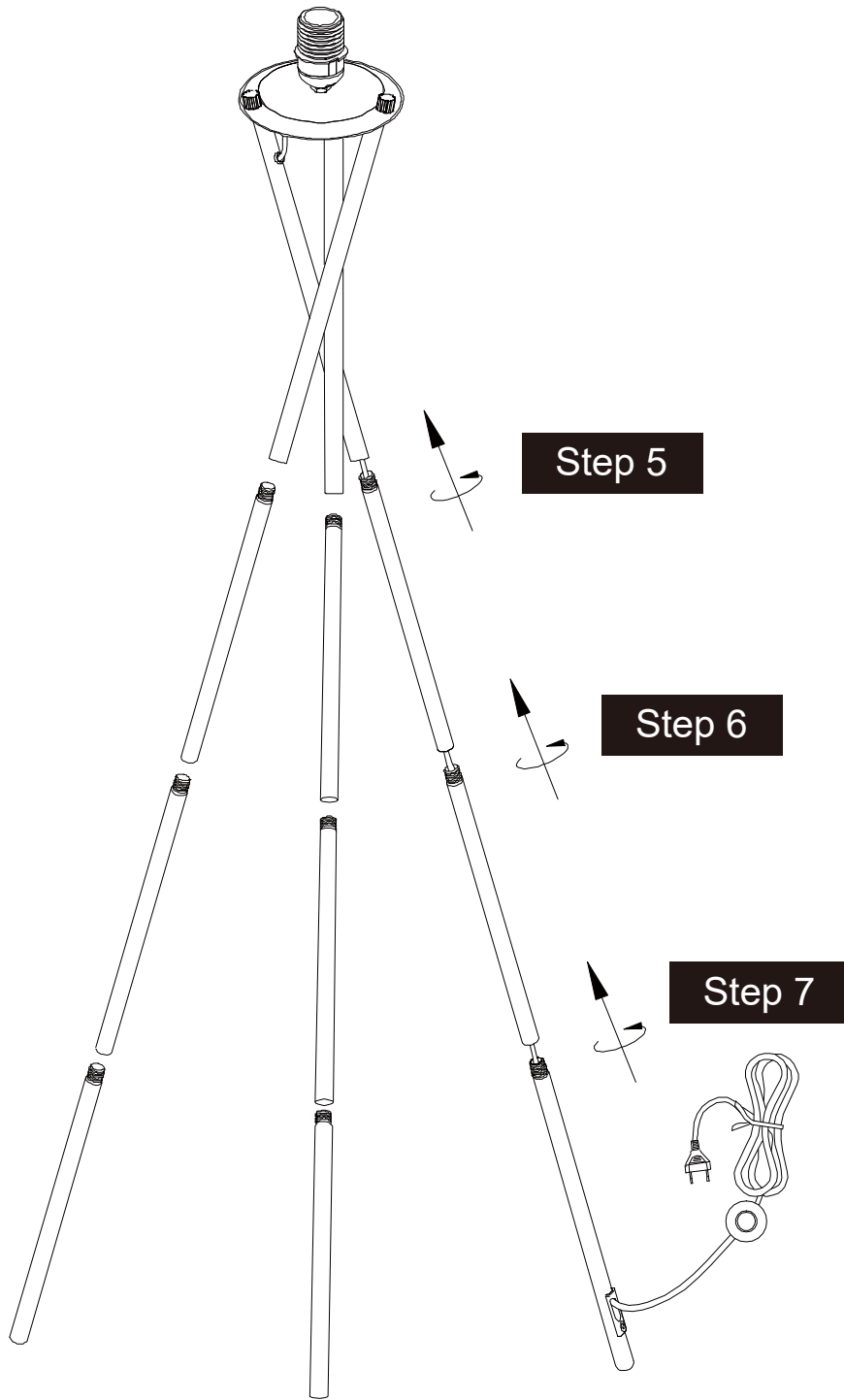

**Questions?**  
Scan Here

**Step 10**

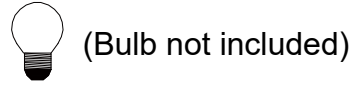

**Step 9**

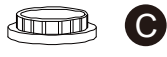

**Step 8**

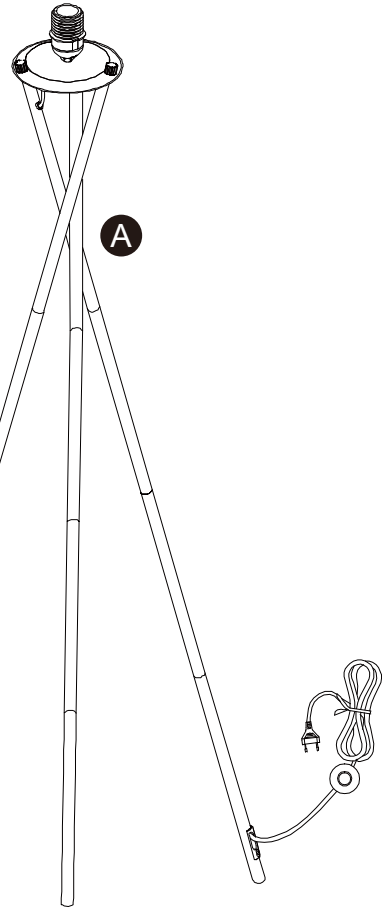
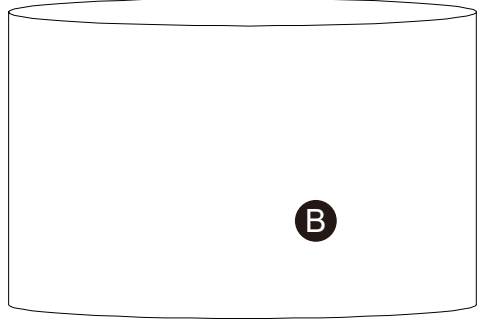

**Questions?**  
Scan Here