

Brand	AXOR
Art. Name	AXOR ShowerSolutions Showerhead 250 2- Jet with Showerarm Trim, 2.5 GPM
Art. Nr.	35296001
Surface	chrome
Pos.	1

Product Picture



Features

- Consists of: Showerhead, Showerarm, Green Diverter
- shower head size: 250 mm
- Spray modes: PowderRain, Intense PowderRain
- adjustment with shift on thermostat
- dynamic spray nozzles move out while using
- Flow: 2.5 GPM (9.5 L/Min)
- Showerhead removable for cleaning
- ServiceCard with sieve can be removed without tools for cleaning purpose

Drawing

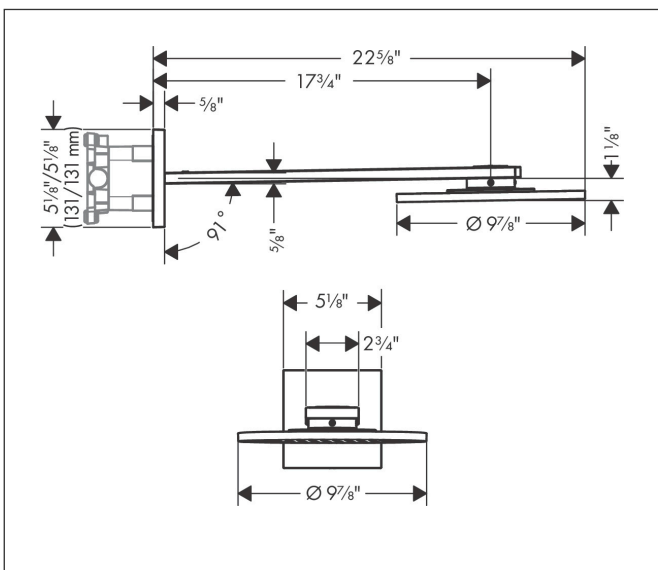

Technology



Spray Types

