

User's Manual

HIR9BGTM

**UNIVERSAL HEADREST
WITH PRE-INSTALLED
9" (229mm) WIDESCREEN
TFT VIDEO MONITOR**

HIR9BGTM

**UNIVERSAL HEADREST WITH
PRE-INSTALLED 9" (229mm)
WIDESCREEN TFT VIDEO MONITOR**

01.2012



tech support: www.bossaudio.com/support

BOSS[®]
AUDIO SYSTEMS

BOSS Audio Systems
3451 Lunar Court • Oxnard, CA 93030
www.bossaudio.com
800.999.1236

BOSS[®]
AUDIO SYSTEMS

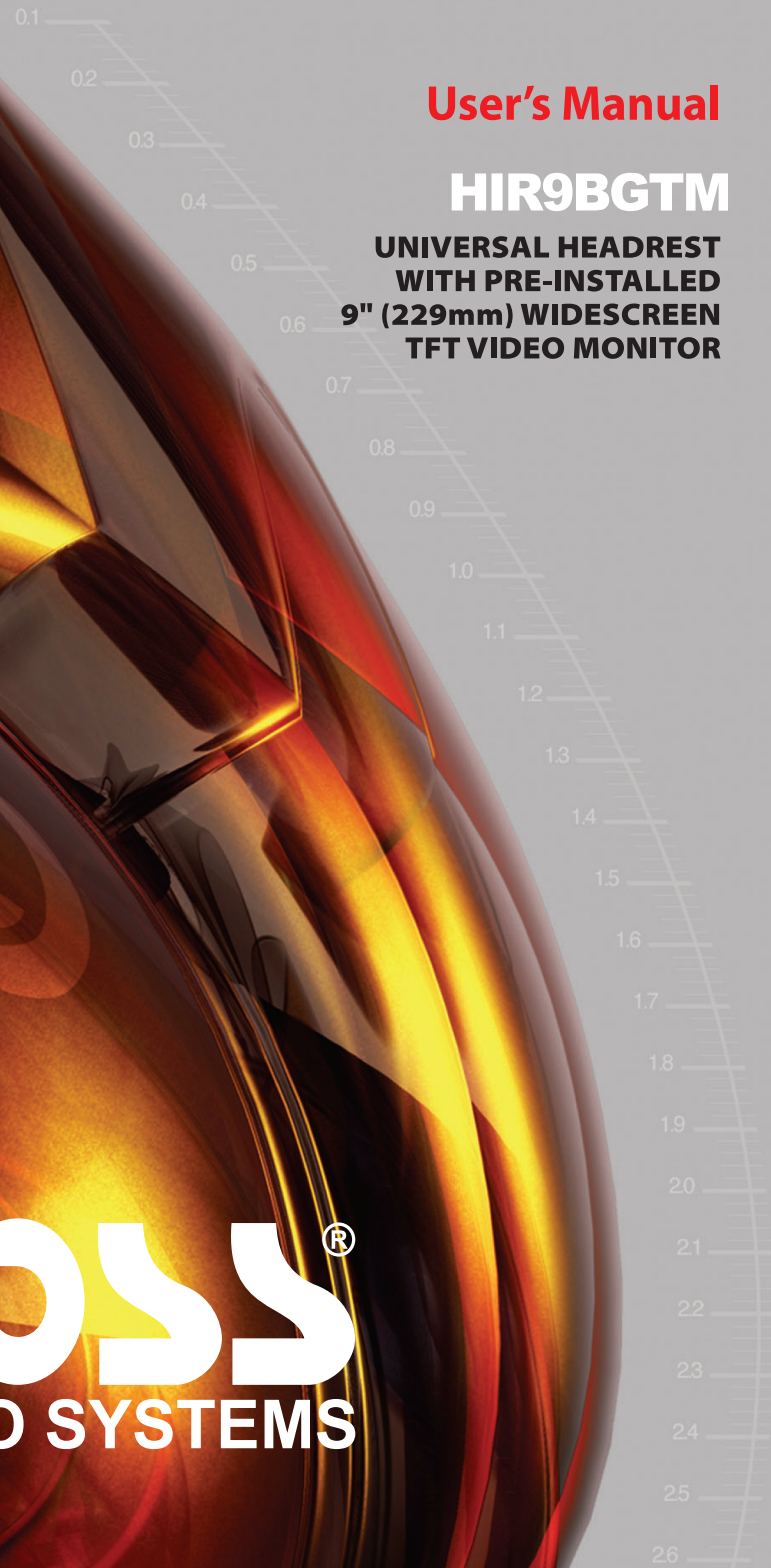

MONITOR CONTENTS

MONITOR Features	-----	1
Warnings	-----	2
Product Structure	-----	2
Structure	-----	3
Accessories	-----	3
Remote control	-----	4
OSD function	-----	4
Installation	-----	5
leather change instruction	-----	6

MONITOR Features :

- LED backlit panels for exceptional picture quality, high efficiency and long life
- Cover colors easily interchangeable between black, grey and tan to match vehicle interior (all 3 colors included)
- Pole distance adjustable from 4"-7" apart for universal fit
- Free tilt mechanism allows for adjustment to optimal viewing angle
- Automatically selects PAL/NTSC system
- Built-in front 3.5mm AV input jack
- Front 3.5mm jack for headphones
- 2 A/V inputs
 - One 3.5mm front input jack
 - One wired RCA input
- Wireless remote control
- Built-in dual-channel speaker
- Built-in dual channel IR transmitter
 - Ch A: 2.3MHz(left)-2.8MHz(right)
 - Ch B: 3.2MHz(left)-3.8MHz(right)
- 9"(16:9) TFT LCD display
- Resolution: 480(H) X 3(RGB) X 800(W)
- Number of Pixels:1,152,000
- Brightness: 400 cd/m²
- Power supply: DC +12V (10.6V-15.8V)
- Power consumption: 12W
- Operating temperature:-10°C to +60°C
- Dimensions: 11" x 6" x 14 ¾"
- Weight: 5 lbs.

Warning

- ▶ Read this manual before using this product.
- ▶ This product is composed of precision components and shall not be disassembled
- ▶ Protect the product from moisture and shock

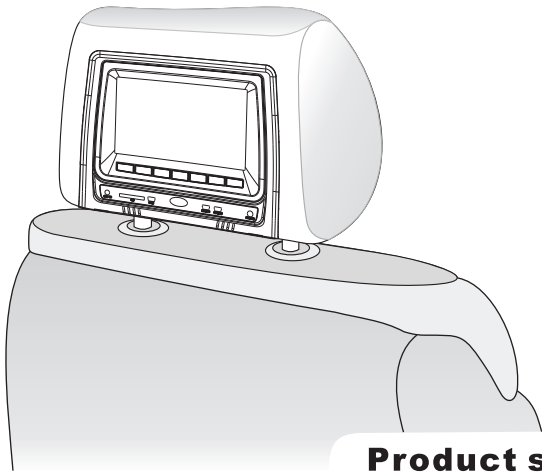

Product structure

“Thank you for your purchase of our mobile video product. To ensure long-term trouble free operation of the product, please read the following operations manual before using the monitor. To further ensure the long-term service of your product, please have one of our authorized dealers to install this product into your vehicle for you.”

leather change instruction



STEP 7: Slide on the edges of the leather cover from left to right.

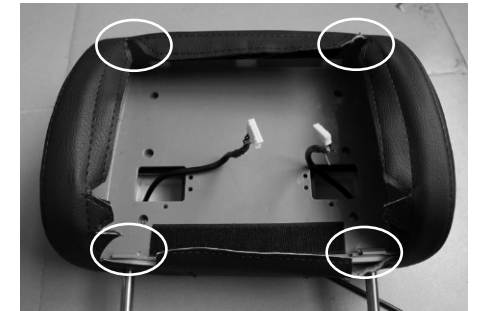

STEP 8: Make sure the leather covers all headrest cushion areas after the cover is set in place.



STEP 9: Secure all the edges of leather cover by pressing firmly on the Velcro areas.



STEP 10: Connect the two cables and reassemble.

leather change instruction



STEP 1: Press the two buttons on the bottom of the headrest firmly.



STEP 2: Disconnect the connecting cables.

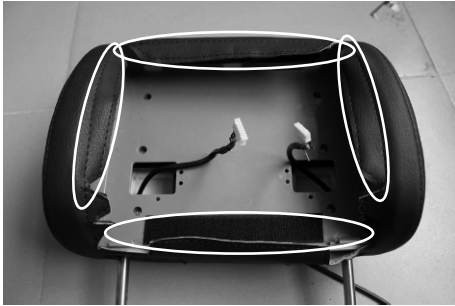

STEP 3: Pull out the 4 edges of the leather cover held by Velcro.

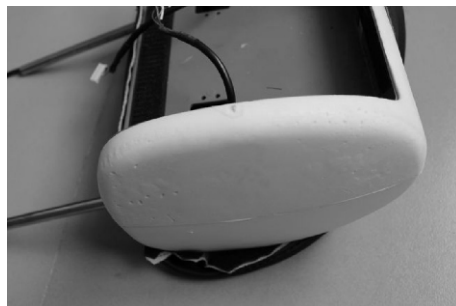

STEP 4: Once the edges are loosen, remove the leather cover beginning on one end and moving on to the other.



STEP 5: Flip the new desired leather cover inside out.



STEP 6: Slide the 2 metal poles through the two openings on the reversed leather cover.

Structure

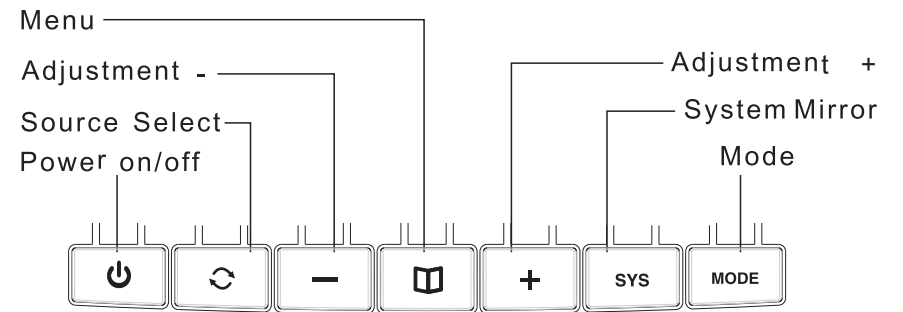
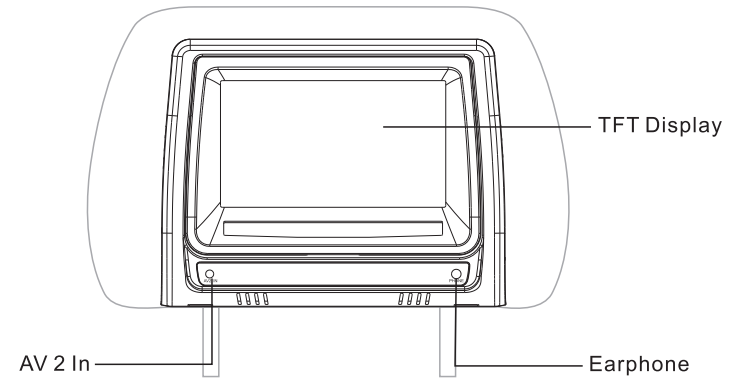

ACCESSORIES

Description	Quantity
1. Power Cable	1PC
2. Pole Diameter Spacers	2PCS
3. Remote Control	1PC
4. Users Manual	1PC

Connection Method

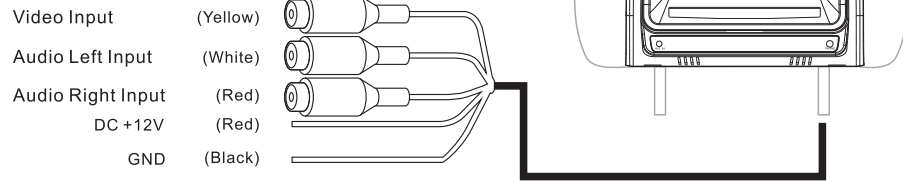

Remote control

1. Power On/Off
2. AV1, AV2 Switch
3. Adjustment+
4. Exit
5. Menu
6. Adjustment-



OSD function

The following menus will appear when pressing “MENU” button, press “←” “→” to select the one you want.

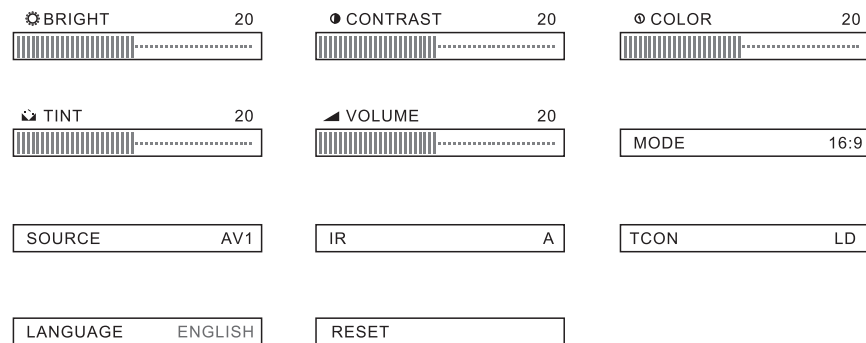

Install the pillow

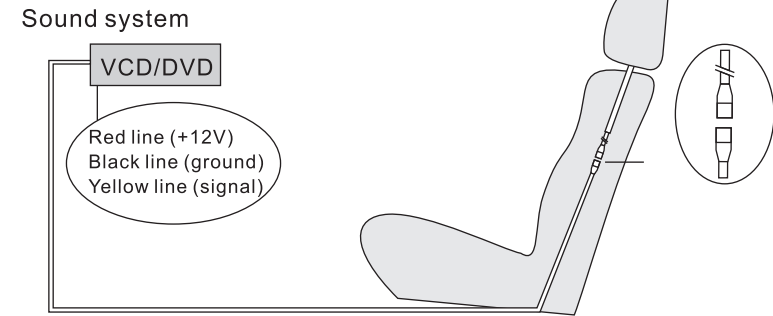

The circuit connection of the headrest monitor is very simple. As shown in Fig. Connect the +12V power of the sound system (red line to +, black line to ground), and then connect the A/V input. Hide the connection in the base of seat.

Installation

1. Remove the original headrest in the car.
2. Install the headrest monitor. Adjust the steel tube in or out (max. interval: 8inch; min interval: 4 inch) according to the interval between pillow holes so that the interval between steel tubes of the pillow monitor coincides with that between steel tubes of the original pillow headrest.

