



COMMERCIAL *ELECTRIC* FOOD WARMER , 4/3rd Size

Operating Instruction Manual



FW-L600



Model	Voltage ~ Hz	Power (W)	Amperage	Power Cord	Dimensions - Overall			
					Length	Width	Height	
FW-L600	120V ~ 50/60Hz	1500W	12.5A	15A	29-3/4" (755mm)	14-5/8" (370mm)	10-11/16" (270mm)	
				Plug Type		Well Opening		
				NEMA 5-15P	27" (658mm)	11-13/16" (300mm)	6-5/16" (160mm)	

BEFORE OPERATING ANY EQUIPMENT, READ AND FAMILIARIZE YOURSELF WITH THESE USE AND SAFETY INSTRUCTIONS

Congratulations on your purchase of this WINCO® commercial equipment. WINCO takes pride in the quality of its products. When used as intended and with proper care and maintenance, you will experience years of reliable operation from this equipment. To ensure best results, it is important that you read and follow the instructions in this manual carefully. It's important to save these instructions for future reference.

Commercial Electric Warmer, 4/3rd Size

Important For Future Reference

Please complete the following information and retain this manual for the life of the product. This information is required for Warranty Service and/or parts. Please see Page 10 for more information on your Warranty and How to Register.

FW-L600

Model Number

Serial Number

Date Purchased



WARNING: IMPROPER INSTALLATION, ADJUSTMENT, ALTERATION, SERVICE OR MAINTENANCE CAN CAUSE PROPERTY DAMAGE, INJURY, OR DEATH. READ THE INSTALLATION, OPERATION, AND MAINTENANCE INSTRUCTIONS THOROUGHLY BEFORE INSTALLING OR SERVICING THIS EQUIPMENT.

AVERTISSEMENT: TOUTE INSTALLATION, RÉGLAGE, MODIFICATION, RÉPARATION OU ENTRETIEN INCORRECT PEUT OCCASIONNER DES DOMMAGES MATÉRIELS, DES BLESSURES GRAVES OU LA MORT. LIRE LES INTRUCTIONS D'INSTALLATION, D'UTILISATION ET D'ENTRETIEN ATTENTIVEMENT AVANT D'INSTALLER OU DE RÉPARER CET APPAREIL.



CAUTION: THESE MODELS ARE DESIGNED, BUILT, AND SOLD FOR COMMERCIAL USE ONLY. IF THESE MODELS ARE POSITIONED SO THE GENERAL PUBLIC CAN USE THE EQUIPMENT, MAKE SURE THAT CAUTION SIGNS, WARNINGS, AND OPERATING INSTRUCTIONS ARE CLEARLY POSTED NEAR EACH UNIT SO THAT ANYONE USING THE EQUIPMENT WILL USE IT CORRECTLY AND NOT INJURE THEMSELVES OR HARM THE EQUIPMENT.

ATTENTION: CES MODÈLES SONT CONÇUS, FABRIQUÉS, ET VENDUS POUR UN USAGE COMMERCIAL SEULEMENT. SI CES MODÈLES SONT PLACÉS POUR QUE LE GRAND PUBLIC PUISSE LES UTILISER, ASSUREZ-VOUS QUE LES CONSIGNES D'ATTENTION, D'AVERTISSEMENT, ET LES INSTRUCTIONS D'UTILISATION SOIENT CLAIEMENT AFFICHÉES PRÈS DE CHAQUE UNITÉ DE SORTE QUE N'IMPORTE QUEL UTILISATEUR DE L'APPAREIL L'EMPLOIE CORRECTEMENT ET NE SE BLESSE PAS OU N'ENDOMMAGE PAS L'APPAREIL.



WARNING: A FACTORY AUTHORIZED SERVICE PROVIDER SHOULD HANDLE ALL MAINTENANCE AND REPAIR. BEFORE DOING ANY MAINTENANCE OR REPAIR, ARRANGE FOR SERVICE.

AVERTISSEMENT: UN TECHNICIEN AUTORISÉ PAR L'USINE DEVRA EFFECTUER TOUT L'ENTRETIEN ET LES RÉPARATIONS. AVANT DE FAIRE TOUT ENTRETIEN OU RÉPARATION, VEUILLEZ CONTACTER WINCO.

Introduction

Congratulations on the purchase of your WINCO® countertop equipment. Please take the time to carefully read through this manual to ensure the machine is operated and maintained properly, to ensure the best possible performance from this product for many years.

WINCO will not accept liability if:

- The instructions in this manual have not been followed correctly.
- Non-authorized personnel have tampered with the machine.
- Non-original spare parts are used.
- The machine has not been handled and cleaned correctly.
- There is any use damage to the unit.

Commercial Electric Warmer, 4/3rd Size

Table of Contents

Specifications	1
Warnings	2
Introduction	2
Packaging	3
Important Safeguards.....	4
Operation	6
Cleaning, Care & Maintenance.....	6
Steam Table Pan Configurations	7
Features, Wiring Diagram	8
Exploded View, Parts Listing	9
Safety & Troubleshooting	10
Limited Warranty	11

Package Contents

All units come with an Operating Instruction Manual and the following:

- One Unit - FW-L600

WINCO® prides itself on quality and service, ensuring that at the time of packing, all products are supplied fully functional and free of damage. Should you find any damage as result of freight, please contact your WINCO® dealer immediately.

Function and Purpose

This unit is intended to be used in commercial food-service operations only. It is not intended for household, industrial or laboratory use. Recommended to use with WINCO® stainless steel steam table pans, covers and adaptor bars, or high-heat poly pans and lids.

NOTE

Please remember that this manual and the warning labels do not replace the need to be alert, to properly train and supervise operators, and to use common sense when using this equipment.

Unpacking the Equipment

DISPOSE OF ALL PACKAGING MATERIALS IN AN ENVIRONMENTALLY RESPONSIBLE MANNER.

1. Remove all packing materials and tape, as well as any protective plastic and cardboard from the unit.
2. Clean any glue residue left over from the plastic or tape.
3. Place the unit in the desired position and height.

SAVE THE ORIGINAL BOX AND PACKAGING FOR USE IN PACKAGING AND SHIPPING THE EQUIPMENT IF SERVICES ARE NEEDED.

Important Safeguards

To ensure safe installation and operation, please carefully read and understand the following statements.

Unless the operator is adequately trained and supervised there is a possibility of serious injury. Owners of this equipment bear the responsibility to make certain that this equipment is used properly and safely, and to strictly follow all of the instructions contained in this manual and the requirements of local, state or federal law.

Owners should not permit anyone to touch this equipment unless they are over 18 years old, are adequately trained and supervised, and have read and understood this manual.

Owners should also ensure that no customers, visitors or other unauthorized personnel come in contact with this equipment. It is the responsibility of the owner and the operator to remain alert to any hazards posed by the function of this equipment.

If there is ever uncertainty about a particular task or the proper method of operating this equipment, ask an experienced supervisor.

Safety Warnings

This manual contains a number of precautions to follow to help promote safe use of this equipment.

Improper installation, adjustment, alteration, service or maintenance can cause property damage, injury or death. Read the installation, operation and maintenance instructions thoroughly before installing or servicing this equipment.

FOR YOUR SAFETY

Do not store or use gasoline or other flammable vapors and liquids in the vicinity of this or any other appliance.

WARNING

Improper installation, adjustment, alteration, service or maintenance can cause property damage, injury or death. Read these installation, operating and maintenance instructions thoroughly before installing or servicing this equipment.

TO PURCHASER



Contact your local gas supplier and ask instructions in the event the user smells gas. This information should be posted in a prominent location.



This appliance is hot when in use. Do not let bare skin touch hot surfaces! Always keep flammable/combustible materials such as curtains, napkins, flammable cleaners, etc., away from the unit.



Power must be disconnected at the power source prior to cleaning, or performing any service procedure or repairs.

 HOT	WARNING  AVERTISSEMENT
	USE CAUTION WHEN TOUCHING THE UNIT. Ne touchez pas le liquide chaud ou les surfaces de chauffage lorsque l'appareil chauffe ou en fonctionnement.



Warning

Improper installation, adjustment, alteration, service or maintenance can cause property damage, injury or death. Read all instructions thoroughly before installing or servicing this equipment.

Caution Before Using Appliance

1. Read all instructions carefully. Do not use this appliance for anything other than its intended use.
2. Do not touch surfaces that may be hot - be sure to always use handles or knobs.
3. Unplug from outlet when not in use, prior to installing or when removing parts, and before cleaning. **DO NOT CLEAN THE UNIT WHEN IT IS HOT. DO NOT** pull by the cord to disconnect.
4. To protect against the risk of electrical shock, do not immerse the appliance, cord or plug in water or other liquids.
7. The use of accessory attachments not recommended by WINCO® may cause fire, electric shock or injury.
8. Not intended for outdoor installation.
9. Do not let the cord hang over the edge of a table or counter, or touch hot surfaces.
10. Do not run the power cord under carpeting, runners or in high-traffic areas to avoid a tripping hazard.

	WARNING ⚠️ AVERTISSEMENT	
	Electrical Shock Hazard Keep water and other liquids from entering the inside of the unit. Liquid inside the unit could cause an electrical shock.	Risque de choc électrique Conserver l'eau et d'autres liquides de pénétrer à l'intérieur de l'appareil. Liquide à l'intérieur de l'appareil pourrait provoquer un choc électrique.
Do not spray water or cleaning products. Liquid could contact the electrical components and cause a short circuit or an electrical shock. Do not use unit if power cord is damaged or has been modified.	Ne pas pulvériser de l'eau ou des produits de nettoyage. Le liquide pourrait contacter avec les composants électriques et causer un court-circuit ou un choc électrique. Ne pas utiliser l'appareil si le cordon d'alimentation est endommagé ou a été modifié.	

CAUTION HOT	WARNING Burn Hazard. The surfaces and outside covering/containment unit may become HOT during and after use.
USE CAUTION WHEN TOUCHING UNIT.	

5. Do not use an adapter or extension cord. Do not remove ground.
6. Do not operate this device or any other electrical equipment with a damaged cord or plug, or after the unit malfunctions, is dropped or damaged in any manner. Return to the nearest WINCO® Authorized Service Center for examination, repair, and/or adjustment.
11. Do not place on or near a heat source.
12. This appliance should always be on a level, stable and steady non-slip countertop or table, away from flammables or water-sources.
13. This appliance is not intended for use by individuals (including children) with reduced or impaired physical, sensory, or mental capabilities, or lack of experience or knowledge, unless they have been given proper supervision or instruction concerning the use of this appliance by a person responsible for their safety.
14. Children should be supervised at all times to ensure that they do not play with or near this appliance.
15. Do not store any item on top of this unit when in operation.
16. Never place easy-to-burn or melt materials in, on or near the unit, such as paper, cardboard, plastic, etc. Make sure all packing material has been removed before using.

Proper Grounding

This machine is provided with a three-pronged grounding plug. The outlet to which this plug is connected must be properly grounded. If the receptacle is not the proper grounding type, contact an electrician. **DO NOT**, under any circumstances, cut or remove the third ground prong from the power cord or use any adapter plug.



	WARNING ⚠️ AVERTISSEMENT	
	Fire Hazard. Correct installation precautions, procedures and regulations must be followed. Operation and safety training is necessary for all users of this equipment.	Risque d'incendie La surchauffe des vapeurs d'huile ou de l'huile peut s'enflammer et provoquer un incendie. Surveillez la température, la qualité et le niveau d'huile. Utilisez et entretenez le système d'élimination des vapeurs d'huile.

Prepare For Use

1. Set unit on a level, flat and stable non-combustible surface that is near the power source/outlet.
2. Pour 1 to 1-1/2 inches of water into the unit well pan.
DO NOT exceed 1-1/2 inches.
DO NOT OPERATE WITHOUT WATER IN THE WELL PAN. Using the unit without water will cause metal fatigue and excess wear on metal components, resulting in rendering the unit inoperable.
Use care when handling hot water and steam.
3. If the unit fails to work properly during initial use, please notify customer service at: returns@wincous.com

Operation

1. Plug cord into properly grounded outlet with the correct voltage and power requirement. *Electrical shock may occur if appliance is not grounded properly.*
2. Preheat the water in the unit well pan. Faster preheat can be achieved by covering the water-filled well pan with an empty full-size food pan or a full-size food pan cover.

Set the heat control to the maximum heat setting for the following specified time:

Unit	Pre-heating time in minutes, with cover	
	Hot Water	Cold Water
FW-L600	12	30

3. Place stainless steel or high-heat poly pans (inset pans) into the unit well pan. Contents placed in the food pans should be previously cooked, as the purpose of the warmer is to hold contents at the proper desired temperature.
4. Place frozen foods into the recommended inset pan(s) and follow the preparation instructions that accompany the frozen food product, before placing into the warmer.
5. **Never place foods directly into the well pan.** The well pan is for water only. Foods must always be placed into an inset pan.
6. Inset pans must be covered to maintain temperatures while food is not being served.
7. For the function of hot food holding, set the heat control to the desired setting.
Monitor temperature regularly to ensure food safety.
8. During normal operation for food warming and holding, also periodically check the water level. Add hot water when necessary and stir food occasionally.

NOTE

Chlorinated chemical residue could damage the unit by degrading the stainless steel surfaces.

1. To remove calcified scale buildup use 1 teaspoon of white vinegar to 1 cup of water. Pour enough into the well pan to cover the bottom. Let this stand for about 30 minutes. Rinse out and repeat if necessary.

Always unplug the electrical power from the unit before cleaning.

Proper cleaning instructions must be followed; otherwise, operation of the unit may be seriously impaired. Do not wash parts in an automatic dishwasher.

WINCO authorized service personnel must perform any other servicing.

Cleaning & Maintenance

Cleaning the unit daily will increase the operational life span of this appliance. Also, regular cleaning will enhance the performance of this appliance.

1. **ALWAYS** unplug the the unit before cleaning.
2. Carefully empty the remaining hot water in the well pan.
3. Wipe inside the emptied well pan with a clean, damp cloth.
4. **NEVER** immerse the unit in water or other liquid. Do Not spray any type of cleaning solution directly onto unit.

5. **DO NOT** hose down, immerse or pressure wash any part of the unit.
6. If soap or chemical cleaners are used, make sure they are rinsed away thoroughly with clean water immediately after cleansing. **DO NOT** use any cleaning fluids that can be harmful to humans.

Always disconnect or unplug the electrical power from the unit before cleaning.

Steam Table Pan Configuration Examples

Utilize stainless steel steam table pans, insets, round adaptor plates and adaptor bars (sold separately) by WINCO® to achieve the following popular pan configurations, or customize for all of your serving needs:



(4) Third-size pans



(1) Full-size pan,
(1) Third-size pan

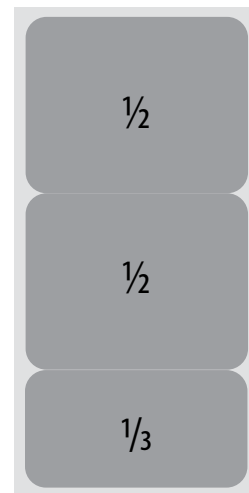

(2) Half-size pans,
(1) Third-size pan

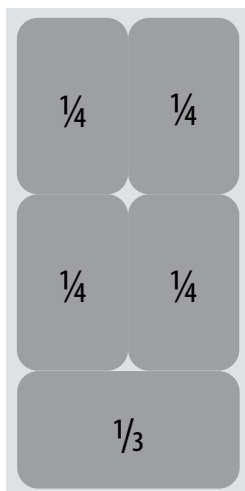

(4) Quarter-size pans,
(1) Third-size pan



(3) Third-size pans,
(2) Sixth-size pans

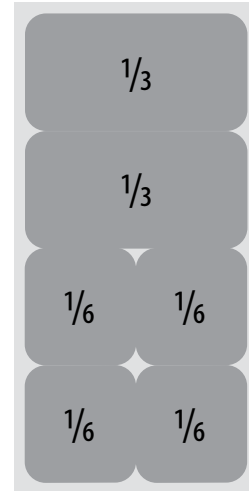

(2) Third-size pans,
(4) Sixth-size pans

Model FW-L600

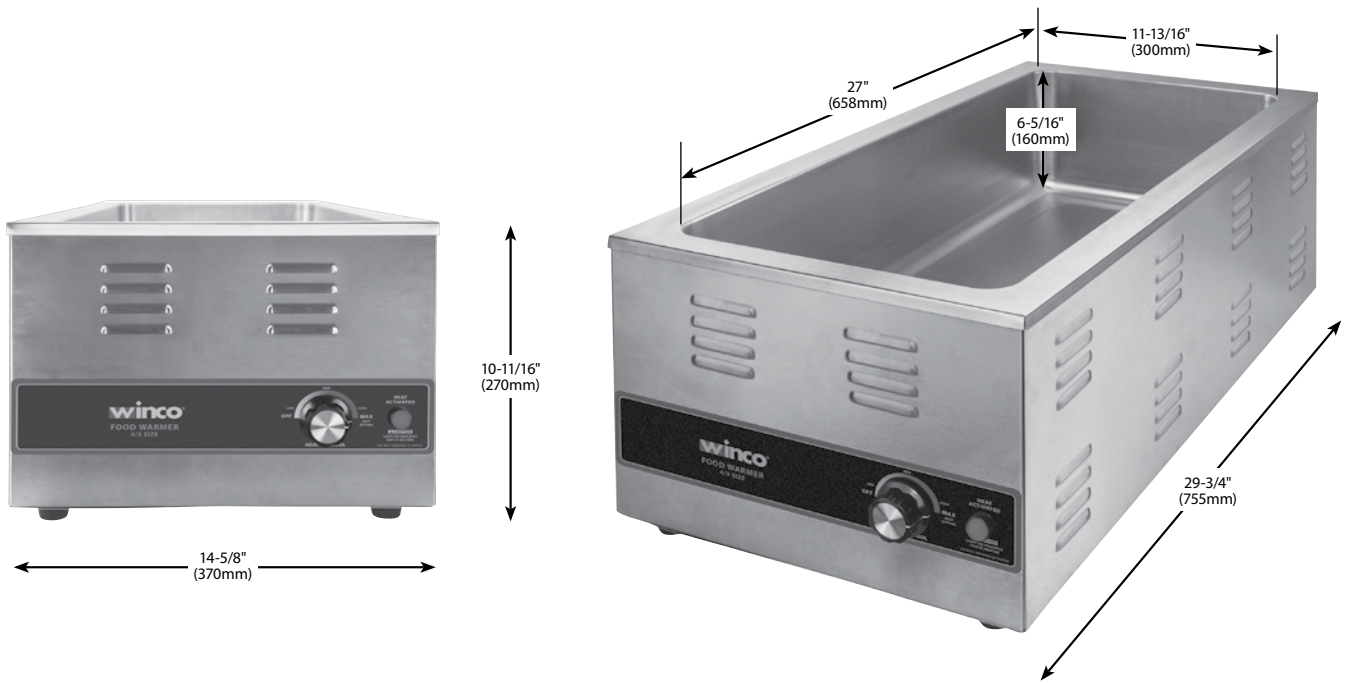

Wiring Diagram

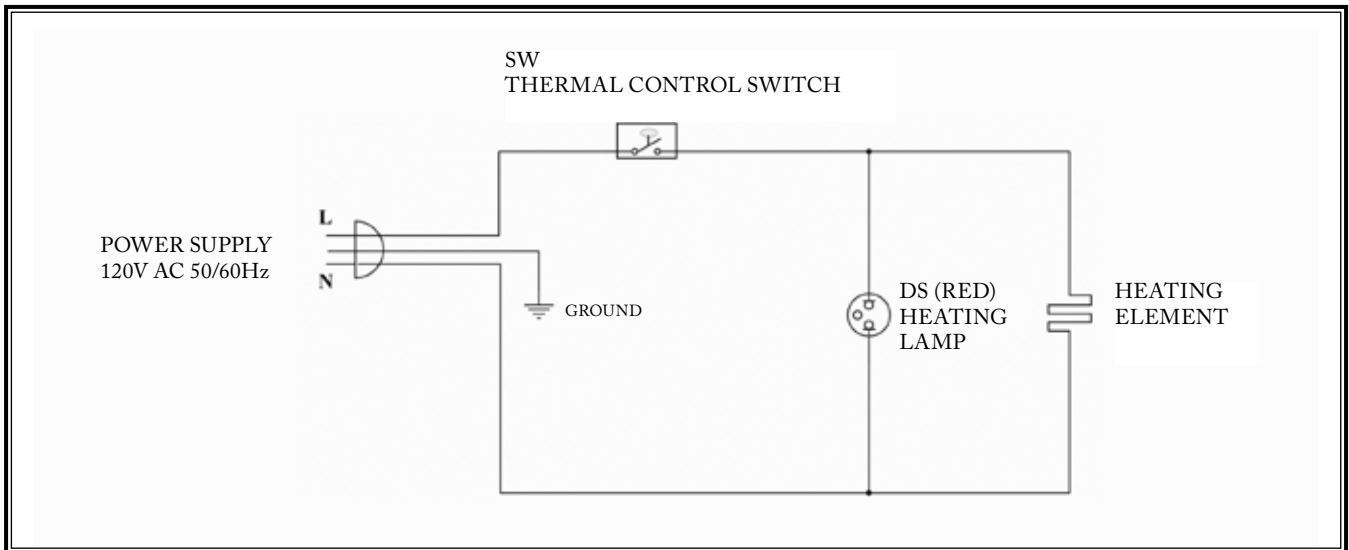

Exploded View

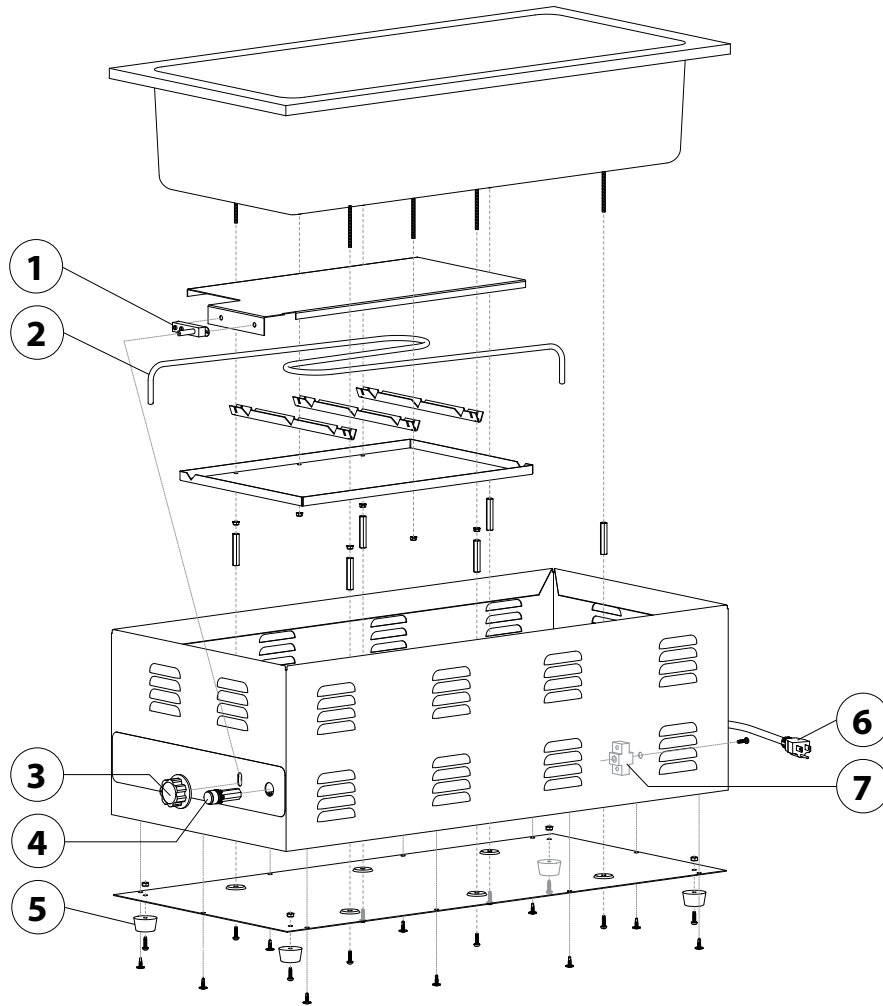

Parts List

MODEL FW-L600

NO.	PARTS	QTY	ITEM#
1	Creep-Style Thermostat	1	FWS500-P7
2	Tubular Heating Element	1	FWS600-P3
3	Adjustable Power Knob for Thermostat	1	FWS600-P5
4	Red Power Indicator Light	1	FWS500-P10
5	Rubber Feet	4	FWS500-P59
6	#14 AWG Power Cord	1	FWS600-P6
7	Terminal Block	1	FW-TB

Safety

A WINCO® Approved Service Technician should carry out repairs if necessary. Do not remove any components or service panels on this product.

If the power cord is damaged, it must be replaced by a WINCO Approved Service Technician in order to avoid a hazard.

Service and Repair

There are no user serviceable parts within this appliance. To avoid serious injury or damage, **NEVER** attempt to repair the unit yourself.

To initiate warranty service contact: support@wincous.com or call: 973-295-3899.

DO NOT send unit to WINCO without first contacting our customer service department.

See "Limited Warranty" section on page 11 for details.

Troubleshooting

If your WINCO appliance does not operate, please check the following prior to placing a service call.

PROBLEM	MIGHT BE CAUSED BY	COURSE OF ACTION
Unit will not heat	Power supply	Check power source & make sure unit is plugged in
	Thermostat setting incorrect	Make sure thermostat is turned to desired setting
	Water level incorrect	Make sure well pan has correct amount of water
	Plug/cord, set or external wiring is damaged	Call Winco to make service arrangements through their service provider network
	Internal wiring fault	
Food remains cold, not reaching desired temperature	Operation of thermostat	Ensure thermostat is set correctly and that the heat control knob is firmly secured to the thermostat shaft (not spinning independently)
	Faulty thermostat	Call Winco to make service arrangements
Indicator light is not on but the unit is heating up	The indicator bulb has burned out	Call Winco to make service arrangements
Product exceeds desired temperature	Faulty heating elements	Call Winco to make service arrangements
	Wrong setting of thermostat	Ensure thermostat is set correctly and that the heat control knob is firmly secured to the thermostat shaft (not spinning independently)
	Faulty thermostat	Call Winco to make service arrangements
Appliance trips circuit breaker or blows fuse	Circuit overload	Check to make sure circuit is not overloaded
	Blown fuse	Unplug from power and check for short circuits
	Faulty thermostat	Call Winco to make service arrangements

Limited Warranty

WINCO® warrants to the original purchaser of new equipment that said equipment, when installed in accordance with our instructions within North America and subjected to normal use, is free from defects in material or workmanship for a period of 1 year. The labor warranty is one year from original installation or 18 months from actual factory shipment date, whichever date occurs first.

THIS WARRANTY IS IN LIEU OF ALL OTHER WARRANTIES, WHETHER EXPRESSED OR IMPLIED. WINCO EXPRESSLY DISCLAIMS ANY IMPLIED WARRANTY OF MERCHANTABILITY OR EXPRESSED OR IMPLIED WARRANTY OF FITNESS FOR A PARTICULAR PURPOSE.

WINCO'S OBLIGATION AND LIABILITY UNDER THIS WARRANTY IS EXPRESSLY LIMITED TO REPAIRING AND REPLACING EQUIPMENT THAT PROVES TO BE DEFECTIVE IN MATERIAL OR WORKMANSHIP WITHIN THE APPLICABLE WARRANTY PERIOD.

IN NO EVENT SHALL WINCO BE LIABLE FOR INCIDENTAL OR CONSEQUENTIAL DAMAGES TO BUYER OR ANY THIRD PARTY, INCLUDING, WITHOUT LIMITATION, LOSS OF PROPERTY, PERSONAL INJURY, LOSS OF BUSINESS OR PROFITS OR OTHER ECONOMIC LOSSES, OR STATUTORY OR EXEMPLARY DAMAGES, WHETHER IN NEGLIGENCE, WARRANTY, STRICT LIABILITY, OR OTHERWISE.

This warranty is given only to the first purchaser from a retail dealer. No warranty is given to subsequent transferees.

Warranty does not cover product failures caused by: failure to maintain, neglect, abuse, damage due to excess water, fire, normal wear, improper set up and use. Periodic maintenance is not covered.

This warranty is not in force until such time as a properly completed and digitally signed Installation/Warranty Registration has been received by WINCO within 30 days from the date of installation.

WARRANTY SERVICE

To initiate warranty service contact: support@wincous.com
or call: 973-295-3899

DO NOT send unit to WINCO® without first contacting our customer service department.

REGISTER ONLINE AT:

<http://support.wincous.com>

Proof of purchase is required to extend warranty more than 1 year from date of shipment from the factory.

THE FOREGOING WARRANTY PROVISIONS ARE A COMPLETE AND EXCLUSIVE STATEMENT BETWEEN THE BUYER AND SELLER. WINCO® NEITHER ASSUMES NOR AUTHORIZES ANY PERSONS TO ASSUME FOR IT ANY OTHER OBLIGATION OR LIABILITY IN CONNECTION WITH SAID EQUIPMENT.

Examples of items not covered under warranty, but not limited to just these items:

1. Acts of God, fire, water damage, burglary, accident, theft.
2. Freight damage.
3. Improper installation or alteration of equipment.
4. Use of generic or after-market parts.
5. Repairs made by anyone other than a WINCO® designated service provider.
6. Lubrication.
7. Expendable wear parts, adjustable feet, blown fuses, lamps, etc.
8. Cleaning of equipment.
9. Misuse or abuse.

Please keep this manual in a safe place for future use!



winco[®]

Model: FW-L600

www.wincous.com