

WELCOME TO #LIVINGHIFI

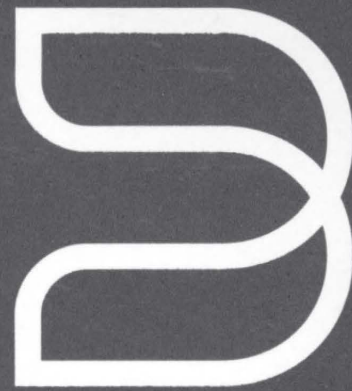

VAULT 2i
QUICK SETUP GUIDE
bluesound.com

WHAT'S IN THE BOX



120V AC Power Cord



230V AC Power Cord



Stereo RCA to RCA Cable



3.5mm Stereo Mini Plug to RCA Cable



Ethernet Cable



Mini Jack to Toslink Adaptor

Qu'y a-t-il dans l'emballage / Qué hay en la caja / Was ist im Lieferumfang enthalten / Cosa contiene la confezione / Wat zit er in de doos
O que está na embalagem / Что входит в комплект поставки

HAVE QUESTIONS? GET IN TOUCH



support.bluesound.com



support@bluesound.com



1-855-531-4666

Toll Free  
English Only

Avez-vous des questions ? / ¿Tienes preguntas? / Noch Fragen? / Domande? / Hebt u vragen? / Tem perguntas? / **Есть вопросы?**

Contacter / Ponte en contacto / Kontaktieren Sie uns / Contattaci / Neem contact met ons op / Contacte-nos / **Свяжитесь с нами**

1

CONNECT FOR SOUND

ANALOG OR OPTICAL TO YOUR EXISTING SYSTEM

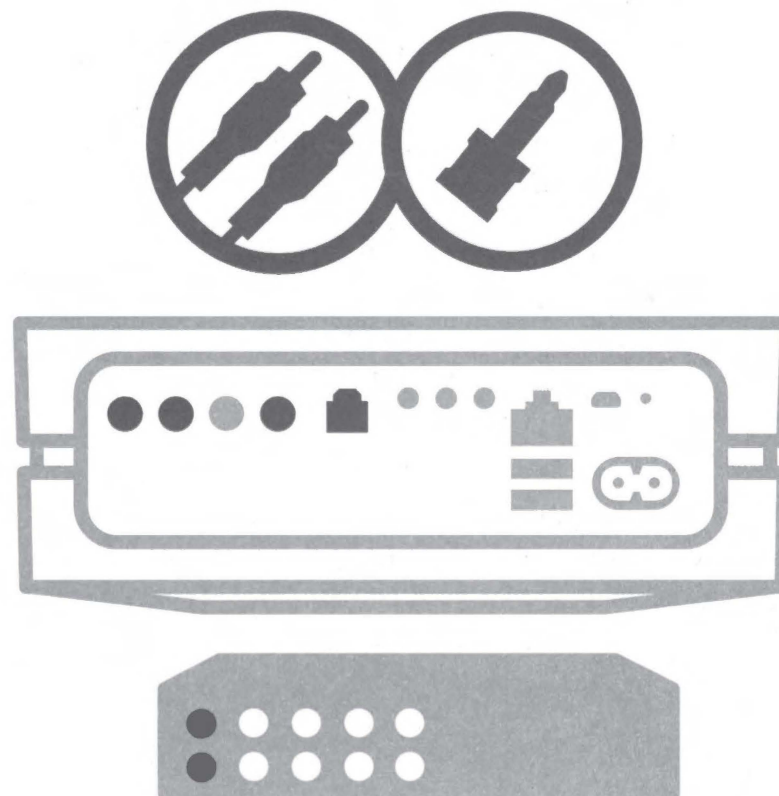

Connectez pour écouter du son / Conecta por sonido / Für die Audiowiedergabe verbinden / Connetti per il suono / Voor geluid aansluiten
Ligação para som / Подключение для воспроизведения звука

Connexion analogique ou optique à votre système en place / Analógico u óptico a tu sistema actual / Analog oder optisch mit Ihrem bestehenden System / Analogico o ottico al tuo sistema esistente / Analoog of optisch voor uw bestaande systeem / Analógica ou ótica ao seu sistema existente / Используйте аналоговое или оптическое подключение к вашей системе

2

PLUG IN YOUR PLAYER

USE ETHERNET FOR NETWORK CONNECTION

AND WATCH FOR THE LED TO TURN SOLID BLUE

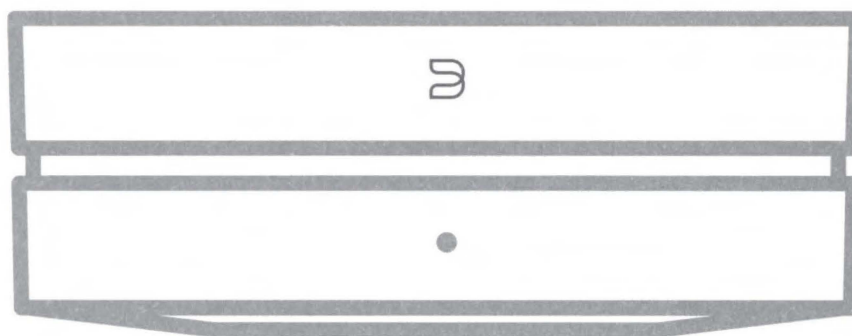

Branchez votre lecteur / Conecta tu reproductor / Verbinden Sie Ihren Player / Collega il lettore / Sluit uw speler aan / Ligue o seu leitor
Подключите плеер

Utilisez l'Ethernet pour la connexion réseau et attendez que la LED affiche un bleu permanent / Usa ethernet para la conexión de red y espera a que el LED se ponga azul fijo / Nutzen Sie für die Netzwerkverbindung Ethernet und achten Sie darauf, dass die Farbe der LED zu Blau wechselt / Usa ethernet per la connessione di rete e attendi che la luce LED diventi blu fissa / Gebruik ethernet voor de netwerkverbinding en wacht tot het ledje ononderbroken blauw oplicht / Use uma ligação Ethernet à rede e aguarde até que o LED fique permanentemente azul / **Используйте Ethernet в качестве сетевого подключения, светодиод будет светиться немигающим синим цветом**

3

GET THE BLUOS APP

USE YOUR PHONE OR TABLET

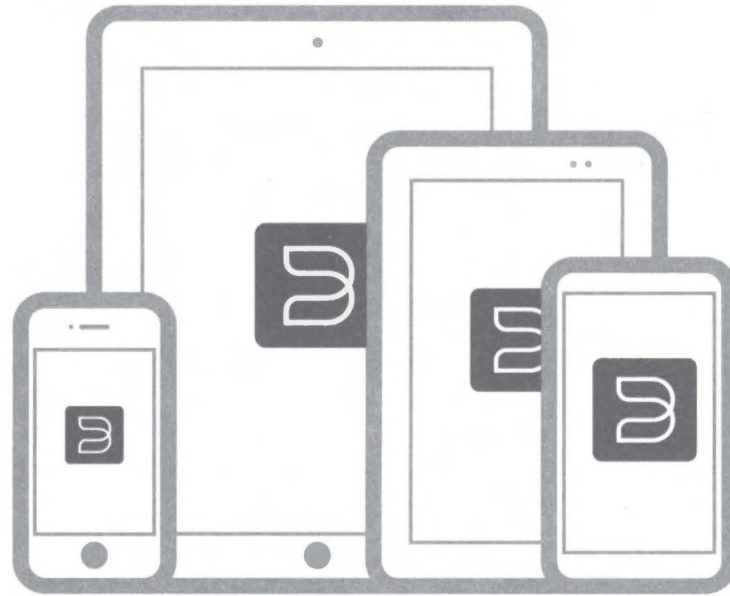

bluesound.com/downloads

Obtenez l'application BluOS / Descarga la app BluOS / Laden Sie die BluOS-App herunter / Ottieni l'app BluOS / Download de BluOS-app / Obtenha a aplicação BluOS / Установите приложение BluOS

Utilisez votre téléphone ou tablette / Usa tu teléfono o tableta / Nutzen Sie Ihr Telefon oder Tablet / Usa il tuo telefono o tablet / Gebruik uw telefoon of tablet / Use o seu telemóvel ou tablet / Используйте телефон или планшет

4

USE THE APP TO FINISH SETUP

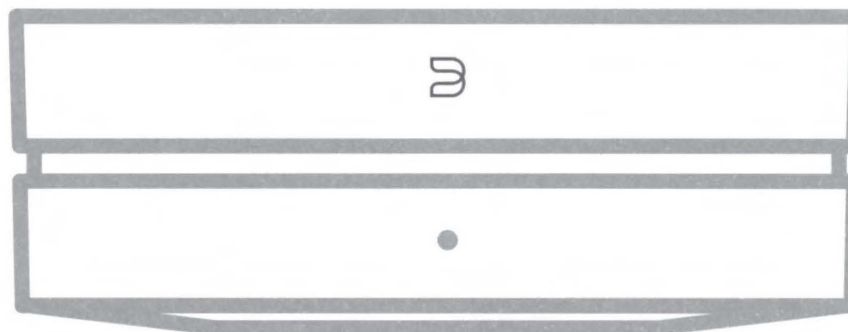

Utilisez l'application pour terminer la configuration / Usa la app para terminar la configuración / Schließen Sie die Einrichtung über die App ab / Usa l'app per completare la configurazione / Voltooi de installatie via de app / Use a aplicação para concluir a instalação
С помощью приложения завершите настройку

© Bluesound International. Bluesound, the stylized wordmark "B" logotype, the phrase "HiFi for a wireless generation", VAULT 2i and all other Bluesound product names and taglines are trademarks or registered trademarks of Bluesound International, a division of Lenbrook Industries Limited. All other logos and services are trademarks or service marks of their respective owners.

PULSE Zi Premium Wireless Streaming Speaker

Owner's Manual

Welcome to Bluesound, Hi-Fi for the Wi-Fi generation.

Bluesound transforms your local digital music library by putting the music of your life right at your fingertips. The clutter of CDs is relegated to a previous era! Your smartphone, desktop or tablet running the Bluesound App now controls your music.

Your Bluesound music system is also a sophisticated Internet streaming device that allows you to listen to a wide range of Internet music service providers. Bluesound also provides access to music subscription services featuring extensive catalogs of millions of songs streamed to you over the internet in real time. TuneIn Radio makes every radio station in the world a local station via the magic of the internet.

To take full advantage of all these Bluesound capabilities requires a robust wired or wireless home network and a reliable high speed Internet connection, provided by a DSL or Cable modem. Internet access must be contracted and installed by your local Internet Service Provider. For remote areas there are satellite options for high speed internet access.

Before signing on to a music subscription or cloud service we suggest that you review your Internet service plan and be sure you have enough internet speed and bandwidth to provide uninterrupted streaming. Most internet service providers offer multiple plans and can help you make the best choice.

For detailed instructions on how to control your Bluesound player, visit our website at : www.bluesound.com.

Included Accessories



120V AC Power Cord



Ethernet Cable



230V AC Power Cord



Mini Jack to Toslink Adaptor

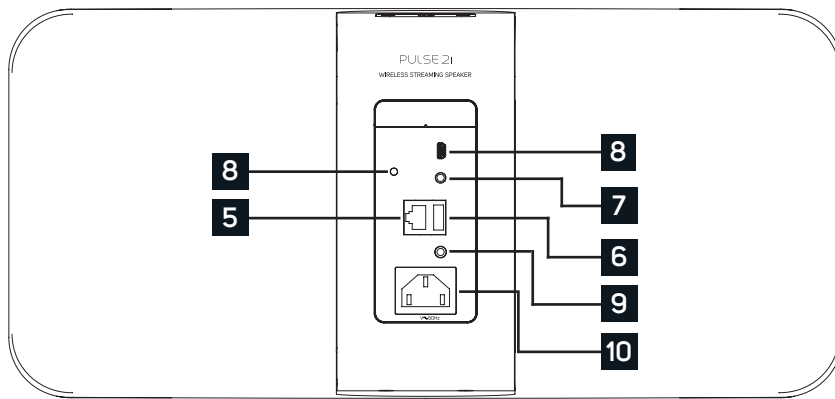
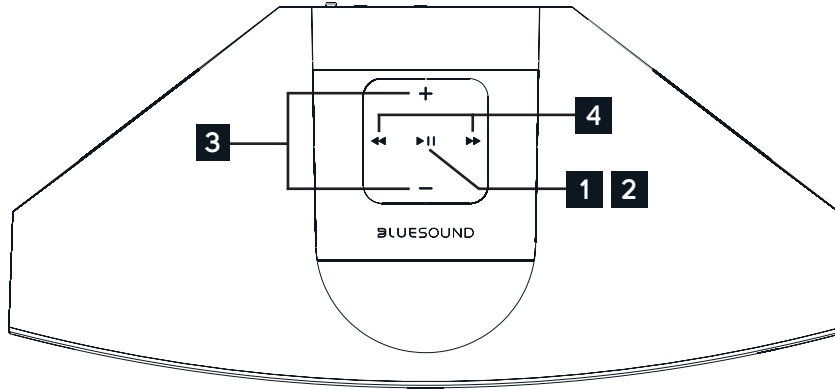

1 STATUS INDICATOR:

Below is a table of the LED blink codes and their corresponding descriptions.

LED BLINK CODE	DESCRIPTION
Short blue flash, then red	Powering up, rebooting the unit
Solid green	Hotspot Mode
Flashing green	Connecting to Network shares
Solid red	Cannot boot; drive error
Red pulse	No internet gateway
White pulse	Software update available
Solid red	Upgrade mode
Alternate flashing red and green	Upgrading...
Flashing blue	Mute mode
Solid white	Indexing
Solid blue	Connected to Network – ready to use with Bluesound App
Flashing red	Factory reset in progress
Solid purple	Hotspot timed out

- 2 PLAY/PAUSE BUTTON:** This button has multiple functions – a visual indicator of network connectivity and a PLAY/PAUSE button. For a full listing of LED Blink Codes, please see #1 – Blink Codes. For an ungrouped Player, press the button to Play and Pause the stream. If listening to an Internet radio stream, the Pause function will work for 30 seconds. At this point, the buffer is full and the stream will Stop. When a Player is grouped, pressing the PLAY/PAUSE button will Mute that Player while other Players continue the stream. The Player's LED will flash blue when muted.
- 3 +, - (VOLUME):** Toggle either button to vary volume level. Volume level will not change if you press and hold either button.
(+): Increase volume level
(-): Decrease volume level
- 4 PREVIOUS TRACK/NEXT TRACK:** These buttons can be used to go back to the previous track ◀◀ or skip to the next track ▶▶ in your current playlist.
- 5 LAN PORT:** The LAN PORT connection can be used with the Ethernet cable provided. This is an optional connection since the PULSE 2i can be connected to the network through a Wi-Fi connection to your router. To setup the PULSE 2i using the LAN Port a Wired Ethernet connection is required. Using the Ethernet cable provided, connect one end of the Ethernet cable to the LAN port of your wired Ethernet broadband router and the other end to the PULSE 2i's LAN port.
- 6 USB (TYPE A):** Connect a USB mass storage device to the USB input. Typical USB mass storage devices compatible with the PULSE 2i include portable flash memory devices and external hard drives (FAT32 formatted).
- 7 OPTICAL IN/ANALOG IN:** Using a 3.5mm Stereo Audio Cable (not provided), connect one end to the Analog In of the PULSE 2i and the other end to the corresponding analog output of other compatible devices. The source will show as an Analog Input in the Navigation Drawer of the Bluesound app. Using an Optical to 3.5mm convertor (included with the PULSE 2i), a digital optical source can also be added. This will appear as Optical Input in the Navigation Drawer.
- 8 SERVICE:** Use the SERVICE port in conjunction with USB (Type B Mini) to initially load firmware on the Player. This is not for consumer use. Only Authorized Bluesound Service personnel can access this USB port and SERVICE control button.
- 9 HEADPHONE JACK:** A 3.5mm headphone jack is located on the back of the PULSE 2i.
- 10 AC MAINS INPUT:** The PULSE 2i comes supplied with two separate AC power cords. Select the AC power cord appropriate for your region. Before connecting the plug to the wall outlet, connect firmly the other end of the AC power cord to PULSE 2i's AC Mains input socket. Never force the plug into a wall outlet. An adaptor may be necessary in certain regions. Always disconnect the plug from the wall outlet first, before disconnecting the cable from the PULSE 2i's AC Mains input socket.

WARNING!

THIS IS A FACTORY RESET OF YOUR PLAYER. ALL CUSTOMIZATION INCLUDING WI-FI NETWORK CONFIGURATION, FILE SHARES AND SAVED PLAYLISTS WILL BE LOST. YOU WILL HAVE TO RE-CREATE THESE ONCE COMPLETE. THIS PROCESS IS ONLY RECOMMENDED IF YOUR PLAYER IS NOT FUNCTIONING AND AN INTERNET FIRMWARE UPGRADE HAS FAILED. FOR ANY QUESTIONS OR CONCERNS CONTACT AN AUTHORIZED BLUESOUND CUSTOMER REPRESENTATIVE BEFORE PROCEEDING!

Steps to Factory Reset:

1. Disconnect the player from electrical power.
2. Wait 10 seconds
3. Reconnect the power
4. The LED will flash Blue – once you see it turn Red, touch and hold the Play/Pause icon (it will immediately turn Green and then back to Red) – do not let go of the LED.
5. Once the LED turns back to Red, continue to hold the button for 30 seconds.
6. After 30 seconds, the LED will begin to blink red – then release the button.

All customization to the Bluesound player will be removed and restored to factory settings.

IMPORTANT: Removing your finger from the LED at any time before the LED begins flashing red will cancel the factory reset and leave the player in Upgrade Mode. Just start the steps again to factory reset the player.

You will know the factory reset is successful if the player returns to Hotspot mode (wireless connection - the LED will turn solid green). If the player is connected to your network through a wired Ethernet connection, it will simply connect as if it was a new player (LED will turn solid blue).

BLUESOUND®

© Bluesound International. Bluesound, the stylized wordmark and "B" logotype, the phrase "HiFi for a wireless generation", PULSE 2i and all other Bluesound product names and taglines are trademarks or registered trademarks of Bluesound International, a division of Lenbrook Industries Limited. All other logos and services are trademarks or service marks of their respective owners.

BluOS™



BluOS Alexa Skill Commands

"Alexa, ask Blue Voice to..."

General Notes for Using the BluOS Alexa Skill

- This skill will be updated periodically. Go to <https://www.bluos.net/voice-skills> for the most up-to-date list of accepted commands.
- Invocation Name: **BluVoice (Blue Voice)**.
- “Alexa, Ask Blue Voice to...” should preface every command.
- Once it has been set, the default room doesn’t need to be stated with every command.
- Default room can be changed verbally at any time.
- Add “in the [room name]” to the end when you want a command to go to a room different than the default room.
- For TuneIn please set up a preset on your Bluesound Player. You can find out how to do that at <https://www.bluesound.com/presets>.
- TuneIn stations have call letters, call names and sometimes a mix of both. For best results, set up your favourite TuneIn stations in BluOS as presets and then call for the corresponding preset number.
- Grouping requires you to log-in to your Amazon Alexa account for each product. Choose a Player, go to **Music Services**, select Amazon Alexa and log-in. Do this for each player you want to use as a recipient of commands regardless of how many Amazon devices you have.
- Please make sure you only use a Room Name once. Multiple instances of the same Room Name can cause system confusion.
- Please use the following list as a guide for names that can be easily recognized:
 - Basement
 - Bathroom
 - Bedroom
 - Deck
 - Den
 - Dining Room
 - Ensuite
 - Foyer
 - Game Room
 - Garage
 - Guest Room
 - Home Theater
 - Kids Room
 - Kitchen
 - Library
 - Living Room
 - Office
 - Pantry
 - Party Room
 - Patio
 - Pool
 - Studio
 - Study
 - Sunroom
 - TV Room
- You may still be able to use a Room Name not listed, however the success rate will diminish. When you sign in to Amazon Alexa in the BluOS Controller app you’ll see a drop-down menu for Room Names. Changing the Room Name here also changes it in the BluOS Controller app.

General Notes for Using the BluOS Alexa Skill

Music Services:

SERVICES	FAVORITES	TOP	NEW	RECOMMENDED
Tidal	•	•	•	•
Amazon	•	•	•	
Napster	•			
Qobuz	•			
Deezer	•	•		
Local Library	•			
Tunein	(preset only)			

This matrix shows what music services are currently supported, and what features can be accessed within each service.

Category – FAVORITES

Phrases that can be used are:

“my music”, “my tracks”, “my songs”, “favorites”, “my favorites”

Category - TOP

Phrases that can be used are:

“hits”, “hit songs”, “popular songs”, “popular tracks”, “hot songs”, “hot tracks”, “top songs”, “top tracks”

Category – NEW

Phrases that can be used are:

“new songs”, “new tracks”, “new music”

Category – RECOMMENDED

Phrases that can be used are:

“music for me”, “tracks for me”, “songs for me”, “suggested songs”, “suggested tracks”, “recommended songs”, “recommended tracks”

For Local Music (your personal library)

Phrases that can be used are:

“my library”, “my tracks”, “local”, “local content”, “my music”, “local music”

Examples:

“Alexa, ask Blue Voice to play my favorites on Tidal”

“Alexa, ask Blue Voice to play hot songs on Deezer”

“Alexa, ask Blue Voice to play new music on Amazon”

“Alexa, ask Blue Voice to play suggested songs on Tidal”

“Alexa, ask Blue Voice to play my songs in my library”

Radio Paradise

We can directly access the Radio Paradise music service.

“Alexa, ask Blue Voice to play Radio Paradise”

- Play Radio Paradise
- Play Radio Paradise in the {room}

Setting a player as default

“Alexa, ask Blue Voice to set the default player to the living room”

- Set the default player to the {room}
- Set the default room to the {room}
- Change the default player to the {room}
- Change the default room to the {room}

Starting a BluVoice music preset

“Alexa, ask Blue Voice to start preset 3”

- Play preset {number}
- Play preset {number} in the {room}
- Play preset number {number}
- Play preset number {number} in the {room}
- Start preset {number}
- Start preset {number} in the {room}
- Start preset number {number}
- Start preset number {number} in the {room}
- Preset {number}
- Preset number {number}
- Preset number {number} in the room

Note: Voice control supports 40 presets.

Pause

“Alexa, ask Blue Voice to pause in the living room”

- Pause
- Pause in the {room}
- Stop
- Stop in the {room}
- Stop playing
- Stop playing in the {room}

Resume

“Alexa, ask Blue Voice to resume”

- Play
- Play in the {room}
- Resume
- Resume in the {room}

Note: “resume” only works on the default player.

Asking what’s playing currently

“Alexa, ask Blue Voice what’s playing in the bedroom”

- What’s playing
- What’s playing in the {room}
- What is playing
- What is playing in the {room}
- Who is playing
- Who is playing in the {room}
- Who’s playing
- Who’s playing in the {room}
- Tell me who’s playing
- Tell me who’s playing in the {room}

Clearing the play queue

“Alexa, ask Blue Voice to clear tracks”

- Clear songs
- Clear songs in the {room}
- Clear tracks
- Clear tracks in the {room}
- Clear queue
- Clear queue in the {room}
- Clear playlist
- Clear playlist in the {room}

Muting the music

“Alexa, ask Blue Voice to mute”

- Mute
- Mute the {room}
- Mute in the {room}

Un-muting the music

“Alexa, ask Blue Voice to unmute”

- Unmute
- Unmute the {room}
- Unmute in the {room}

Decreasing the music volume

“Alexa, ask Blue Voice to turn the volume down”

- Decrease the volume level
- Decrease the volume level in the {room}
- Decrease the volume
- Decrease the volume in the {room}

Decreasing the music volume (cont.)

“Alexa, ask Blue Voice to turn the volume down”

- Decrease the level
- Decrease the level in the {room}
- Turn the volume level down
- Turn the volume level down in the {room}
- Turn the volume down
- Turn the volume down in the {room}
- Turn the level down
- Turn the level down in the {room}
- Turn it down
- Turn it down in the {room}
- Lower the volume level
- Lower the volume level in the {room}
- Lower the volume
- Lower the volume in the {room}
- Lower the level
- Lower the level in the {room}

Increasing the music volume

“Alexa, ask Blue Voice to turn it up”

- Increase the volume level
- Increase the volume level in the {room}
- Increase the volume
- Increase the volume in the {room}
- Increase the level
- Increase the level in the {room}
- Turn the volume level up
- Turn the volume level up in the {room}
- Turn the volume up
- Turn the volume up in the {room}
- Turn the level up

Increasing the music volume (cont.)

- Turn the level up in the {room}
- Turn it up
- Turn it up in the {room}
- Raise the volume level
- Raise the volume level in the {room}
- Raise the volume
- Raise the volume in the {room}
- Raise the level
- Raise the level in the {room}

Setting a specific music volume

“Alexa, ask Blue Voice to change the volume level to 50”

- Set the level to {level}
- Set the level to {level} in the {room}
- Set the volume to {level}
- Set the volume to {level} in the {room}
- Set the volume level to {level}
- Set the volume level to {level} in the {room}
- Change the volume level to {level}
- Change the volume level to {level} in the {room}
- Change the volume to {level}
- Change the volume to {level} in the {room}

Accessing Playlists, Albums and Artists

“Alexa, ask Blue Voice to play workout tunes playlist”

- Play {album} by {artist}
- Play {album} by {artist} in the {room}
- Play {playlist}
- Play {playlist} in the {room}”

Repeating a music playlist

“Alexa, ask Blue Voice to turn playlist repeat on”

- Turn playlist repeat on
- Turn playlist repeat on in the {room}
- Turn queue repeat on
- Turn queue repeat on in the {room}

Turning music playlist repeat off

“Alexa, ask Blue Voice to turn playlist repeat off”

- Turn playlist repeat off
- Turn playlist repeat off in the {room}
- Turn queue repeat off
- Turn queue repeat off in the {room}

Repeating music tracks

“Alexa, ask Blue Voice to turn repeat track on in the living room”

- Repeat on
- Turn repeat song on
- Turn repeat track on
- Turn repeat song on in the {room}
- Turn repeat track on in the {room}

Clearing music repeat

“Alexa, ask Blue Voice to repeat off”

- Repeat off
- Turn repeat song off
- Turn repeat track off
- Turn repeat song off in the {room}
- Turn repeat track off in the {room}

Music shuffle

“Alexa, ask Blue Voice to shuffle songs”

- Shuffle songs
- Shuffle songs in the {room}

Stop music shuffle

“Alexa, ask Blue Voice to reset shuffle”

- Reset shuffle
- Reset shuffle in the {room}

Previous

“Alexa, ask Blue Voice to repeat the song”

- Repeat the song
- Repeat
- Go back
- Start over
- Replay the song

Next

“Alexa, ask Blue Voice to skip”

- Skip to the next song
- Skip this song
- Skip
- Next song

Grouping all Players

For grouping in general please remember that you need to log-in to each Player, go to **Music Services**, select Amazon Alexa and log-in Amazon using your Amazon credentials. It is not required to have an Amazon device in each room.

“Alexa, ask Blue Voice to group all the rooms”

- Group all the rooms together
- Group the rooms together
- Group all the rooms
- Group rooms
- Group all

Grouping Players

For Player grouping, you are adding a Player to another which is already playing. For example, if the Bedroom is playing and you want to add the Kitchen, you would group the Kitchen with the Bedroom:

“Alexa, ask Blue Voice to group the Kitchen with the Bedroom”

- Group the {new room} and the {playing room} together
- Group the {new room} and {playing room} together
- Group the {new room} and the {playing room}
- Group the {new room} and {playing room}
- Group the {new room} with the {playing room}
- Group the {new room} with {playing room}

Ungrouping Players

“Alexa, ask Blue Voice to remove the Den from the Living Room group”

- remove the {remove room} from the {playing room} group

Services

So far the only Internet Radio stream you can request is Radio Paradise

“Alexa, ask Blue Voice to play Radio Paradise”

- Play Radio Paradise in the {room}

BLUESOUND®

IMPORTANT – PLEASE READ THE TERMS OF THIS LICENSE AGREEMENT CAREFULLY BEFORE USING YOUR BLUESOUND PRODUCT OR DOWNLOADING ANY SOFTWARE OR SOFTWARE UPDATE. BY USING YOUR BLUESOUND PRODUCT, OR DOWNLOADING ANY SOFTWARE, FIRMWARE OR DOCUMENTATION YOU ARE AGREEING TO BE BOUND BY THE TERMS OF THIS LICENSE AGREEMENT. IF YOU DO NOT AGREE TO THE TERMS OF THIS LICENSE AGREEMENT, YOU MAY RETURN THE BLUESOUND PRODUCT WITHIN 30 DAYS OF PURCHASE TO THE RETAIL LOCATION WHERE YOU PURCHASED IT, TOGETHER WITH THE ORIGINAL RECEIPT AND ALL PACKAGING, FOR A REFUND.

License

Bluesound International, a division of Lenbrook Industries Limited (“Bluesound”), furnishes this Bluesound Software [defined to include the software embedded in your Bluesound product (as updated from time to time) and any desktop or handheld application portions of the software] and accompanying documentation, and licenses their use to you as provided in this Agreement.

Under this Agreement, Bluesound grants you a non-exclusive, non-transferable, non-sublicenseable, royalty-free limited license to use the Bluesound Software for the purpose of operating your Bluesound product and the related desktop or handheld device applications on any personal computer or handheld device owned or controlled by you. Except as described above, you may not transfer the Bluesound Software to any other computing device or remove the Bluesound Software from your Bluesound product. Notwithstanding any license granted herein by Bluesound, you acknowledge and agree that it is your sole responsibility to comply with U.S. and International copyright laws with respect to your use of the Software.

You agree not to modify, adapt, translate, reverse engineer, decompile, or disassemble the Bluesound Software, in whole or in part, except as expressly provided for in this agreement or upon Bluesound’s written request. In addition, you agree not to transfer or disclose the Bluesound Software, the accompanying online documentation or any program you develop from them in whole or in part, to any third party except upon Bluesound’s prior written approval. Finally, you agree not to use Bluesound product in whole or in part for any purpose other than as outlined in the online documentation.

Except for the limited license granted herein, Bluesound and its suppliers hereby retain all right, title and interest in and to all worldwide intellectual property rights embodied in the Bluesound Software. All other rights are reserved by Bluesound.

Notwithstanding the foregoing license grant, you acknowledge that certain components of the Bluesound Software may be covered by third party software licenses (“Third Party Components”). To the extent required by the licenses covering Third Party Components, the terms of such licenses will apply in lieu of the terms of this Agreement. The various Third Party Components and their governing licenses are available at bluesound.com/open-source-software.

Termination

The license is effective until terminated. Your rights under this License will terminate automatically or otherwise cease to be effective, without notice from Bluesound, if you fail to comply with any terms of this License. Upon termination of this License you will cease all use of the Bluesound Software, and you will destroy the Bluesound Software and accompanying documentation and all copies you have made of them. In addition, upon termination you will have no recourse against Bluesound for your inability to use the program or accompanying documentation.

Compliance With Copyright Laws

You acknowledge that Bluesound owns all right, title and interest, in all copyrights, trade secrets, and intellectual property related to your Bluesound product, the Bluesound Software and accompanying documentation.

Bluesound complies with U.S. and international copyright laws and in consideration of the license granted herein, you agree to do the same. You acknowledge that unauthorized copying or distribution of music or other content accessed using your Bluesound product is prohibited by such copyright laws, and you agree that you will not, directly or indirectly, copy or distribute any content without the express written authorization of the copyright holder. You agree to indemnify and hold harmless Bluesound and its licensors from and against any and all claims, suits, losses, damages, liabilities, costs and expenses incurred by Bluesound or its licensors arising out of or related to your failure to comply with the terms of this section.

Third Party Content and Technologies Support

From time to time, Bluesound may provide access to third party content providers via the Bluesound Product. In addition, Bluesound may support certain third party technologies, such as specific file formats. Bluesound reserves the right to discontinue access to and/or support for such third party content or technologies at any time, and for any reason. Bluesound makes no representations or warranties whatsoever regarding the selection of, or continuing support for, any such third party content or technologies.

Access to services provided by third parties requires Internet access and may require you to accept additional terms. You agree that Bluesound is not responsible for evaluating or examining any such third party services, technologies or related materials and that Bluesound will not have any liability to you, related to such services, technologies or related materials.

Disclaimer of Warranties

You acknowledge and agree that to the maximum extent permitted by law:

- _ The Bluesound Software and services performed by the Bluesound Software are provided "As Is" with all faults and without warranty of any kind. Bluesound does not warrant against interference with your enjoyment of the Bluesound Software, that the Bluesound Software and related services will meet your requirements or that the Bluesound Software and related services will be uninterrupted or error free.
- _ Bluesound does not warrant that any defects in the Bluesound Software will be corrected or that the Bluesound Software will be compatible or work with any third party software, applications or third party services.
- _ The Bluesound Software and related services are at your risk and the entire risk as to satisfactory quality, performance, accuracy and effort is yours.

Limitation of Liability

To the extent not prohibited by law, in no event will Bluesound or its suppliers be liable for personal injury or any damages whatsoever, including but not limited to, incidental, special, consequential, exemplary, or indirect damages, and including but not limited to, cost of cover, loss of data, loss of profits, business interruption, loss of business information, or other pecuniary loss arising from the use of (or inability to use) the product, no matter how caused and on any theory of liability. Because some jurisdictions do not allow the exclusion or limitation of liability for consequential or incidental damages, some of the above limitations may not apply to you, but they shall apply to the maximum extent permitted by law. In no event shall Bluesound's total liability to you for all damages in any one or more causes of action exceed the lesser of the amount paid by you for your Bluesound product and US\$500. The limitations outlined here will apply even if Bluesound, its suppliers or dealers have been advised of the possibility of such damage or of any type of use intended by you. These limitations shall apply notwithstanding the failure of essential purpose of any limited remedy. You acknowledge that these limitations reflect a reasonable allocation of risk.

Bluesound Privacy Policy

The Bluesound Privacy Policy which can be found at www.bluesound.com/privacy-policy outlines the type of information that may be collected from you by Bluesound and how such information may be used by Bluesound.

GD3 DATA NOTICE

To the extent that the Bluesound Software contains functionality from GD3 Data, you agree to be bound by the terms of the GD3 Software License Agreement, which can be found at <http://www.getdigitaldata.com/GD3EULA Agreement.pdf>. Any use of the Bluesound Software or Bluesound product that does not comply with the GD3 Software License Agreement is prohibited and will result in the immediate termination of this license.

SPOTIFY LICENSING

This product incorporates Spotify software which is subject to the third party licenses found here: <https://developer.spotify.com/esdk-third-party-licenses>.

Controlling Law and Severability

This License will be governed by and construed in accordance with the laws of the Province of Ontario. This license shall not be governed by the United Nations Conventions on Contracts for the International Sale of Goods, the application of which is expressly excluded. If for any reason a court of competent jurisdiction finds any provision, or portion thereof, to be unenforceable, the remainder of the license shall remain in full force and effect.

Important Safety Instructions

Save these instructions for later use.

Follow all warnings and instructions marked on the audio equipment.

- _ **Read instructions** - All the safety and operating instructions should be read before the product is operated.
- _ **Retain instructions** - The safety and operating instructions should be retained for future reference.
- _ **Heed Warnings** - All warnings on the product and in the operating instructions should be adhered to.
- _ **Follow Instructions** - All operating and use instructions should be followed.
- _ **Cleaning** - Unplug this product from the wall outlet before cleaning. Do not use liquid cleaners or aerosol cleaners. Clean only with a dry cloth.
- _ **Attachments** - Do not use attachments not recommended by the product manufacturer as they may cause hazards.
- _ **Water and Moisture** - Do not use this product near water-for example, near a bath tub, wash bowl, kitchen sink, or laundry tub; in a wet basement; or near a swimming pool; and the like.
- _ **Accessories** - Do not place this product on an unstable cart, stand, tripod, bracket, or table. The product may fall, causing serious injury to a child or adult, and serious damage to the product. Use only with a cart, stand, tripod, bracket, or table recommended by the manufacturer, or sold with the product. Any mounting of the product should follow the manufacturer's instructions, and should use a mounting accessory recommended by the manufacturer.



A product and cart combination should be moved with care. Quick stops, excessive force, and uneven surfaces may cause the product and cart combination to overturn.

- _ **Ventilation** - Slots and openings in the cabinet are provided for ventilation and to ensure reliable operation of the product and to protect it from overheating, and these openings must not be blocked or covered. The openings should never be blocked by placing the product on a bed, sofa, rug, or other similar surface. This product should not be placed in a built-in installation such as a bookcase or rack unless proper ventilation is provided or the manufacturer's instructions have been adhered to.
- _ **Power Sources** - This product should be operated only from the type of power source indicated on the marking label. If you are not sure of the type of power supply to your home, consult your product dealer or local power company.
The primary method of isolating the amplifier from the mains supply is to disconnect the mains plug. Ensure that the mains plug remains accessible at all times. Unplug the AC power cord from the AC outlet if the unit will not be used for several months or more.
The socket-outlet shall be installed near the equipment and shall be easily accessible.
- _ **Grounding or Polarization** - This product may be equipped with a polarized alternating-current line plug (a plug having one blade wider than the other). This plug will fit into the power outlet only one way. This is a safety feature. If you are unable to insert the plug fully into the outlet, try reversing the plug. If the plug should still fail to fit, contact your electrician to replace your obsolete outlet. Do not defeat the safety purpose of the polarized plug.
- _ **Power Cord Protection** - Power-supply cords should be routed so that they are not likely to be walked on or pinched by items placed upon or against them, paying particular attention to cords at plugs, convenience receptacles, and the point where they exit from the product.

- _ **Outdoor Antenna Grounding** - If an outside antenna or cable system is connected to the product, be sure the antenna or cable system is grounded so as to provide some protection against voltage surges and built-up static charges. Article 810 of the National Electrical Code, ANSI/NFPA 70, provides information with regard to proper grounding of the mast and supporting structure, grounding of the lead-in wire to an antenna discharge unit, size of grounding conductors, location of antenna discharge unit, connection to grounding electrodes, and requirements for the grounding electrode.
- _ **Lightning** - For added protection for this product during a lightning storm, or when it is left unattended and unused for long periods of time, unplug it from the wall outlet and disconnect the antenna or cable system. This will prevent damage to the product due to lightning and power line surges.
- _ **Power Lines** - An outside antenna system should not be located in the vicinity of overhead power lines or other electric light or power circuits, or where it can fall into such power lines or circuits. When installing an outside antenna system, extreme care should be taken to keep from touching such power lines or circuits as contact with them might be fatal.
- _ **Overloading** - Do not overload wall outlets, extension cords, or integral convenience receptacles as this can result in a risk of fire or electric shock.
- _ **Object and Liquid Entry** - Never push objects of any kind into this product through openings as they may touch dangerous voltage points or short out parts that could result in a fire or electric shock. Never spill liquid of any kind on the product.

Warning

The apparatus should not be exposed to dripping or splashing, and objects filled with liquids, such as vases, should not be placed on the apparatus. As with any electronic products, use care not to spill liquids into any part of the system. Liquids can cause a failure and/or a fire hazard.

- _ **Damage Requiring Service** - Unplug this product from the wall outlet and refer servicing to qualified service personnel under the following conditions:
 - _ When the power supply cord or plug is damaged.
 - _ If liquid has been spilled, or objects have fallen into the product.
 - _ If the product has been exposed to rain or water.
 - _ If the product does not operate normally by following the operating instructions. Adjust only those controls that are covered by the operating instructions as an improper adjustment of other controls may result in damage and will often require extensive work by a qualified technician to restore the product to its normal operation.
 - _ If the product has been dropped or damaged in any way.
 - _ When the product exhibits a distinct change in performance—this indicates a need for service.
- _ **Replacement Parts** - When replacement parts are required, be sure the service technician has used replacement parts specified by the manufacturer or have the same characteristics as the original part. Unauthorized substitutions may result in fire, electric shock, or other hazards.
- _ **Safety Check** - Upon completion of any service or repairs to this product, ask the service technician to perform safety checks to determine that the product is in proper operating condition.
- _ **Heat** - The product should be situated away from heat sources such as radiators, heat registers, stoves or other products (including amplifiers) that produce heat.

Battery shall not be exposed to excessive heat such as sunshine, fire or the like.

Warning

To reduce the risk of fire or electric shock, do not expose this product to rain or moisture.

Caution

To prevent electric shock, match wide blade of plug to wide slot, fully insert.

Warning

Main plug is used to disconnect device and it should remain readily operable during intended use.

Caution

Danger of explosion if battery is incorrectly replaced. Replace only with the same or equivalent type.

RESPONSIBLE PARTY

Lenbrook Industries Limited, 633 Granite Court, Pickering, Ontario L1W 3K1

905-831-6333

Note:

This equipment has been tested and found to comply with the limits for a Class B digital device, pursuant to Part 15 of the FCC Rules. These limits are designed to provide reasonable protection against harmful interference in a residential installation. This equipment generates, uses and can radiate radio frequency energy and, if not installed and used in accordance with the instructions, may cause harmful interference to radio communications. However, there is no guarantee that interference will not occur in a particular installation. If this equipment does cause harmful interference to radio or television reception, which can be determined by turning the equipment off and on, the user is encouraged to try to correct the interference by one or more of the following measures:

- _ Reorient or relocate the receiving antenna.
- _ Increase the separation between the equipment and receiver.
- _ Connect the equipment into an outlet on a circuit different from that to which the receiver is connected.
- _ Consult the dealer or an experienced radio/ TV technician for help.
- _ no naked flame sources such as lighted candles should be placed on the apparatus;
- _ the use of apparatus in tropical climate

This device complies with Part 15 of the FCC rules. Operation is subject to the following two conditions:

- _ This device may not cause harmful interference, and
- _ This device must accept any interference received, including interference that may cause undesired operation.

Warning

Changes or modifications to this unit not expressly approved by the party responsible for compliance could void the user's authority to operate the equipment.

Warning

To reduce the risk of fire or electric shock, do not expose this product to rain or moisture.

Caution

To prevent electric shock, match wide blade of plug to wide slot, fully insert.

Warning

Main plug is used to disconnect device and it should remain readily operable during intended use.

Caution

Danger of explosion if battery is incorrectly replaced. Replace only with the same or equivalent type.

RESPONSIBLE PARTY

Lenbrook Industries Limited, 633 Granite Court, Pickering, Ontario L1W 3K1

905-831-6333

Note:

This equipment has been tested and found to comply with the limits for a Class B digital device, pursuant to Part 15 of the FCC Rules. These limits are designed to provide reasonable protection against harmful interference in a residential installation. This equipment generates, uses and can radiate radio frequency energy and, if not installed and used in accordance with the instructions, may cause harmful interference to radio communications. However, there is no guarantee that interference will not occur in a particular installation. If this equipment does cause harmful interference to radio or television reception, which can be determined by turning the equipment off and on, the user is encouraged to try to correct the interference by one or more of the following measures:

- _ Reorient or relocate the receiving antenna.
- _ Increase the separation between the equipment and receiver.
- _ Connect the equipment into an outlet on a circuit different from that to which the receiver is connected.
- _ Consult the dealer or an experienced radio/ TV technician for help.
- _ no naked flame sources such as lighted candles should be placed on the apparatus;
- _ the use of apparatus in tropical climate

This device complies with Part 15 of the FCC rules. Operation is subject to the following two conditions:

- _ This device may not cause harmful interference, and
- _ This device must accept any interference received, including interference that may cause undesired operation.

Warning

Changes or modifications to this unit not expressly approved by the party responsible for compliance could void the user's authority to operate the equipment.

FCC RF Radiation Exposure Statement

Caution: To maintain compliance with the FCC's RF exposure guidelines, place the unit at least 20cm from nearby persons.

CAN ICS-3 (B)/NMB-3(B)

This device complies with Industry Canada Licence-exempt RSS-standard(s). Operation is subject to the following two conditions:

- (1) this device may not cause Interference, and
- (2) this device must accept any interference, including interference that may cause undesired operation.

Caution regarding placement

To maintain proper ventilation, be sure to leave a space around the unit (from the largest outer dimensions including projections) that is equal to or greater than shown below.

- _ Left and Right Panels: 10 cm
- _ Rear Panel: 10 cm
- _ Top Panel: 10 cm

Applies only to PULSE 2i, PULSE MINI 2i and PULSE SOUNDBAR 2i

Caution

Marking and rating plate are located at the back or bottom of the apparatus.



WARNING – IF THIS PRODUCT IS USED AT 240VAC, A SUITABLE ATTACHMENT PLUG SHOULD BE USED.

CAUTION

**RISK OF ELECTRIC SHOCK
DO NOT OPEN**

WARNING : SHOCK HAZARD - DO NOT OPEN

ATTENTION : RISQUE DE CHOC ÉLECTRIQUE - NE PAS OUVRIR



THE EXCLAMATION POINT WITHIN AN EQUILATERAL TRIANGLE IS INTENDED TO ALERT THE USER TO THE PRESENCE OF IMPORTANT OPERATING AND MAINTENANCE (SERVICING) INSTRUCTIONS IN THE LITERATURE ACCOMPANYING THE APPLIANCE.



THE LIGHTNING FLASH WITH ARROWHEAD SYMBOL, WITHIN AN EQUILATERAL TRIANGLE, IS INTENDED TO ALERT THE USER TO THE PRESENCE OF UNINSULATED "DANGEROUS VOLTAGE" WITHIN THE PRODUCT'S ENCLOSURE THAT MAYBE OF SUFFICIENT MAGNITUDE TO CONSTITUTE A RISK OF ELECTRIC SHOCK TO PERSONS.

Applies only to Bluesound POWERNODE 2i, NODE 2i and PULSE 2i

An electrical appliance that has a terminal with a ground connection must be connected to a receptacle on the supply network protected by a ground connection.

Applies only to Bluesound VAULT 2i

Caution

This equipment employs a Laser System. To ensure proper use of this product, please read the complete owner's manual, available online at www.bluesound.com/support, and retain for future reference. Should the unit require maintenance, contact an authorized service location. Use of controls, adjustments or the performance of procedures other than those specified may result in exposure to laser radiation. To prevent direct exposure to laser beam, do not try to open the enclosure. Visible laser radiation when the enclosure is opened.

CLASS 1 LASER PRODUCT
KLASSE 1 LASER PRODUKT
LUOCAN 1 LASER LAITE
KLASS 1 LASER APPARAT
CLASSE 1 PRODUIT LASER



WARNING – DO NOT STARE INTO BEAM.

Applies only to Bluesound NODE 2i, POWERNODE 2i, PULSE 2i, PULSE MINI 2i, PULSE FLEX 2i and PULSE SOUNDBAR 2i

European union notice for wireless product

Hereby, Lenbrook Industries Limited, declares that the aforementioned wireless music streamer, wireless music streaming amplifier, premium wireless streaming speaker, compact wireless streaming speaker, portable wireless streaming speaker and wireless streaming sound system are in compliance with The RED Directive (2014/53/EU), Low Voltage Directive (2014/35/EU) Electromagnetic Compatibility Directive (2014/30/EU) and other essential requirements. The declaration of conformity may be consulted at www.lenbrook.com/DoC.

Applies only to Bluesound PULSE SOUNDBAR 2i

This equipment should be installed and operated with a minimum distance 20cm between the radiator and your body.



This device complies with Industry Canada licence-exempt RSS standard(s).

Under Industry Canada regulations, this radio transmitter may only operate using an antenna of a type and maximum (or lesser) gain approved for the transmitter by Industry Canada. To reduce potential radio interference to other users, the antenna type and its gain should be so chosen that the equivalent isotropically radiated power (e.i.r.p.) is not more than that necessary for successful communication.

- (i) The device for operation in the band 5150-5250 MHz is only for indoor use to reduce the potential for harmful interference to co-channel mobile satellite systems;
- (ii) The maximum antenna gain permitted for devices in the band 5725-5825 MHz shall comply with the e.i.r.p. limits specified for point-to-point and non-point-to-point operation as appropriate.

Notes on environmental protection



At the end of its useful life, this product must not be disposed of with regular household waste but must be returned to a collection point for the recycling of electrical and electronic equipment. The symbol on the product, owner's manual and packaging, point this out.

The materials can be reused in accordance with their markings. Through re-use, recycling of raw materials or other forms of recycling of old products, you are making an important contribution to the protection of our environment. Your local administrative office can advise you of the responsible waste disposal point.

Information about collection and disposal of waste batteries (directive 2006/66/EC of the European parliament and the council of European Union) (for European customers only)

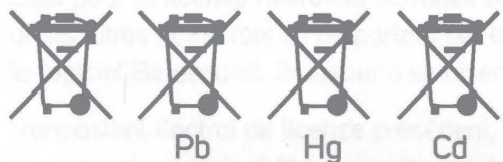

Batteries bearing any of these symbols indicate that they should be treated as "separate collection" and not as municipal waste. It is encouraged that necessary measures are implemented to maximize the separate collection of waste batteries and to minimize the disposal of batteries as mixed municipal waste.

End-users are exhorted not to dispose of waste batteries as unsorted municipal waste. In order to achieve a high level of recycling waste of batteries, discard waste batteries separately and properly through an accessible collection point in your vicinity. For more information about collection and recycling of waste batteries, please contact your local municipality, your waste disposal service or the point of sale where you purchased the items.

By ensuring compliance and conformance to proper disposal of waste batteries, potential hazardous effects on human health is prevented and the negative impact of batteries and waste batteries on the environment is minimized, thus contributing to the protection, preservation and quality improvement of the environment.

Record your model number (now, while you can see it)

The model and serial number are located on the back or bottom of the cabinet. For your future convenience, we suggest that you record these numbers here:

Model no. _____

Serial no. _____

Bluesound is a trademark of Bluesound International, a division of Lenbrook Industries Limited

© Bluesound International, a division of Lenbrook Industries Limited

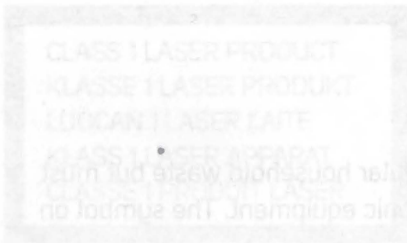

Information about collection and disposal of waste batteries (Directive 2006/66/EC of the European Parliament and the Council of European Union) for European customers only

European Union notice for wireless product

Harmony, Lenbrook Industries Limited, declares that the products listed below are in compliance with the requirements of the European Union Directive 2006/66/EC on batteries and battery packs.



The products listed below are in compliance with the requirements of the European Union Directive 2006/66/EC on batteries and battery packs. The products listed below are in compliance with the requirements of the European Union Directive 2006/66/EC on batteries and battery packs. The products listed below are in compliance with the requirements of the European Union Directive 2006/66/EC on batteries and battery packs.

By ensuring compliance and confidence in proper disposal of waste batteries, potential hazardous effects on human health is prevented and the negative impact of batteries and waste batteries on the environment is minimized, thus contributing to the protection, preservation and quality improvement of the environment.

BLUESOUND

WARRANTY

BLUESOUND INTERNATIONAL, a division of Lenbrook Industries Limited and its Authorized Distributors, warrants this component to be free from all defects in materials and workmanship as follows:

Electronic components and Electro-mechanical products:	One (1) year, parts & labor
Loudspeakers and subwoofer drivers:	Five (5) years
Powered speakers and subwoofers:	One (1) year

This warranty is valid only in the country of purchase. This warranty is non-transferable and is valid for the first original purchaser purchasing from an Authorized Bluesound Retailer or Dealer of products.

How to obtain service:

To obtain warranty service, go to the Bluesound Help Center at www.bluesound.com and click "Ask Us". You can also contact Bluesound at support@bluesound.com. A member of the Bluesound Support Crew will assist you. If you need assistance locating an authorized Bluesound Dealer, please check our Dealer locator at www.bluesound.com.

Note: The Bluesound warranty requires proof-of-purchase prior to any in-warranty repairs. Always retain your original sales slip.

What is covered:

All labor and material expenses for covered items, but you must pay any shipping charges if it is necessary to ship the product to Bluesound/Lenbrook or to an authorized Bluesound dealer or Distributor. If the repairs are covered by the warranty, Bluesound/Lenbrook, the dealer or distributor will pay the return shipping charges.

What is not covered:

This warranty does not cover a component which has been:

1. Damaged in transit or by act of God;
2. Overloaded, abused, misused, or operated with faulty or unsuitable equipment, or contrary to instructions contained in the accompanying product manual;
3. Serviced by unauthorized personnel;
4. The serial number has been altered or removed.

IN NO EVENT SHALL THE WARRANTOR BE LIABLE FOR INCIDENTAL, OR CONSEQUENTIAL DAMAGES, whether damages resulting from breach of express or implied warranties, tort, negligence, or otherwise.

Some states (provinces) or countries do not allow exclusion or limitation of incidental or consequential damages so the above limitation or exclusion may not apply to you.

This warranty gives you specific legal rights, and you may also have other rights which vary from state (province) or between countries.

IMPORTANT: Warranty in some countries may vary. Contact Bluesound or your local distributor for details.

WARNING

DO NOT ENTRUST ANY REPAIR WORK TO UNAUTHORIZED PERSONS. THE COMPONENTS NECESSARY TO MAINTAIN THE ORIGINAL PERFORMANCE OF THIS PRODUCT ARE AVAILABLE ONLY THROUGH AUTHORIZED DEALERS AND DISTRIBUTORS. THE WARRANTY WILL BE INVALIDATED IF THE EQUIPMENT IS TAMPERED WITH OR INCORRECT PARTS ARE SUBSTITUTED.