

Chair

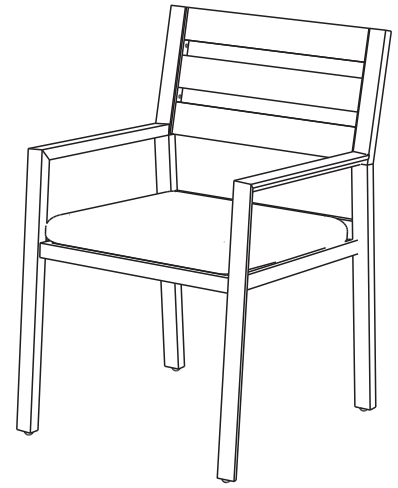

IMPORTANT

Carefully remove all the parts from the carton and place them individually on a soft cloth to prevent scratches or other damage.

Carefully and strictly follow these assembly instructions to ensure a completed product as designed.

This product is made of aluminum. Do not use power tools above 8 volts to assemble and only tighten bolts until snug. Over tightening can damage the aluminum.

Part List

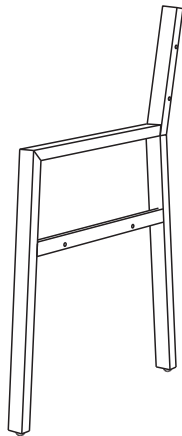

A.
Side
1 pc.

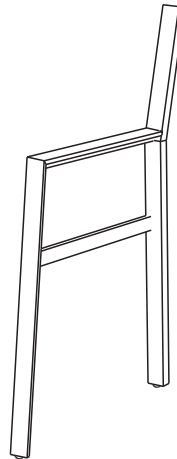

B.
Side
1 pc.

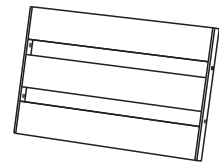

C.
Back
1 pc.



D.
Seat
1 pc.



E.
Cushion
1 pc.

Hardware List

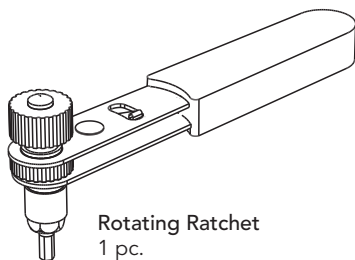

Rotating Ratchet
1 pc.

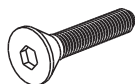

01
Head Cap Bolt (tapered)
4 pcs. (+1 extra)

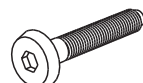

02
Head Cap Bolt
4 pcs. (+1 extra)



03
Spring Washer
4 pcs. (+1 extra)



04
Flat Washer
4 pcs. (+1 extra)



05
Cap
4 pcs. (+1 extra)

Tool(s) required for assembly: Level

homestyles Customer Service: www.homestylesfurniture.com,
servicedesk@homestylesfurniture.com, 888-680-7460

Assembly Instructions 2/3

IMPORTANT

- Use a soft cloth between these parts and the floor.
- Do not use power tools above 8 volts to assemble.
- Do not tighten all the bolts until each part is properly assembled.
- Keep Rotating Ratchet as the bolts may need to be tightened in the future.

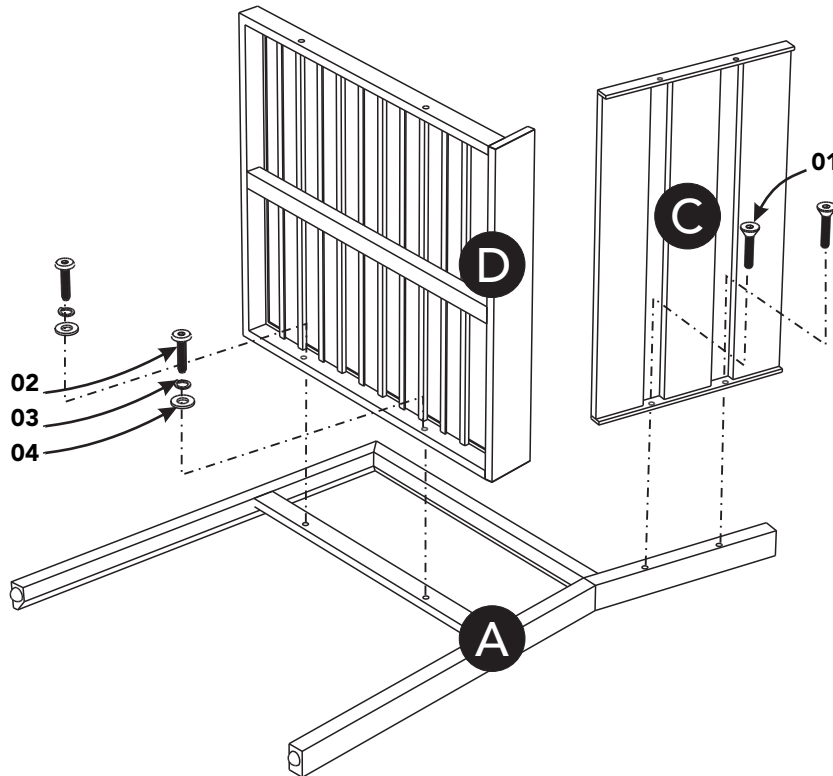

STEP 1

Attach Back (C) to Side (A) with 2 pcs. of **01**, tightening **01** only halfway by using Rotating Ratchet.

Note: Rotating Ratchet button is in tighten position.
(See Figures 1 and 2)

Attach Seat (D) to Side (A) with 2 pcs. of **02**, **03** and **04**, tightening **02** only halfway.
(See Figure 3)

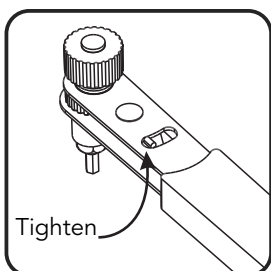

Figure 1

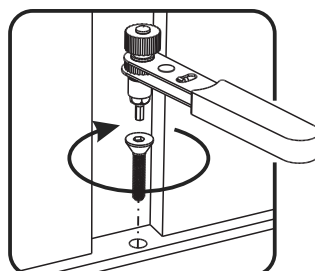

Figure 2

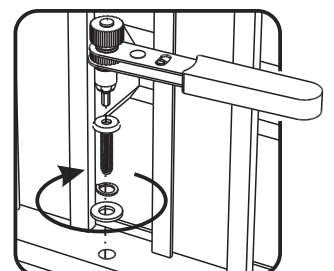

Figure 3

Assembly Instructions 3/3

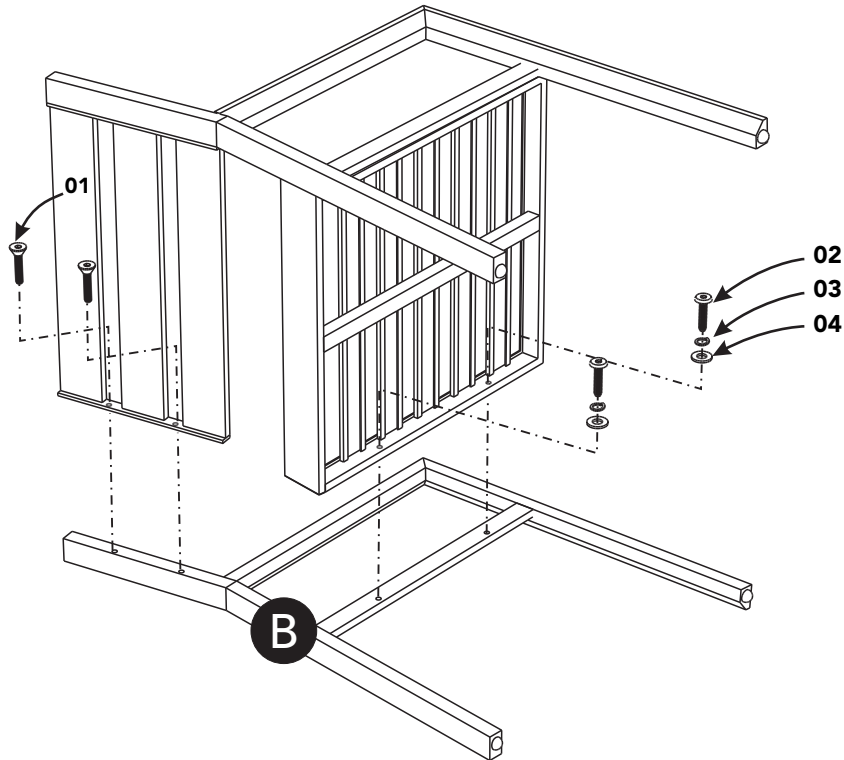

Figure 4

STEP 2

Attach unit to Side (B) with 2 pcs. of **01**, **02**, **03** and **04**, tightening **01** and **02** only halfway.

Tighten up all of **01** and **02**.

Cover 4 pcs. of **02** with **05**. (See Figure 4)

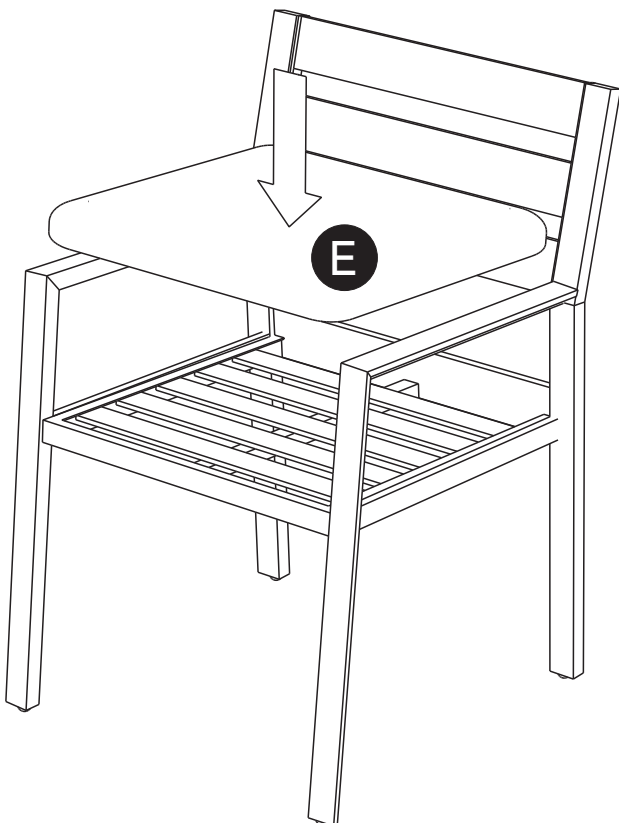

STEP 3

Turn unit to its upright position.

Level chair by adjusting the adjustable levelers on bottom of legs. (See Figure 5)

Place Cushion (E) into position.

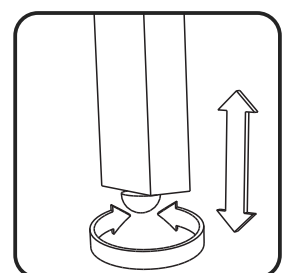

Figure 5

CARE INSTRUCTIONS

NEVER

allow liquids to remain on furniture.
Absorption causes parts to warp
and split and finishes to delaminate.

NEVER

use glass cleaners on
finished furniture. Ammonia
chemically attacks the finish.



Do not use power tools
above 8 volts to assemble.

**PREVENT
CRACKING**



Do not write
directly on surface.

**PREVENT
MARKING**

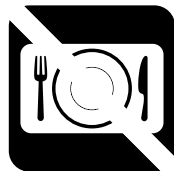

Do not use rubber
based placemats.

**PREVENT
DISCOLORING**



Do not place hot
objects on surface.

**PREVENT
FINISH DAMAGE**



Do not use commercial
waxes and polishes.

**PREVENT
YELLOWING**

CLEAN

with a soft cloth moistened
in lukewarm soap and water.
Buff with a dry clean cloth.



homestyles will provide replacements free of charge for missing or damaged parts within 2 years of purchase. Digital images of the defective parts may be required. If the product was not purchased from an authorized retailer, **homestyles** is under no obligation to provide replacement parts. Parts are not available for fully assembled items nor are parts available for sale. Replacements for missing or damaged parts may be requested via contact info below.

homestyles Customer Service: www.homestylesfurniture.com,
servicedesk@homestylesfurniture.com, 888-680-7460