

IMPORTANT

Carefully remove all the parts from the carton and place them individually on a soft cloth to prevent scratches or other damage.

Carefully and strictly follow these assembly instructions to ensure a completed product as designed.

Do not use power tools above 8 volts to assemble.

Part List

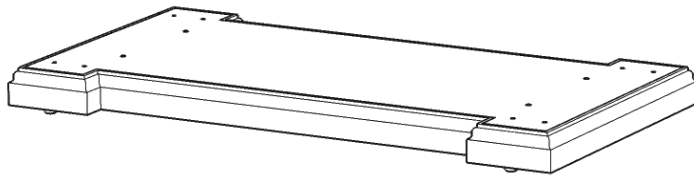

E.
Base
1 pc.



H.
Rail
2 pcs.



F.
Shelf
2 pcs.

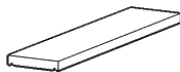

G.
Shelf
4 pcs.



I.
Upright
1 pc.

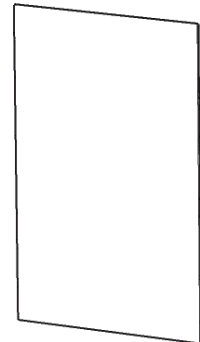

J.
Back Panel
2 pcs.

Hardware List



Hex Wrench
1 pc.



Cam Lock Screw
4 pcs. (+1 extra)



M6x35
Head Cap Bolt
12 pcs. (+1 extra)



Knob
4 pcs.



Small Hex Wrench
1 pc.



Cam Lock
4 pcs. (+2 extra)



Adjustable Pin
24 pcs. (+1 extra)



M4x25
Machine Screw
4 pcs.



M6x16
Wood Screw
9 pcs. (+1 extra)

Carton 20 05104 0941 and 0943 are also needed for assembly.

Tool(s) required for assembly: Phillips screwdriver, Level

Home Styles Customer Service: www.homestyles-furniture.com,
 servicedesk@homestyles-furniture.com, 888-680-7460, 877-831-0319

Assembly Instructions 2/5

IMPORTANT

- Use a soft cloth between these parts and the floor.
- Do not use power tools above 8 volts to assemble.
- Do not tighten all the bolts until each part is properly assembled.
- The unit must be level to work properly. Use the included adjustable levelers to level.
- Keep Hex Wrench as the bolts may need to be tightened in the future.

STEP 1

Insert Cam Lock Screws into pre-drilled holes in Side Panels (C) and (D), then tighten. (See Figure 1)

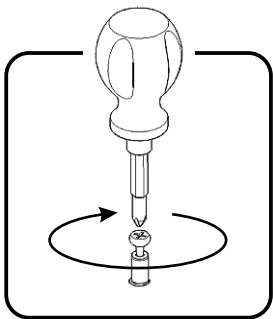

Figure 1

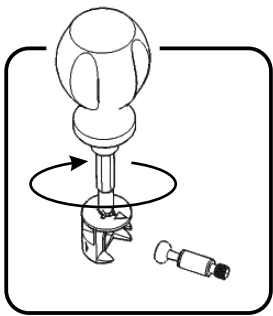
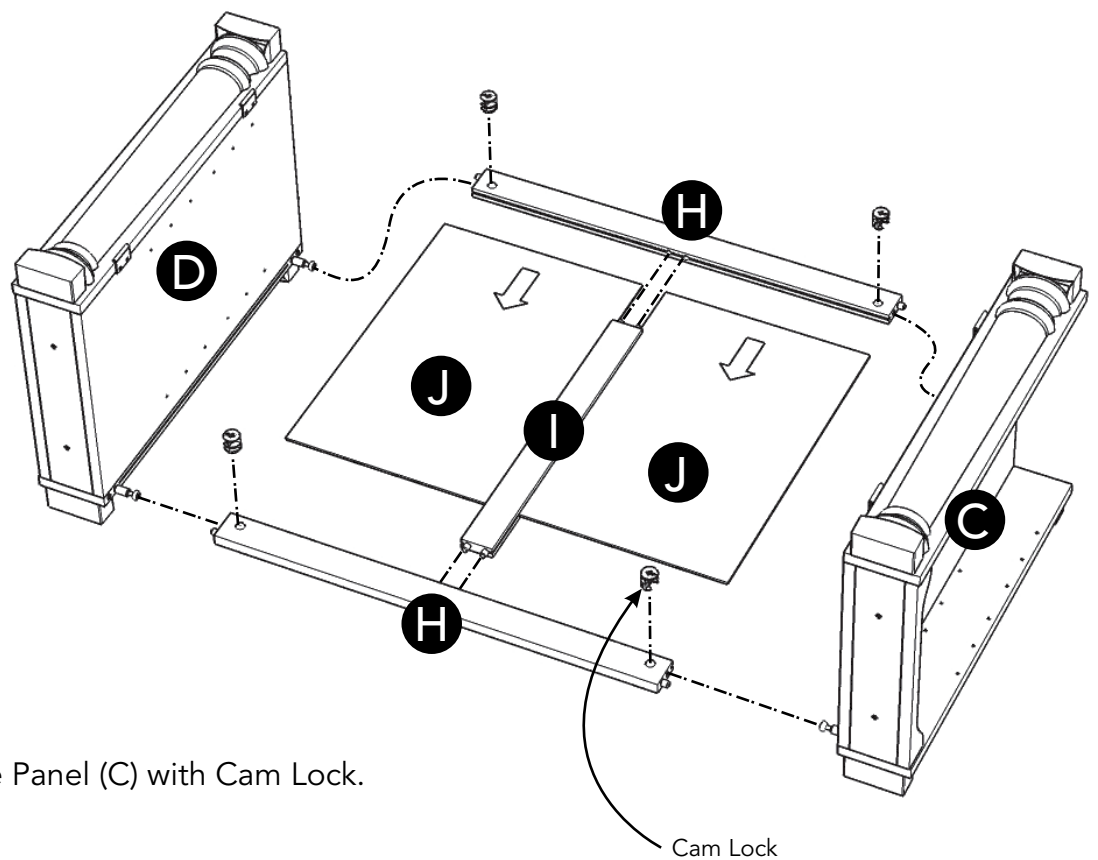
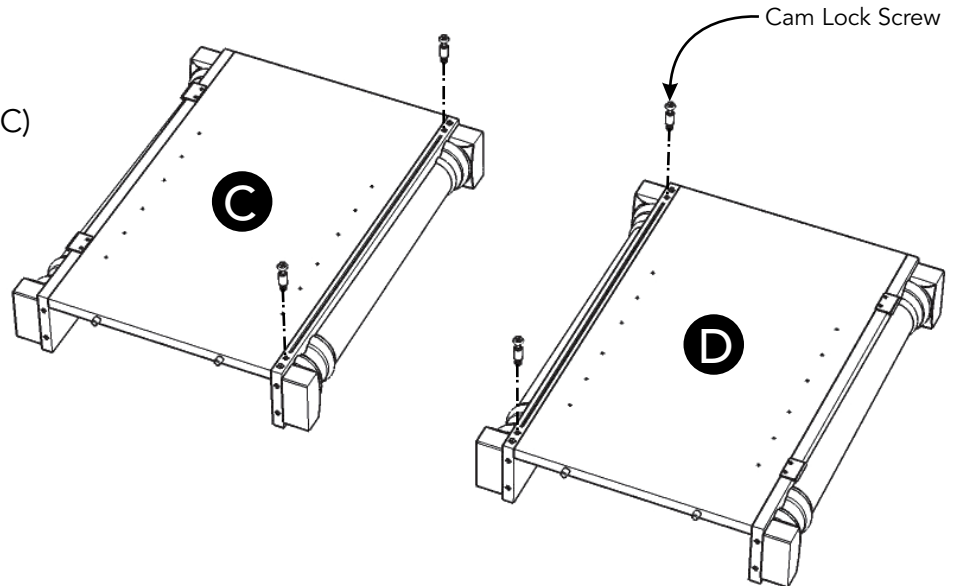

Figure 2



STEP 2

Attach Rail (H) to Side Panel (C) with Cam Lock. (See Figure 2)

Attach Upright (I) to unit.

Slide Back Panels (J) into position.

Attach Rail (H) to unit with Cam Lock.

Attach Side Panel (D) to unit with Cam Locks.

Assembly Instructions 3/5

STEP 3

Attach Base (E) to unit with Head Cap Bolts. (See Figure 3)

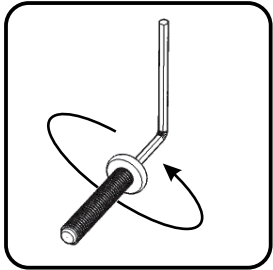
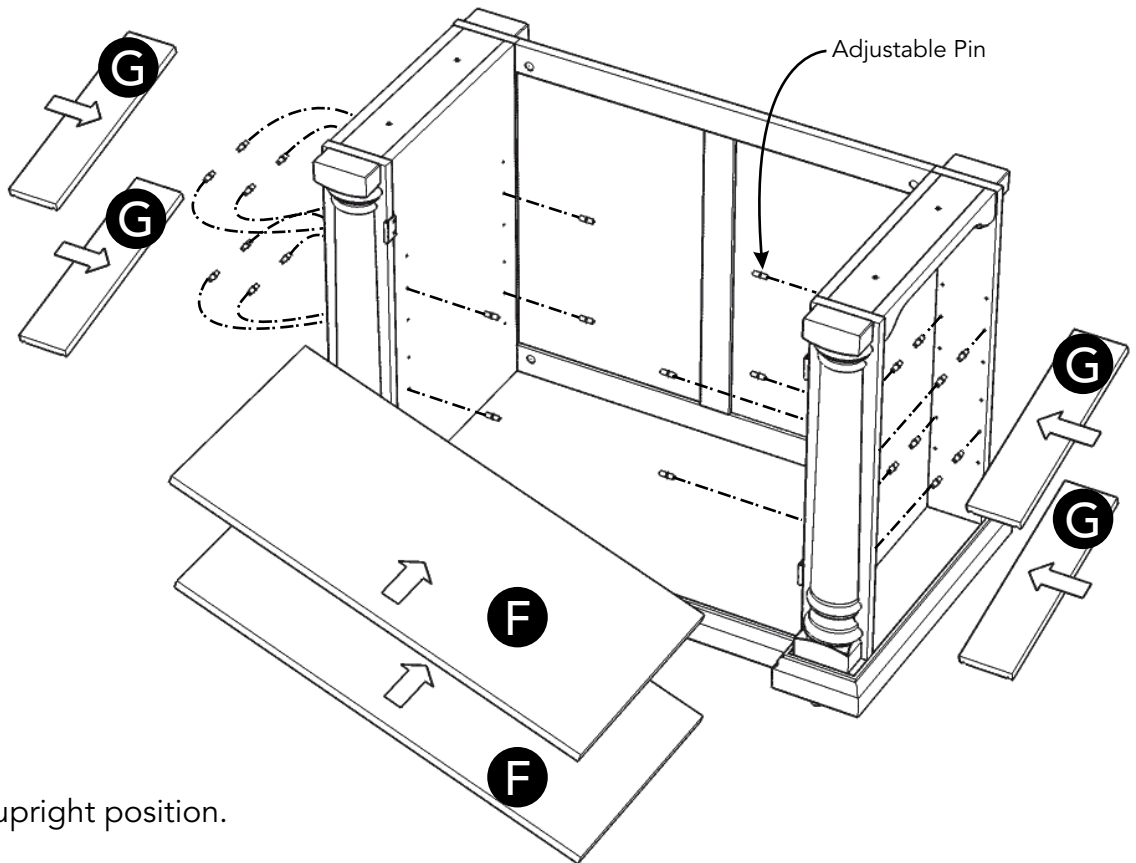
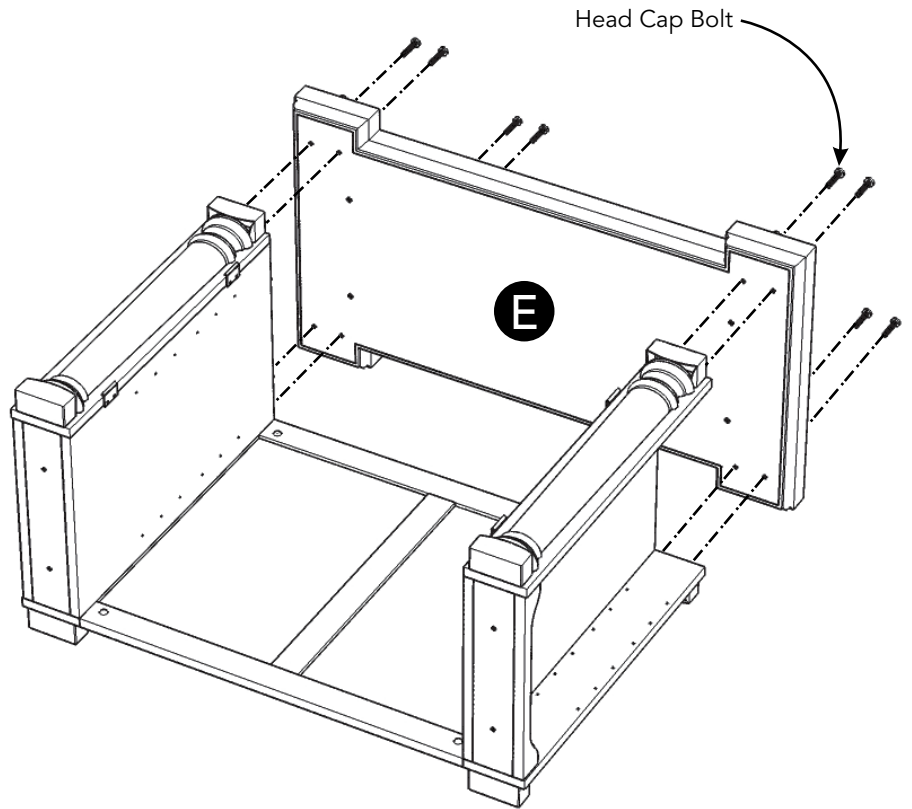

Figure 3



STEP 4

Turn unit to its' upright position.

Insert Adjustable Pins into side panels at desired level.

Place Shelves (F) and (G) into position.

STEP 5

Attach Doors (K) and (L) to unit by sliding door hinges into side panel hinges. (See Figure 4)

Attach Knobs to Doors (K) and (L) with Machine Screws. (See Figure 5)

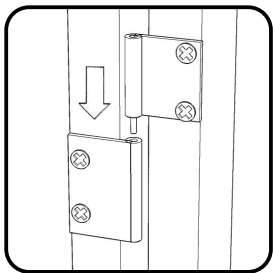

Figure 4

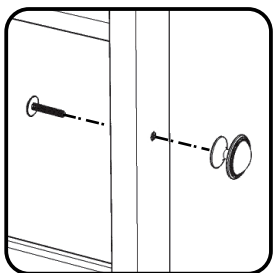

Figure 5

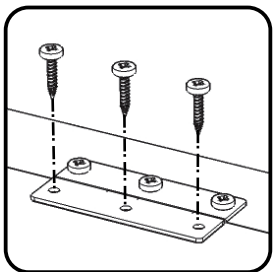
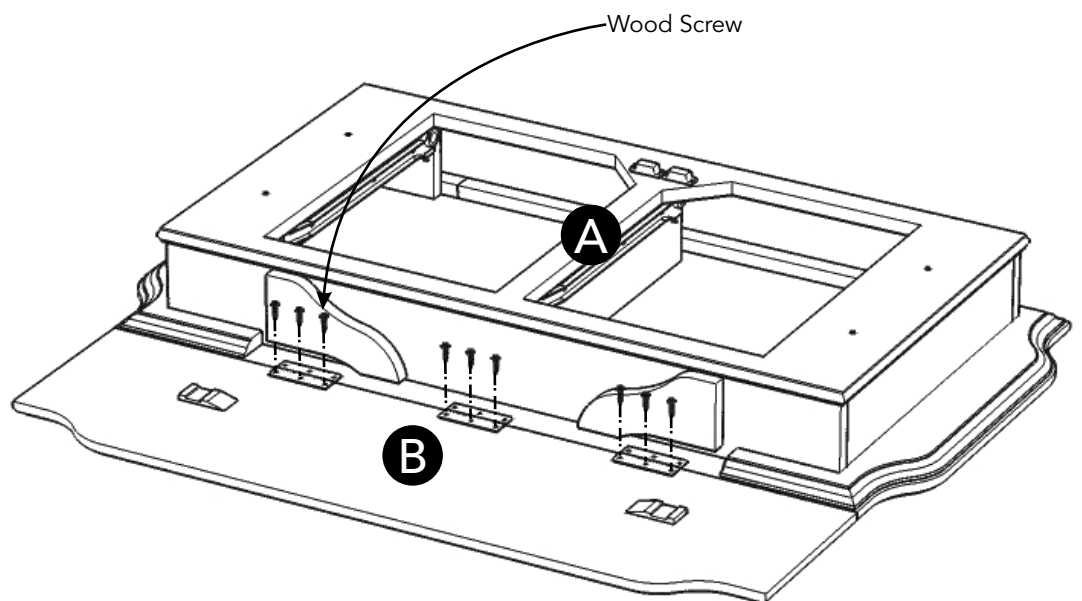
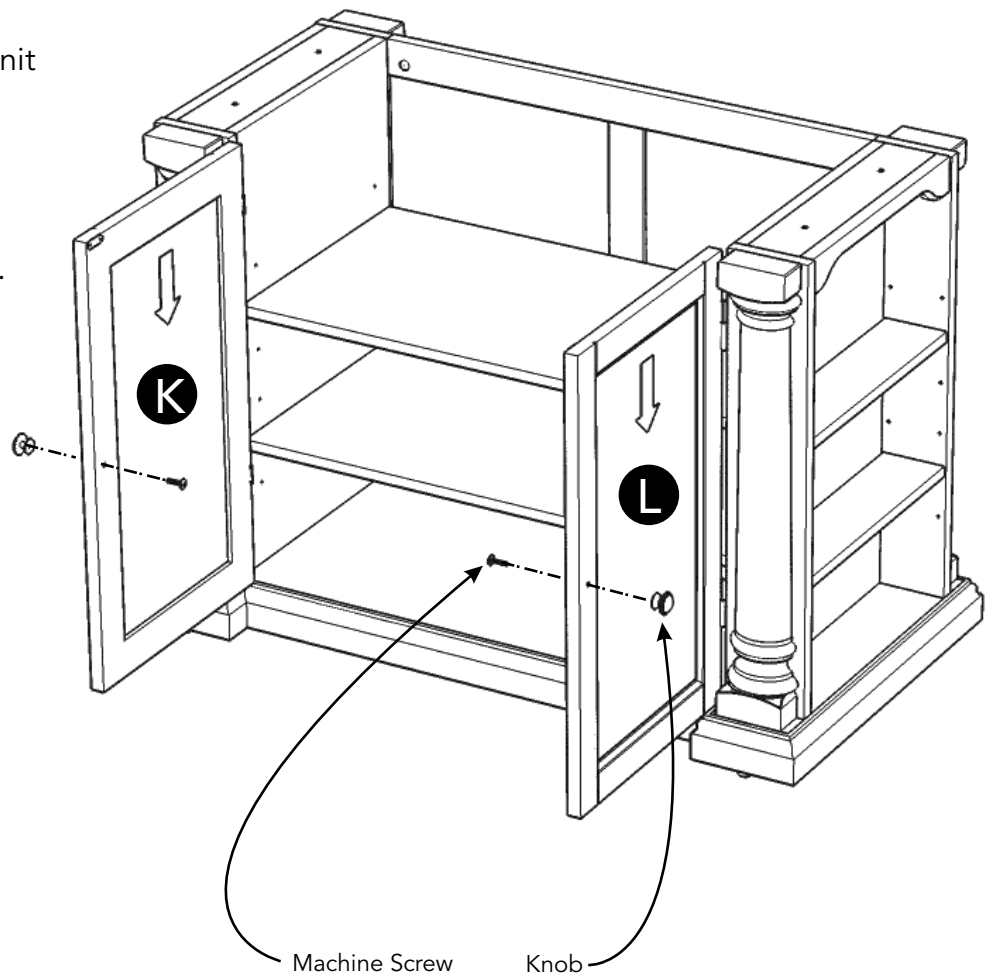

Figure 6



STEP 6

Remove drawers from Top Unit (A).

Place Top Unit (A) and Leaf (B) upside down on a soft cloth.

Attach Leaf (B) to Top Unit (A) with Wood Screws. (See Figure 6)

Assembly Instructions 5/5

STEP 7

Attach top unit to unit from Step 5 with Head Cap Bolts.

Level unit by adjusting the adjustable levelers on bottom of unit. (See Figure 7)

Note: Unit must be level to work properly.

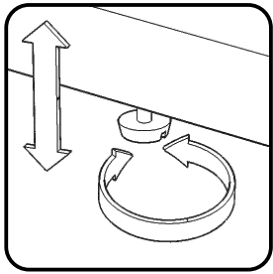
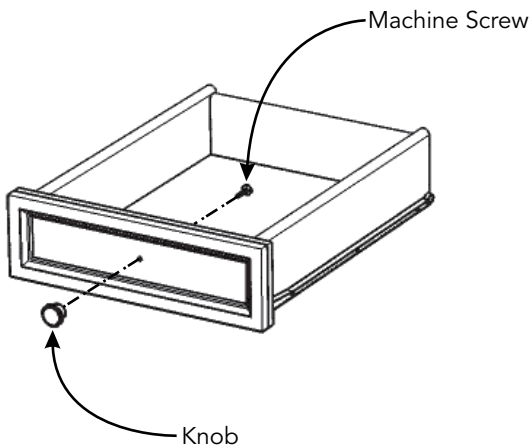
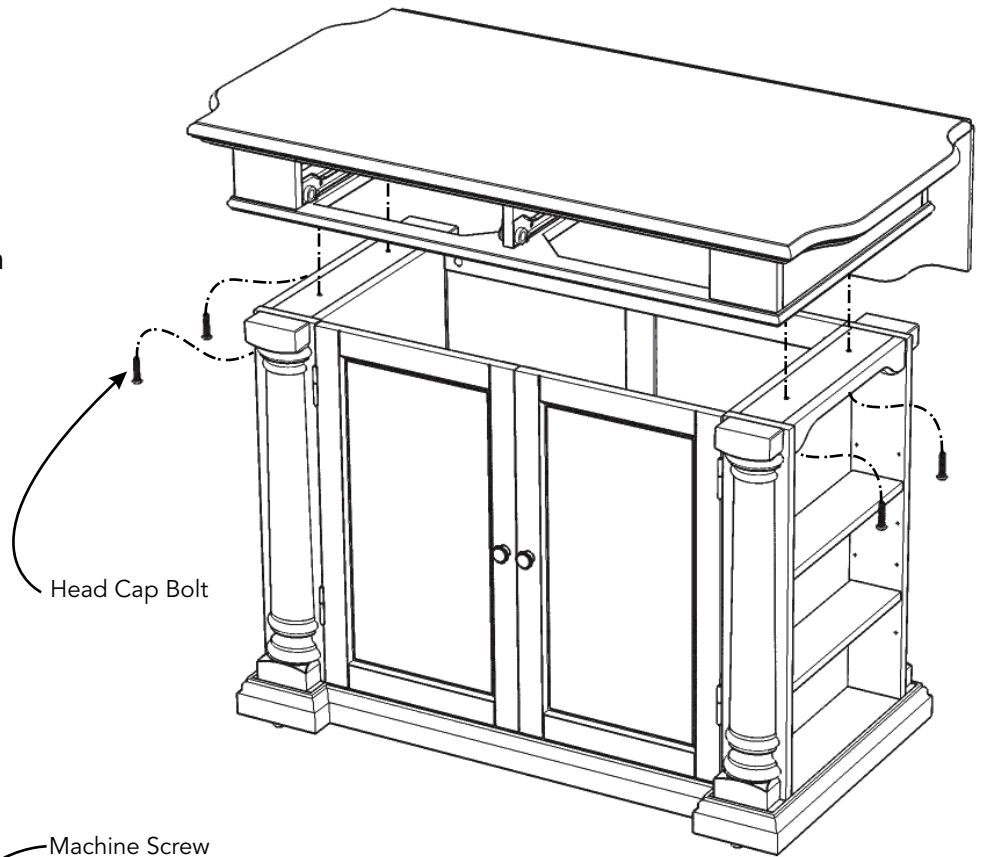

Figure 7



STEP 8

Attach Knobs to drawers with Machine Screws.

STEP 9

Slide drawers into position.



CARE INSTRUCTIONS

NEVER

allow liquids to remain on furniture.
Absorption causes parts to warp
and split and finishes to delaminate.

NEVER

use glass cleaners on
finished furniture. Ammonia
chemically attacks the finish.



Do not use power tools
above 8 volts to assemble.
**PREVENT
CRACKING**



Do not place
in direct sunlight.
**PREVENT
FADING**



Do not write
directly on surface.
**PREVENT
MARKING**



Do not place hot
objects on surface.
**PREVENT
FINISH DAMAGE**

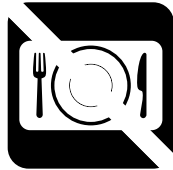

Do not use rubber
based placemats.
**PREVENT
DISCOLORING**



Do not use commercial
waxes and polishes.
**PREVENT
YELLOWING**

CLEAN

with a soft cloth moistened
in lukewarm soap and water.
Buff with a dry clean cloth.



Home Styles will provide replacements free of charge for missing or damaged hardware or parts within 30 days of purchase. Digital images of the defective parts may be required. If the product was not purchased from an authorized retail affiliate, Home Styles is under no obligation to provide replacement parts. Parts are not available for fully assembled items nor are parts available for sale. Replacements for missing or damaged hardware or parts may be requested at:

www.homestyles-furniture.com/customer-service/replacement-parts

Home Styles Customer Service: www.homestyles-furniture.com,
servicedesk@homestyles-furniture.com, 888-680-7460, 877-831-0319