

TRAC-MASTER®

Two Circuit Track System

TRACK SECTION, JOINERS & FEEDS

TU Series

Project: _____

Fixture Type: _____

Location: _____

Contact/Phone: _____

PRODUCT DESCRIPTION

Low profile, two-circuit track sections for surface or pendant mounting. Provides two separate 20-amp circuits from a single electrical feed or one 20-amp circuit controlled by two switches. I-beam cross section provides added strength and rigidity in pendant suspended applications. Compatible with a full range of feed, connector and mounting accessories, as listed on back of this page, to complete virtually any installation requirement. Accepts all Trac-Master and Trac-Lites track fixtures, which have a moveable "hot" contact to allow operation using circuit (or switch leg) 1 or 2.

PRODUCT SPECIFICATIONS

Construction Extruded aluminum "I" beam channel • One-piece thermoplastic insulator • Injection molded polycarbonate dead-end with set screw • Standard lengths may be cut-to-length by installer.

Electrical Three 12 gauge solid copper conductors • Each circuit rated 20 amps at 120 volts (40 amps total) • Aluminum channel used as system ground • One-piece insulator insures consistent conductor spacing for reliable electrical contact • Insulating bushings supplied at mounting hole locations to prevent shorts to ground.

Labels UL listed, CSA certified.

Buy American This product is assembled in the USA and meets the Buy America(n) government procurement requirements under FAR, DFARS and DOT. Please refer to www.acuitybrands.com/buy-american for additional information.

PRODUCT INSTALLATION

Debossed polarity line provides visual cue to proper track, track connector and fixture alignment • Supplied with toggle bolts for surface mounting • Integral raceway in top of channel accommodates pendant mounting hardware and wire routing to electrical feed • Insulator stays same length as extrusion to simplify field-cutting of track • Connectors and feeds simply push into track sections.

WARRANTY 1-year limited warranty. This is the only warranty provided and no other statements in this specification sheet create any warranty of any kind. All other express and implied warranties are disclaimed. Complete warranty terms located at: www.acuitybrands.com/support/warranty/terms-and-conditions.

Note: Actual performance may differ as a result of end-user environment and application.

Specifications subject to change without notice.

DIMENSIONS

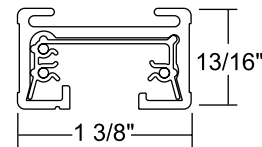
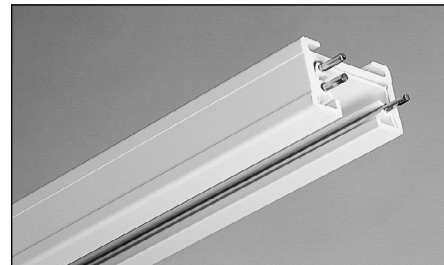

INSTALLATION GUIDE

Use two switches for greater control, two circuits for greater capacity.

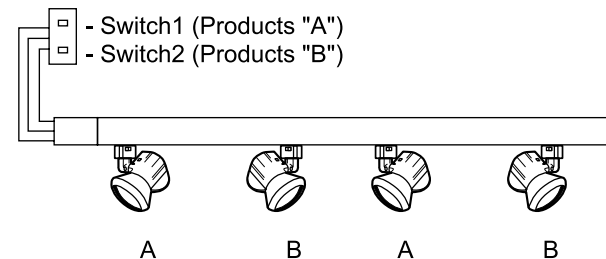

Where wattage requirements are 2400W or more, the track run may be fed from one point, providing 4800W capacity plus 2 switches.

One Circuit with Two Switches - 2400W Max.

Two switches may be used on each track run with a portion of track fixtures run by Switch 1 and the balance on Switch 2

- Dimmers, occupancy sensors, timers, etc. can also be utilized to provide other lighting effects along the run.

Two Circuits with Two Switches - 4800W Max.

Two-Circuit Trac-Master provides a load capacity of 4800W

(two 2400 watt circuits) using split phase common neutral circuit

- This "double capacity" eliminates 50% of the feed points in long runs reducing wiring costs and simplifying the installation

- Two separate circuit switches permit flexibility in combining lighting effects along the run.

ORDERING INFORMATION

Example: TU 8FT WH

Series	Length	Finish
TU Trac-Master 2-Circuit Track Sections	2FT 2-foot track section; actual length 19-7/8"	BL Black
	4FT 4-foot track section; actual length 43-7/8"	SL Silver
	6FT 6-foot track section; actual length 67-7/8"	WH White
	8FT 8-foot track section; actual length 91-7/8"	
	12FT 12-foot track section; actual length 139-7/8"	

TRAC-MASTER®

Two Circuit Track System

TRACK SECTION, JOINERS & FEEDS

TU Series

Electrical Feeds

Examples: TU21 BL, TU34 RP WH

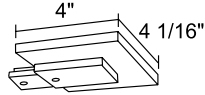
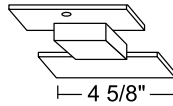
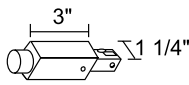
TU21 BL, SL, WH	TU21 RP BL, SL, WH	TU29 BL, SL, WH	TU34 BL, SL, WH	TU34 RP BL, SL, WH
<p>End Feed Connector and Outlet Box Cover</p> <p>For outlet box feed. Includes: outlet box cover, fixture strap and ground screw.</p> 	<p>End Feed Connector and Outlet Box Cover</p> <p>Same as TU21 except designed for use in opposite polarity orientation compared to standard feed connectors.</p>	<p>Floating Electrical Feed</p> <p>Permits mounting any point of track under outlet box. Includes floating connector, outlet box cover plus extra track dead end.</p> 	<p>Conduit End Feed</p> <p>For surface wiring. Use standard 1/2" connector.</p> 	<p>Conduit End Feed</p> <p>Same as TU34 except designed for use in opposite polarity orientation compared to standard feed connectors.</p>

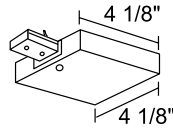
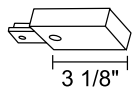
TU36 BL, SL, WH	TU36 RP BL, SL, WH	TU38 BL, SL, WH	TU38 RP BL, SL, WH
<p>T-Bar End Feed</p> <p>Wiring compartment contains standard 1/2" KO's. Feeds surface track from above, when T-bar is directly above track.</p> 	<p>T-Bar End Feed</p> <p>Same as TU36 except designed for use in opposite polarity orientation compared to standard feed connectors.</p>	<p>Live End Feed Connector</p> <p>Feed track from above with flexible conduit, BX, etc., or end feed in pendant systems.</p> 	<p>Live End Feed Connector</p> <p>Same as TU38 except designed for use in opposite polarity orientation compared to standard feed connectors.</p>

TRAC-MASTER®

Two Circuit Track System



TRACK SECTION, JOINERS & FEEDS

TU Series

Track Joiners & Dead End

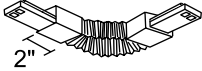
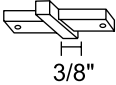
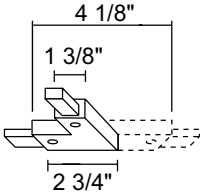
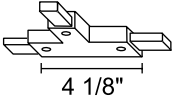
Examples: TU20 BL, TU25 RP WH

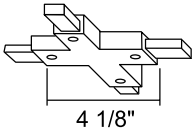
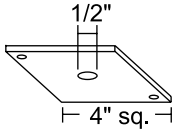
TU20 BL, SL, WH	TU23 BL, SL, WH	TU24 ‡ BL, SL, WH	TU25 ‡ BL, SL, WH	TU25 RP ‡ BL, SL, WH
<p>Accordion Adjustable Joiner</p> <p>Can flex to 90° angle to left, right, up or down. Joins two track sections.</p> 	<p>Miniature Straight Connector</p> <p>Joins two track sections end to end.</p> 	<p>Adjustable Connector</p> <p>Joins two track sections to make a 90° angle or straight run. Straight and right angle covers supplied. For outlet box feed, T27 cover plate required.</p> 	<p>"T" Connector</p> <p>Joins three track sections. For outlet box feed, T27 cover plate required.</p> 	<p>"T" Connector</p> <p>Same as TU25 except designed for use in opposite polarity orientation compared to standard feed connectors.</p>

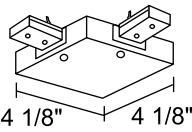
TU26 ‡ BL, SL, WH	T27 BL, SL, WH	TU28 BL, SL, WH	TU35 BL, SL, WH
<p>"X" Connector</p> <p>Joins four track sections at 90° angles. For outlet box feed, T27 cover plate required.</p> 	<p>Outlet Box Cover</p> <p>Use with TU24/TU25/TU26 for outlet box electrical feed. Includes: nipple, locknut and ground screw.</p> 	<p>Dead End</p> <p>For use with field-cut track sections.</p> 	<p>T-Bar Adjustable Joiner Feed</p> <p>Joins two track sections to make 90° angle or straight run. Wiring compartment contains standard 1/2" KO's. Feeds from above when T-bar is directly above track.</p> 

‡ TU24, TU25 and TU26 may not be used as feed connectors in Canada.

TRAC-MASTER®

Two Circuit Track System





TRACK SECTION, JOINERS & FEEDS

TU Series

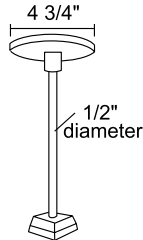
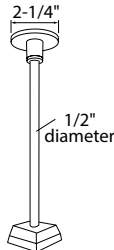
Pendant Stems

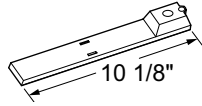
Examples: T90 12IN BL, T93 BL

T90	T91	T9091M
12IN, 18IN, 24IN, 36IN, 48IN	12IN, 18IN, 24IN, 36IN, 48IN	12IN, 18IN, 24IN, 36IN, 48IN
BL, SL, WH	BL, SL, WH	BL, SL, WH
<p>T-Bar Pendant Stem Kit</p> <p>Compatible with 15/16" flush T-Bar ceilings. 4' max. spacing. Track sections must be supported within 6" of any connection point. Typically requires 2 per 2' or 4' track, 3 per 6' or 8' track, or 4 per 12' track. More supports, spaced closer together, may be required when installing heavier or unbalanced luminaires. Includes canopy, T-Bar mounting plate, stem and track attachment hardware. For electrical feed, order T93 wireway cover. Stems need to be rethreaded if cut in the field.</p> 	<p>Rigid Ceiling Pendant Stem Kit</p> <p>Attaches directly to junction box in rigid ceilings. 4' max. spacing. Track sections must be supported within 6" of any connection point. Typically requires 2 per 2' or 4' track, 3 per 6' or 8' track, or 4 per 12' track. More supports, spaced closer together, may be required when installing heavier or unbalanced luminaires. Includes canopy, J-Box mounting strap, stem and track attachment hardware. For electrical feed, order T93 wireway cover. Stems need to be rethreaded if cut in the field.</p>	<p>Pendant Stem Mechanical Support Kit</p> <p>For mechanical support only (no feed). Suspends track from T-bar or rigid ceilings. 4' max. spacing. Track sections must be supported within 6" of any connection point. Typically requires 2 per 2' or 4' track, 3 per 6' or 8' track, or 4 per 12' track. More supports, spaced closer together, may be required when installing heavier or unbalanced luminaires. Includes Mini-Canopy, pendant stem, 15/16" T-bar clip, drywall anchor and track mounting hardware. Stems need to be rethreaded if cut in the field.</p> 

T93	T94	T96	T56
BL, SL, WH	BL, SL, WH	BL, SL, WH	BL, SL, WH
<p>Wireway Cover</p> <p>For Pendant Stem Kits T90 and T91. Conceals electrical feed wires from stem to connector. One cover required for each track feed.</p> 	<p>Sloped Ceiling Adapter</p> <p>Allows T90, T91, or T9091M pendant stem to hang straight down from sloped ceilings. Can be used to feed electrical wires to track at up to 60° angle.</p> 	<p>Pendant Stem Threaded Coupling</p> <p>Enables multiple pendant stems to be joined for higher ceiling applications.</p> 	<p>Solid Rod Pendant Mounting Kit</p> <p>Attaches solid 5/16" threaded rod to track. Includes: plastic cap, mounting bracket and hardware. Rod not supplied.</p> 

TRAC-MASTER®

Two Circuit Track System

TRACK SECTION, JOINERS & FEEDS

TU Series

Cable Suspension

Examples: T595 48IN BL, TU598 144IN WH

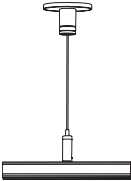
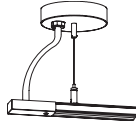
T595	T597	TU596	TU598
48IN, 144IN	48IN, 144IN	48IN, 144IN	48IN, 144IN
BL, WH	BL, WH	BL, WH	BL, WH
<p>T-Bar Ceiling Cable Suspension Kit</p> <p>Mechanical-only cable suspension kit for 1-circuit or 2-circuit track. Compatible with 15/16" flush T-Bar ceilings. 4' max. spacing. Track sections must be supported within 6" of any connection point unless T92 or T92L Structural Bridges are used. Typically requires 2 per 2' or 4' track, 3 per 6' or 8' track, or 4 per 12' track. More supports, spaced closer together, may be required when installing heavier or unbalanced luminaires. Adjustable 48" or 144" stainless steel cable length. Includes mini-canopy, T-bar clip and cable hardware.</p> 	<p>Rigid Ceiling Cable Suspension Kit</p> <p>Mechanical-only cable suspension kit for 1-circuit or 2-circuit track. Attaches directly to junction box in rigid ceilings. 4' max. spacing. Track sections must be supported within 6" of any connection point unless T92 or T92L Structural Bridges are used. Typically requires 2 per 2' or 4' track, 3 per 6' or 8' track, or 4 per 12' track. More supports, spaced closer together, may be required when installing heavier or unbalanced luminaires. Adjustable 48" or 144" stainless steel cable length. Includes mini-canopy, toggle bolt and cable hardware.</p>	<p>T-Bar Ceiling Cable Suspension/Feed Kit</p> <p>Cable suspension kit with adjustable 48" or 144" electrical feed cable for 2-circuit track. Compatible with 15/16" flush T-Bar ceilings. 4' max. spacing. Track sections must be supported within 6" of any connection point unless T92 or T92L Structural Bridges are used. Typically requires 2 per 2' or 4' track, 3 per 6' or 8' track, or 4 per 12' track. More supports, spaced closer together, may be required when installing heavier or unbalanced luminaires. Includes canopy, T-bar clip, mounting plate, cable hardware and flexible electrical feed cable. Track feed connector not included (order separately).</p> 	<p>Rigid Ceiling Cable Suspension/Feed Kit</p> <p>Cable suspension kit with adjustable 48" or 144" electrical feed cable for 2-circuit track. Attaches directly to junction box in rigid ceilings. 4' max. spacing. Track sections must be supported within 6" of any connection point unless T92 or T92L Structural Bridges are used. Typically requires 2 per 2' or 4' track, 3 per 6' or 8' track, or 4 per 12' track. More supports, spaced closer together, may be required when installing heavier or unbalanced luminaires. Includes canopy, J-box mounting strap, cable hardware and flexible electrical feed cable. Track feed connector not included (order separately).</p>

Note: Cable suspension is recommended for pattern installations only, or those installations that are supplemented with additional rigid mounting points (stems, threaded rod, etc.).

TRAC-MASTER®



Two Circuit Track System



TRACK SECTION, JOINERS & FEEDS

TU Series

Accessories

Example: T31N BL

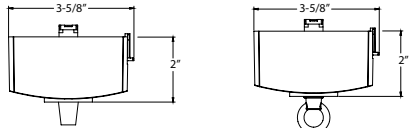
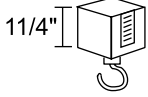
T37F	T37D	T37F916	T37D916
<p>15/16" T-Bar Attachment Clip</p> <p>To attach to inverted tee ceilings using flush tiles. Use two for 2' or 4' track, or three for 6' or 8' of track, or four for 12' of track (4' max. spacing).</p> 	<p>15/16" T-Bar Attachment Clip</p> <p>Same as T37F with spacer for ceilings using drop tiles.</p>	<p>9/16" T-Bar Attachment Clip</p> <p>To attach to inverted tee ceilings using flush or drop tiles. Use two for 2' or 4' track, or three for 6' or 8' of track, or four for 12' of track (4' max. spacing).</p> 	<p>9/16" T-Bar Attachment Clip</p> <p>Same as T37F916 with spacer for ceilings using drop tiles.</p>

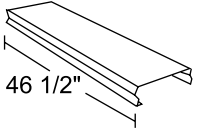
T31N BL, SL, WH	T32 BL, WH	T33 BL, SL, WH	T39 BL
<p>Pendant Adapter</p> <p>Adapts corded, swag or chain-hung fixture to track. Includes loop hook for chain installation and strain relief for direct cord suspension. Chain installation accepts cord diameters up to 0.270" and supports up to 15 lbs. Strain relief installation accepts cord diameters of 0.170" to 0.255", type SVT 18/3, and supports up to 5 lbs. May also be specified with GTYPE, HTYPE or LTYPE Alternate Mounting Adapters (i.e. T31N HTYPE WH). 5A max. UL Listed. Not available in HTYPE BL.</p> 	<p>Plant or Utility Hook</p> <p>Supports up to 25 lbs. Not UL Listed.</p> 	<p>Outlet Adapter</p> <p>Provides electrical receptacle. Not UL Listed.</p> 	<p>Wireway Cover</p> <p>4' black thermoplastic extrusion, covers wire carried in track wireway. Use one for 4' track, two for 8' track, and three for 12' track. Can be field cut.</p> 

Note: GTYPE, HTYPE and LTYPE available in BL or WH finishes only.

TRAC-MASTER®

Two Circuit Track System

TRACK SECTION, JOINERS & FEEDS

TU Series

Example Track Configurations & Recommended Components (Top Plan View)

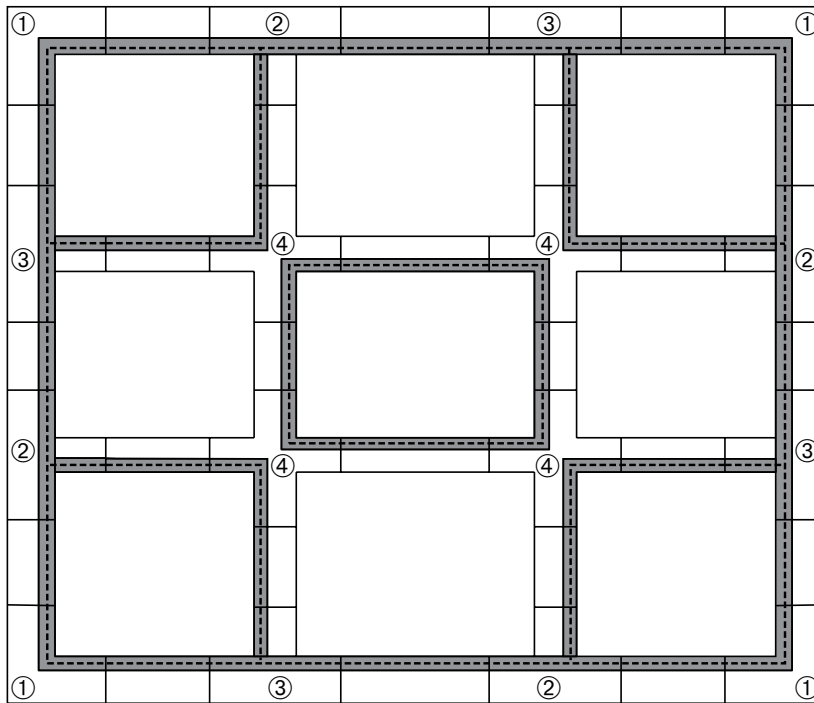
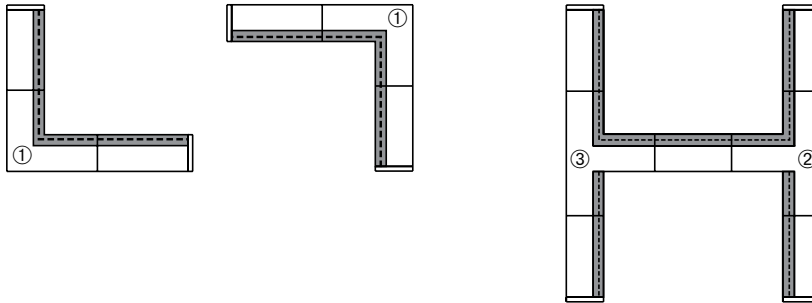

- ① Standard "L" Connector – **TU24**
- ② Standard "T" Connector – **TU25**
- ③ Reverse Polarity "T" Connector – **TU25 RP**
- ④ Standard "X" Connector – **TU26**
- ⑤ Standard End Feed Connector – **TU38** (or similar End Feed)
- ⑥ Reverse Polarity End Feed Connector – **TU38 RP** (or similar Reverse Polarity End Feed)

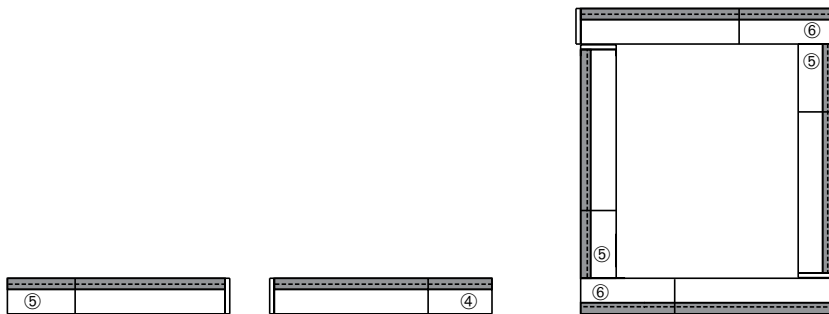

(Each run controlled by separate feeds)