











# ASSEMBLY INSTRUCTION

ITEM# 5300-90867 6/6-6/0 Upholstered Mantle Panel Headboard  
 5300-90868 6/6-6/0 Panel Footboard  
 5300-90869 6/6 Panel Rails  
 5300-90863 6/0 Panel Rails

**Caution: Please make sure you have all parts indicated below prior to assembly.  
 This bed is heavy and can best be assembled with the help of two or more persons.**

NO.	HARDWARE LIST		Q'TY
E		NUT	8
F		SPANNER WRENCH	1
G		CURVED WASHER	8
H		FULL THREADED BOLT	8
K		SCREW	20
R		4MM ALLEN WRENCH	1
Q		BOLT	10
V		LOCK WASHER	10
U		FLAT WASHER	10
M		5MM ALLEN WRENCH	1

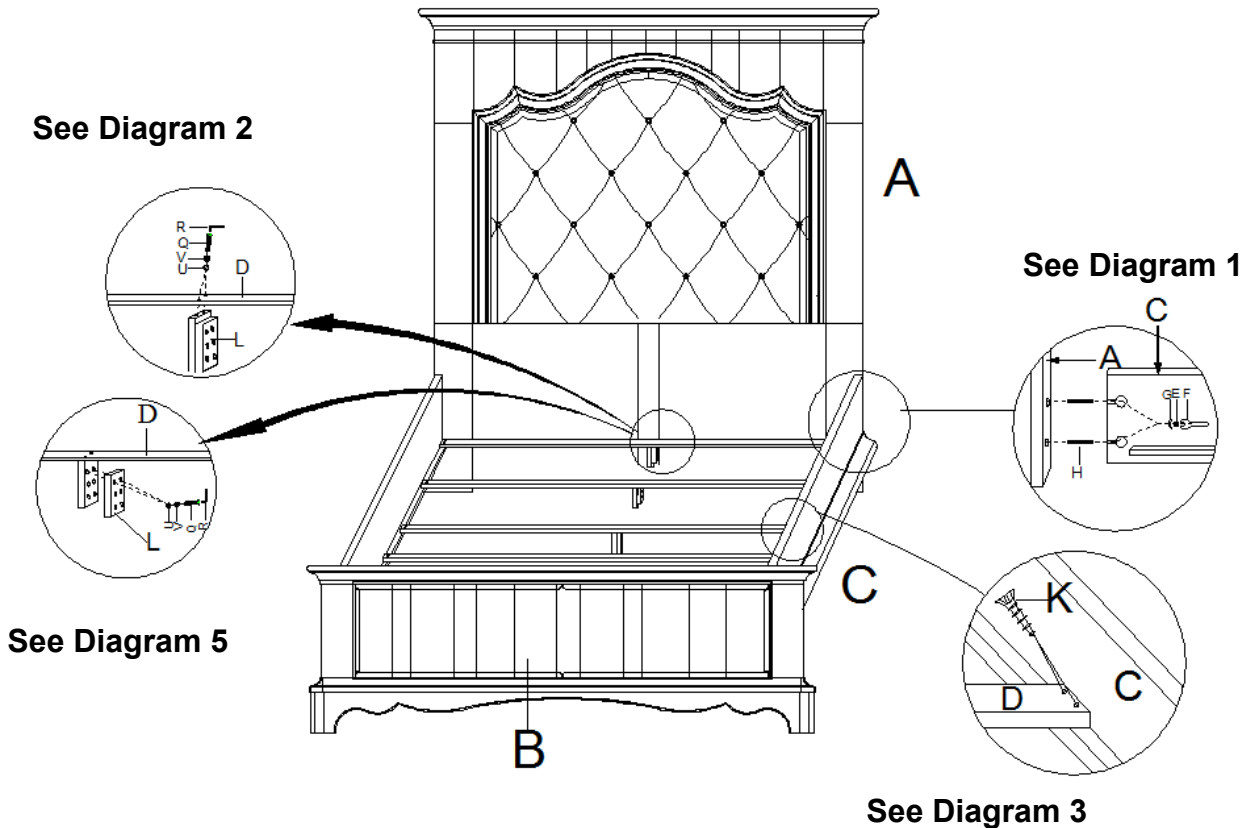

Please note the hardware bag to assemble side rails to HB&FB is in the box of side rails.

### Assembly steps:

1. Insert 2 bolts (H) into holes of each side post on Headboard (A) and Footboard (B), attach the end of side rails (C) to bolts (H) on posts by using 2 curved washers (G) and 2 nuts (E), tighten nuts (E) securely with spanner wrench (F). (See diagram 1)

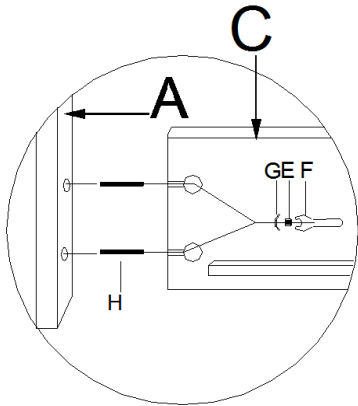

**Diagram 1**

2. Take out center supports (L) from the rail box, attach center supports (L) to slats by using 2 bolts (Q), 2 lock washers (V) and 2 flat washers (U). Secure bolts (Q) by using allen wrench (R). (See diagram 2)

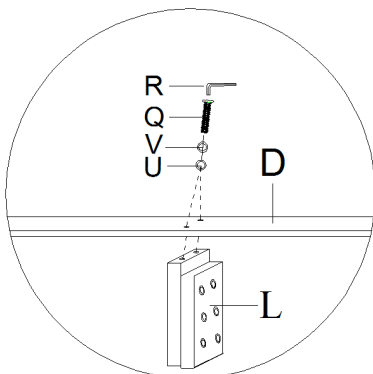

**Diagram 2**

- 3 Attach slats (D) to side rails (C), align pre-drilled holes on the slat to holes on the cleat of side rail (C), using screws (K) to tighten both. (See diagram 3)

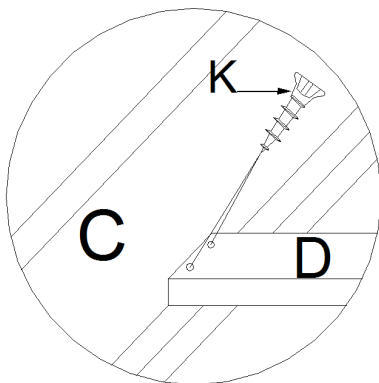

**Diagram 3**

Note: You can change the height of slat by adjusting the height of cleat on side rail as shown in diagram 4. Remove bolt (I), lock washer (O) and flat washer (J) from the cleat by turning the bolt (I) with allen wrench (M) in anti-clockwise direction. Adjust the cleat to a desired position, and then secure lock washer, flat washer, bolt in a clockwise direction by turning with allen wrench.

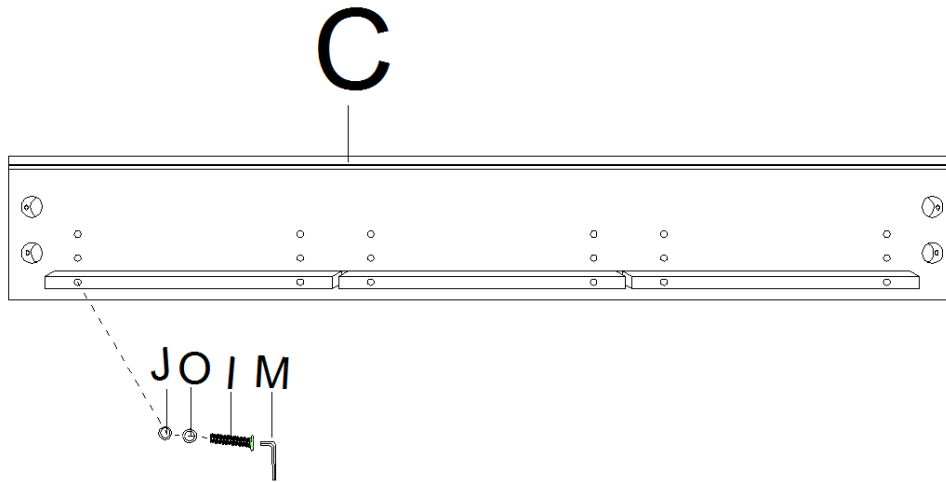

**Diagram 4**

You can adjust the height of center supports (L) as shown in Diagram 5 to meet your need by the following steps.

1. Unscrew bolts on center supports (L) with allen wrench (R).
2. Adjust the height of center supports, align the holes on 2pcs of woods and tighten them together with 2 bolts (Q), 2 lock washers (V) and 2 flat washers (U) by turning with allen wrench (R) in a clockwise direction.

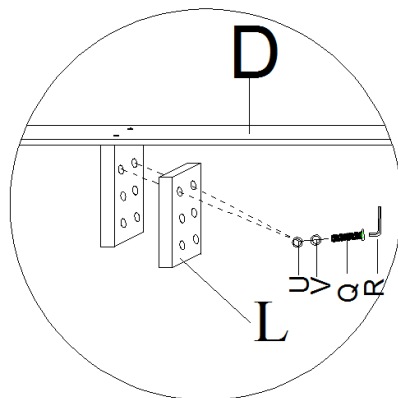

**Diagram 5**

**Cleaning Instruction:** Clean finished parts with a mild dishwashing liquid and water solution on a damp cloth. Polish the finish with soft cloth and an industry recognized furniture polish.