

TYPICAL BASE SHOE ELEVATION W/ HANDRAIL

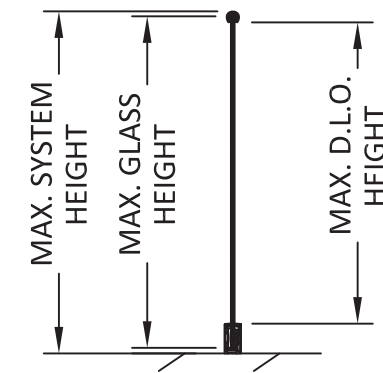

TYPICAL VERTICAL SECTION

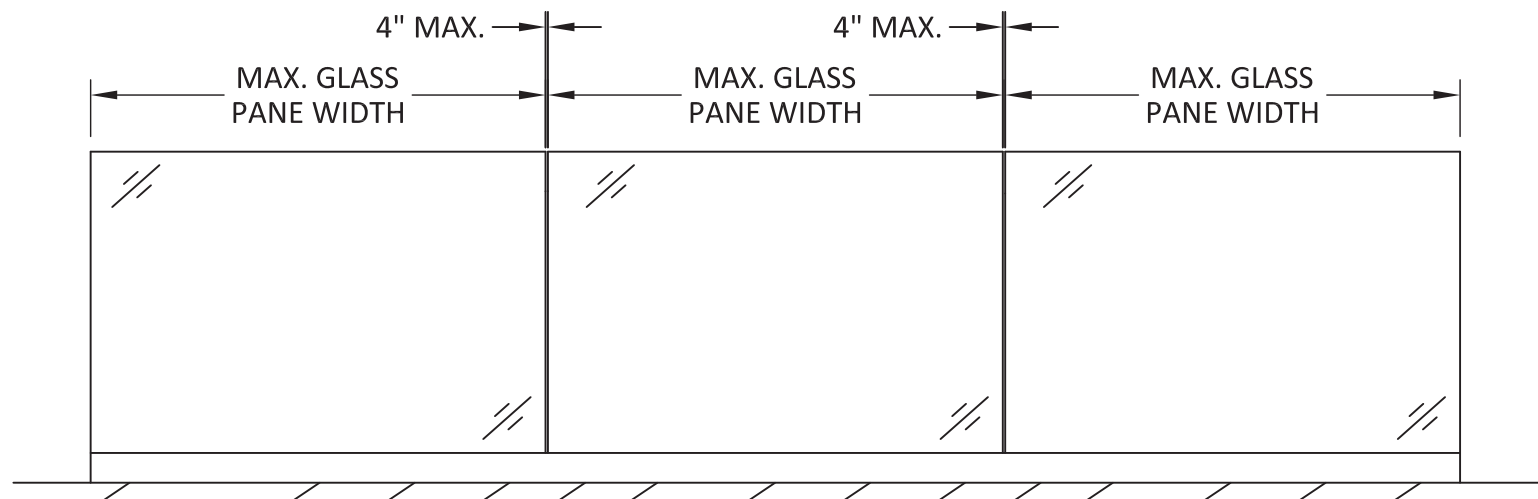

TYPICAL BASE SHOE ELEVATION W/O HANDRAIL

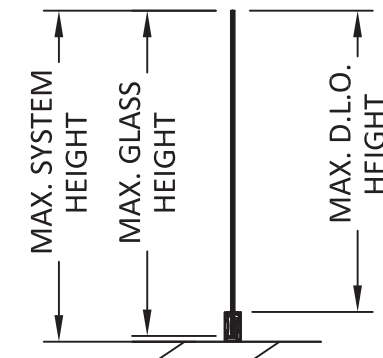

TYPICAL VERTICAL SECTION

NOTE: SEE SHEETS 3 & 4 FOR DESIGN PRESSURE TABLES AND SHEETS 5 & 6 FOR ANCHOR DETAILS.



TYPICAL TOP VIEW

FUTUREGLASS

GLASSWAREHOUSE

FUTUREGLASS
GLASS WAREHOUSE
1319 ROCKY POINT DRIVE, SUITE 200
OCEANSIDE, CA 92056
PH: (760) 536-3640

TITLE: RANA - MODEL RAN-CHRES
GLASS BASESHOE RAILING

ELEVATIONS

PREPARED BY:
BUILDING DROPS, INC.

1900 NE MIAMI COURT, STE. 2-15
MIAMI, FL 33132
PH: (954)399-8478
FAX: (954)744.4738
WEB: www.buildingdrops.com



REMARKS	BY	DATE

THE INSTALLATION DETAILS DESCRIBED HEREIN ARE GENERIC AND MAY NOT REFLECT ACTUAL CONDITIONS FOR A SPECIFIC SITE. IF SITE CONDITIONS CAUSE INSTALLATION TO DEVIATE FROM THE REQUIREMENTS DETAILED HEREIN, A LICENSED ENGINEER OR ARCHITECT SHALL PREPARE SITE SPECIFIC DOCUMENTS FOR USE WITH THIS DOCUMENT.

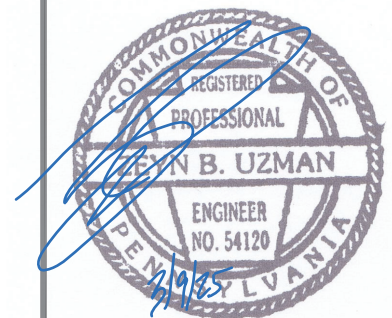

BUILDING DROPS, INC
1900 NE MIAMI COURT, STE. 2-15
MIAMI, FL 33132
FBPE CERT. OF AUTHORIZATION No. 29578

DATE: 10.30.24

DWG. BY: DI

CHK. BY: HFN

SCALE: NTS

DWG. #: GLW002

SHEET:

2

OF 9

ALLOWABLE WIND LOAD TABLES BASED ON GLASS TYPE

TABLE 1: 1/2" MONOLITHIC TEMPERED GLASS

GLASS WIDTH (in.)	ALLOWABLE WIND LOAD (PSF)					
	GLASS HEIGHT (in.)					
	36	39.75	42	48	60	72
12	59.67	48.52	42.92	31.76	19.77	11.15
24	48.25	39.14	34.71	25.78	16.09	9.05
36	39.64	32.38	28.70	21.36	13.36	7.61
42	39.64	32.38	25.24	18.85	11.80	6.72
48	39.64	32.38	25.24	16.56	10.41	5.88
60	39.64	32.38	25.24	16.56	8.51	4.86
72	39.64	32.38	25.24	16.56	8.51	4.09

TABLE 2: 7/16" O.A. LAMINATED GLASS: 3/16" TEMPERED GLASS - 0.060" PVB - 3/16" TEMPERED GLASS

GLASS WIDTH (in.)	ALLOWABLE WIND LOAD (PSF)					
	GLASS HEIGHT (in.)					
	36	39.75	42	48	60	72
12	24.78	20.33	18.21	13.94	8.92	6.20
24	29.02	23.80	21.32	16.32	10.45	7.25
36	34.31	28.14	25.20	19.30	12.35	8.58
42	34.31	28.14	27.14	20.78	13.30	9.23
48	34.31	28.14	27.14	22.18	14.19	9.86
60	34.31	28.14	27.14	22.18	15.77	10.95
72	34.31	28.14	27.14	22.18	15.77	11.84

TABLE 3: 7/16" O.A. LAMINATED GLASS: 3/16" TEMPERED GLASS - 0.060" PVB ES - 3/16" TEMPERED GLASS

GLASS WIDTH (in.)	ALLOWABLE WIND LOAD (PSF)					
	GLASS HEIGHT (in.)					
	36	39.75	42	48	60	72
12	28.41	23.30	20.87	15.98	10.23	7.10
24	38.22	31.35	28.08	21.50	13.76	9.55
36	46.14	37.84	33.90	25.95	16.61	11.53
42	46.14	37.84	36.01	27.57	17.65	12.25
48	46.14	37.84	36.01	28.86	18.47	12.83
60	46.14	37.84	36.01	28.86	19.65	13.65
72	46.14	37.84	36.01	28.86	19.65	14.18

TABLE 4: 7/16" O.A. LAMINATED GLASS: 3/16" TEMPERED GLASS - 0.060" SENTRYGLAS - 3/16" TEMPERED GLASS

GLASS WIDTH (in.)	ALLOWABLE WIND LOAD (PSF)					
	GLASS HEIGHT (in.)					
	36	39.75	42	48	60	72
12	43.16	35.40	31.71	24.28	15.54	10.79
24	54.98	45.09	40.39	30.93	19.79	13.74
36	58.88	48.30	43.26	33.12	21.20	14.72
42	58.88	48.30	43.96	33.66	21.54	14.96
48	58.88	48.30	43.96	34.02	21.78	15.12
60	58.88	48.30	43.96	34.02	22.06	15.32
72	58.88	48.30	43.96	34.02	22.06	15.43

FUTUREGLASS

GLASSWAREHOUSE

FUTUREGLASS
GLASS WAREHOUSE
1319 ROCKY POINT DRIVE, SUITE 200
OCEANSIDE, CA 92056
PH: (760) 536-3640

TITLE: RAMA - MODEL RAN-CHRES
GLASS BASESHOE RAILING

GLASS ALLOWABLE DESIGN
PRESSURE TABLES

PREPARED BY: BUILDING DROPS, INC.

1900 NE MIAMI COURT, STE. 2-15
MIAMI, FL 33132
PH: (954)399-8478
FAX: (954)744-4738
WEB: www.buildingdrops.com



REMARKS	BY	DATE

THE INSTALLATION DETAILS DESCRIBED HEREIN ARE GENERIC AND MAY NOT REFLECT ACTUAL CONDITIONS FOR A SPECIFIC SITE. IF SITE CONDITIONS CAUSE INSTALLATION TO DEVIATE FROM THE REQUIREMENTS DETAILED HEREIN, A LICENSED ENGINEER OR ARCHITECT SHALL PREPARE SITE SPECIFIC DOCUMENTS FOR USE WITH THIS DOCUMENT.

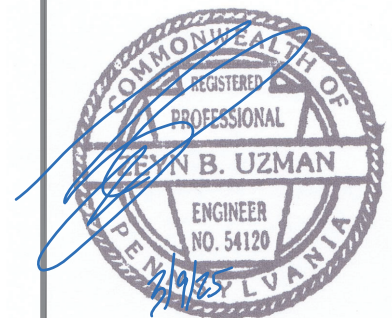

BUILDING DROPS, INC.
1900 NE MIAMI COURT, STE. 2-15
MIAMI, FL 33132
FBPE CERT. OF AUTHORIZATION No. 29578

DATE: 10.30.24

DWG. BY: DI CHK. BY: HFN

SCALE: NTS

DWG. #: GLW002

SHEET: 3

OF 9

c:\users\ybanivara\building_drops, inc\building_drops, inc\projects\glass_warehouse, inc\ev-24-0946.1 - engineering evaluation - base shoe system and posted glass railing\dwgs\base shoe\other states\glw002 - ibc.dwg 1/30/2025 11:20 AM

ALLOWABLE WIND LOAD TABLES BASED ON GLASS TYPE

FUTUREGLASS

GLASSWAREHOUSE

FUTUREGLASS
GLASS WAREHOUSE
1319 ROCKY POINT DRIVE, SUITE 200
OCEANSIDE, CA 92056
PH: (760) 536-3640

TABLE 5: 9/16" O.A. LAMINATED GLASS: 1/4" TEMPERED GLASS - 0.090" PVB - 1/4" TEMPERED GLASS

GLASS WIDTH (in.)	ALLOWABLE WIND LOAD (PSF)					
	GLASS HEIGHT (in.)					
	36	39.75	42	48	60	72
12	36.06	29.58	26.49	20.29	12.98	9.02
24	40.87	33.52	30.03	22.99	14.71	10.22
36	47.18	38.70	34.67	26.54	16.99	11.80
42	47.18	38.70	37.07	28.38	18.17	12.61
48	47.18	38.70	37.07	30.17	19.31	13.41
60	47.18	38.70	37.07	30.17	21.41	14.87
72	47.18	38.70	37.07	30.17	21.41	16.10

TABLE 8: 11/16" O.A. LAMINATED GLASS: 5/16" TEMPERED GLASS - 0.090" PVB - 5/16" TEMPERED GLASS

GLASS WIDTH (in.)	ALLOWABLE WIND LOAD (PSF)					
	GLASS HEIGHT (in.)					
	36	39.75	42	48	60	72
12	63.02	51.69	46.30	35.45	22.69	15.75
24	68.89	56.51	50.62	38.75	24.80	17.22
36	77.07	63.21	56.62	43.35	27.74	19.27
42	77.07	63.21	59.90	45.86	29.35	20.38
48	77.07	63.21	59.90	48.39	30.97	21.51
60	77.07	63.21	59.90	48.39	34.09	23.67
72	77.07	63.21	59.90	48.39	34.09	25.61

TABLE 6: 9/16" O.A. LAMINATED GLASS: 1/4" TEMPERED GLASS - 0.090" PVB ES - 1/4" TEMPERED GLASS

GLASS WIDTH (in.)	ALLOWABLE WIND LOAD (PSF)					
	GLASS HEIGHT (in.)					
	36	39.75	42	48	60	72
12	40.17	32.95	29.51	22.59	14.46	10.04
24	52.09	42.73	38.27	29.30	18.75	13.02
36	62.68	51.41	46.05	35.26	22.56	15.67
42	62.68	51.41	49.06	37.56	24.04	16.69
48	62.68	51.41	49.06	39.45	25.25	17.53
60	62.68	51.41	49.06	39.45	27.03	18.77
72	62.68	51.41	49.06	39.45	27.03	19.60

TABLE 9: 11/16" O.A. LAMINATED GLASS: 5/16" TEMPERED GLASS - 0.090" PVB ES - 5/16" TEMPERED GLASS

GLASS WIDTH (in.)	ALLOWABLE WIND LOAD (PSF)					
	GLASS HEIGHT (in.)					
	36	39.75	42	48	60	72
12	68.01	55.79	49.97	38.26	24.49	17.00
24	83.81	68.75	61.58	47.14	30.17	20.95
36	99.70	81.78	73.25	56.08	35.89	24.93
42	99.70	81.78	78.16	59.84	38.30	26.60
48	99.70	81.78	78.16	63.07	40.36	28.03
60	99.70	81.78	78.16	63.07	43.57	30.26
72	99.70	81.78	78.16	63.07	43.57	31.82

TABLE 7: 9/16" O.A. LAMINATED GLASS: 1/4" TEMPERED GLASS - 0.090" SENTRYGLAS - 1/4" TEMPERED GLASS

GLASS WIDTH (in.)	ALLOWABLE WIND LOAD (PSF)					
	GLASS HEIGHT (in.)					
	36	39.75	42	48	60	72
12	58.59	48.06	43.05	32.96	21.09	14.65
24	75.69	62.08	55.61	42.58	27.25	18.92
36	81.89	67.17	60.16	46.06	29.48	20.47
42	81.89	67.17	61.31	46.94	30.04	20.86
48	81.89	67.17	61.31	47.54	30.43	21.13
60	81.89	67.17	61.31	47.54	30.90	21.46
72	81.89	67.17	61.31	47.54	30.90	21.65

TABLE 10: 11/16" O.A. LAMINATED GLASS: 5/16" TEMPERED GLASS - 0.090" SENTRYGLAS - 5/16" TEMPERED GLASS

GLASS WIDTH (in.)	ALLOWABLE WIND LOAD (PSF)					
	GLASS HEIGHT (in.)					
	36	39.75	42	48	60	72
12	93.34	76.56	68.57	52.50	33.60	23.33
24	122.15	100.19	89.75	68.71	43.98	30.54
36	134.21	110.08	98.60	75.49	48.31	33.55
42	134.21	110.08	100.95	77.29	49.46	34.35
48	134.21	110.08	100.95	78.54	50.27	34.91
60	134.21	110.08	100.95	78.54	51.27	35.60
72	134.21	110.08	100.95	78.54	51.27	36.00

TITLE: RAMA - MODEL RAN-CHRES
GLASS BASESHOE RAILING

GLASS ALLOWABLE DESIGN
PRESSURE TABLES

PREPARED BY:
BUILDING DROPS, INC.
1900 NE MIAMI COURT, STE. 2-15
MIAMI, FL 33132
PH: (954)399-8478
FAX: (954)744-4738
WEB: www.buildingdrops.com



REMARKS	BY	DATE

THE INSTALLATION DETAILS DESCRIBED HEREIN ARE GENERIC AND MAY NOT REFLECT ACTUAL CONDITIONS FOR A SPECIFIC SITE. IF SITE CONDITIONS CAUSE INSTALLATION TO DEVIATE FROM THE REQUIREMENTS DETAILED HEREIN, A LICENSED ENGINEER OR ARCHITECT SHALL PREPARE SITE SPECIFIC DOCUMENTS FOR USE WITH THIS DOCUMENT.

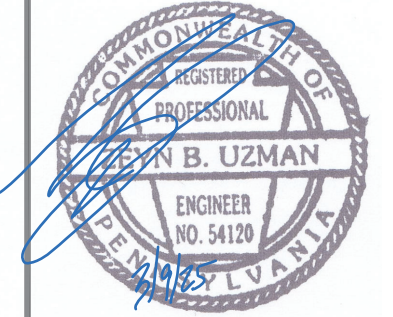

BUILDING DROPS, INC.
1900 NE MIAMI COURT, STE. 2-15
MIAMI, FL 33132
FBPE CERT. OF AUTHORIZATION No. 29578

DATE:	10.30.24
DWG. BY:	DI
CHK. BY:	HFN
SCALE:	NTS
DWG. #:	GLW002

SHEET:
4
OF 9

c:\users\y\anivara\building_drops, inc\building_drops, inc\projects\glass_warehouse, llc\rev-24-09\46.1 - engineering evaluation - base shoe system and posted glass railing\dwgs\base shoe system and posted glass railing\glw002 - fbc.dwg 1/30/2025 11:20 AM

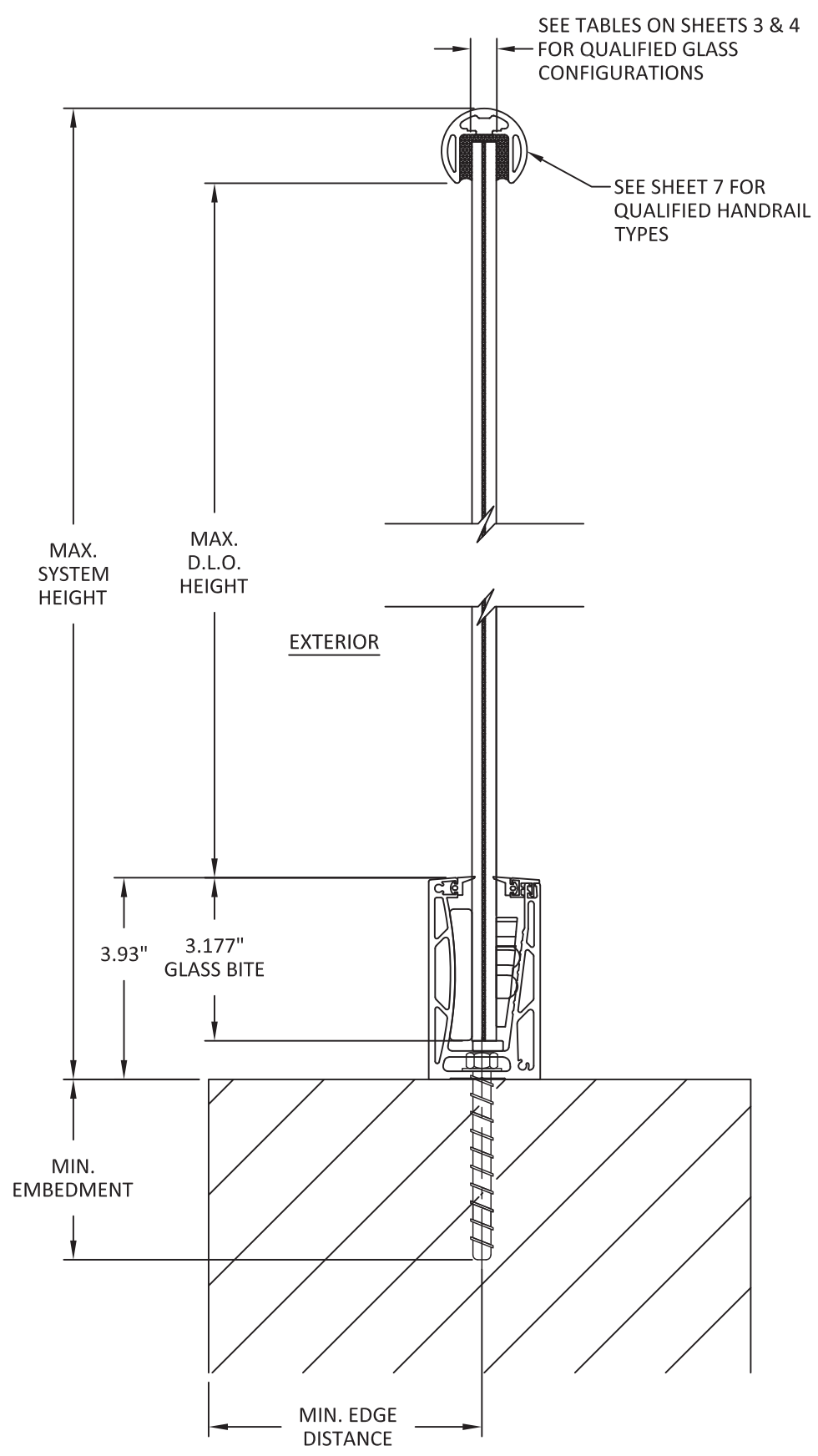

FUTUREGLASS

GLASSWAREHOUSE

FUTUREGLASS
GLASS WAREHOUSE
1319 ROCKY POINT DRIVE, SUITE 200
OCEANSIDE, CA 92056
PH: (760) 536-3640

TITLE: RANA - MODEL RAN-CHRES
GLASS BASESHOE RAILING

INSTALLATION DETAILS

PREPARED BY:
BUILDING DROPS, INC.
1900 NE MIAMI COURT, STE. 2-15
MIAMI, FL 33132
PH: (954)399-8478
FAX: (954)744.4738
WEB: www.buildingdrops.com



REMARKS	BY	DATE

THE INSTALLATION DETAILS DESCRIBED HEREIN ARE GENERIC AND MAY NOT REFLECT ACTUAL CONDITIONS FOR A SPECIFIC SITE. IF SITE CONDITIONS CAUSE INSTALLATION TO DEVIATE FROM THE REQUIREMENTS DETAILED HEREIN, A LICENSED ENGINEER OR ARCHITECT SHALL PREPARE SITE SPECIFIC DOCUMENTS FOR USE WITH THIS DOCUMENT.

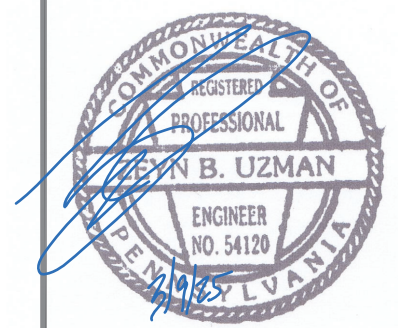

BUILDING DROPS, INC
1900 NE MIAMI COURT, STE. 2-15
MIAMI, FL 33132
FBPE CERT. OF AUTHORIZATION No. 29578

DATE: **10.30.24**

DWG. BY: **DI** CHK. BY: **HFN**

SCALE: **NTS**

DWG. #: **GLW002**

SHEET:
5
OF 9

ANCHOR TABLES

ANCHOR SCHEDULE			
SUBSTRATE	ANCHOR TYPE	MIN. EMBEDMENT (in.)	MIN. EDGE DISTANCE (in.)
WOOD SG = 0.55 MIN.	1/2" ASTM F593 BOLT	3.00	0.75
	3/8" LAG SCREW	3.00	0.75
	1/2" LAG SCREW	3.00	0.75
CONCRETE f'c = 3000 PSI MIN.	3/8" DEWALT SCREW-BOLT+	4.50	2.50
	1/2" DEWALT SCREW-BOLT+	4.50	2.50
	3/8" ITW REDHEAD DYNABOLT	1.50	2.50
	1/2" ITW REDHEAD DYNABOLT	1.875	2.50
	3/8" HILTI HIT-Z ROD W/ HIT-HY 200	4.50	2.375
	1/2" HILTI HIT-Z ROD W/ HIT-HY 200	4.50	2.625
STEEL 1/4" THK. MIN.	3/8" HWH SELF-TAPPING SCREW	THREE THREADS MIN. PENETRATION PAST STRUCTURE	0.50
	1/2" HWH SELF-TAPPING SCREW	THREE THREADS MIN. PENETRATION PAST STRUCTURE	0.50

ANCHOR ALLOWABLE WIND LOAD CAPCITY (PSF)								
SUBSTRATE	ANCHOR TYPE	ON CENTER SPACING (in.)	RAILING HEIGHT (In.)					
			36	39.75	42	48	60	72
WOOD SG = 0.55 MIN.	1/2" ASTM F593 BOLT	9.84	97.81	80.23	71.86	55.02	35.21	24.45
	3/8" LAG SCREW	9.84	21.81	17.89	16.02	12.27	7.85	5.45
	1/2" LAG SCREW	9.84	27.09	22.22	19.90	15.24	9.75	6.77
CONCRETE f'c = 3000 PSI MIN.	3/8" DEWALT SCREW-BOLT+	9.84	44.75	36.71	32.88	25.17	16.11	11.19
	1/2" DEWALT SCREW-BOLT+	9.84	55.69	45.67	40.91	31.32	20.05	13.92
	3/8" ITW REDHEAD DYNABOLT	9.84	14.17	11.62	10.41	7.97	5.10	3.54
	1/2" ITW REDHEAD DYNABOLT	9.84	20.11	16.50	14.78	11.31	7.24	5.03
	3/8" HILTI HIT-Z ROD W/ HIT-HY 200	9.84	23.63	19.38	17.36	13.29	8.51	5.91
	1/2" HILTI HIT-Z ROD W/ HIT-HY 200	9.84	30.48	25.00	22.39	17.14	10.97	7.62
STEEL 1/4" THK. MIN.	3/8" HWH SELF-TAPPING SCREW	9.84	28.16	23.10	20.69	15.84	10.14	7.04
	1/2" HWH SELF-TAPPING SCREW	9.84	37.53	30.79	27.58	21.11	13.51	9.38

FUTUREGLASS

GLASSWAREHOUSE

FUTUREGLASS
GLASS WAREHOUSE
1319 ROCKY POINT DRIVE, SUITE 200
OCEANSIDE, CA 92056
PH: (760) 536-3640

TITLE: RAMA - MODEL RAN-CHRES
GLASS BASESHOE RAILING

ANCHOR SCHEDULE &
ANCHOR CAPACITY TABLES

PREPARED BY: BUILDING DROPS, INC.

1900 NE MIAMI COURT, STE. 2-15
MIAMI, FL 33132
PH: (954)399-8478
FAX: (954)744-4738
WEB: www.buildingdrops.com



REMARKS	BY	DATE

THE INSTALLATION DETAILS DESCRIBED HEREIN ARE GENERIC AND MAY NOT REFLECT ACTUAL CONDITIONS FOR A SPECIFIC SITE. IF SITE CONDITIONS CAUSE INSTALLATION TO DEVIATE FROM THE REQUIREMENTS DETAILED HEREIN, A LICENSED ENGINEER OR ARCHITECT SHALL PREPARE SITE SPECIFIC DOCUMENTS FOR USE WITH THIS DOCUMENT.

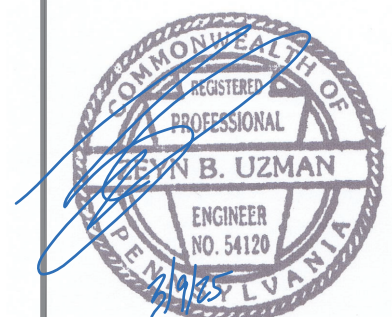

BUILDING DROPS, INC.
1900 NE MIAMI COURT, STE. 2-15
MIAMI, FL 33132
FBPE CERT. OF AUTHORIZATION No. 29578

DATE: **10.30.24**

DWG. BY: **DI** CHK. BY: **HFN**

SCALE: **NTS**

DWG. #: **GLW002**

SHEET:

6

OF 9

c:\users\y\anivara\building_drops, inc\building_drops, inc\projects\glass_warehouse, llc\ev-24-0946.1 - engineering evaluation - base shoe system and posted glass railing\dwgs\base shoe\other states\glw002 - ibc.dwg 1/30/2025 11:20 AM

HANDRAIL TYPES AND MAX. ALLOWABLE SPANS



- AGE-SHR42 HANDRAIL:**
- SIMPLY SUPPORTED: 10.92 FT
 - CANTILEVER: 3.0 FT

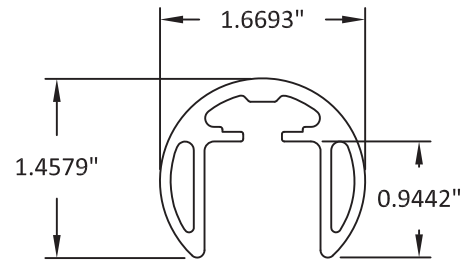

- DRA-AHR42 HANDRAIL:**
- SIMPLY SUPPORTED: 10.75 FT
 - CANTILEVER: 2.75 FT

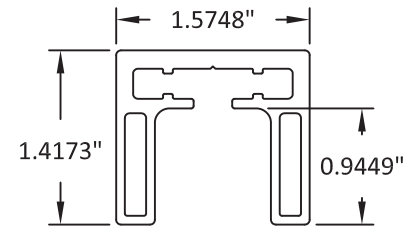

- COR-AHS HANDRAIL:**
- SIMPLY SUPPORTED: 11.42 FT
 - CANTILEVER: 3.08 FT

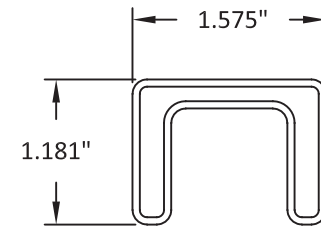

- MAT-SHS HANDRAIL:**
- SIMPLY SUPPORTED: 10.58 FT
 - CANTILEVER: 2.75 FT

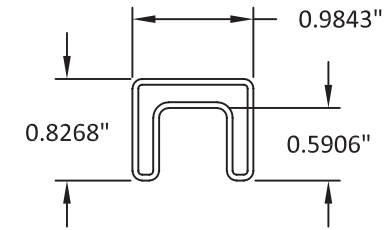

- HG25S XS HANDRAIL:**
- SIMPLY SUPPORTED: 3.08 FT
 - CANTILEVER: 0.58 FT

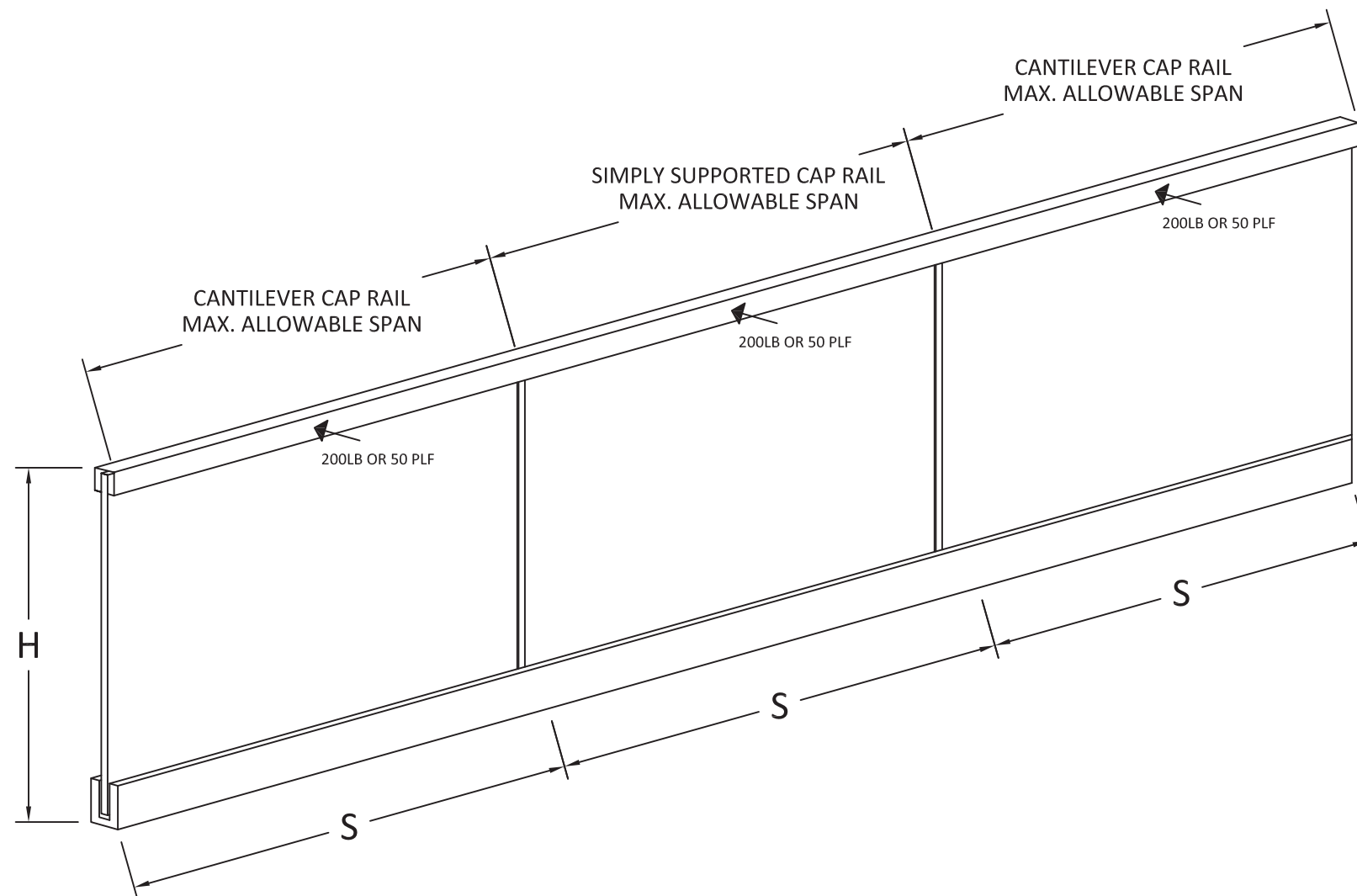

NOTE:
CANTILEVER SPAN ONLY APPLIES WHEN TOP RAIL IS NOT FIXED TO A STRUCTURE.
IF CAP RAIL IS FIXED TO A STRUCTURE, USE SIMPLY SUPPORTED MAX ALLOWABLE SPAN.

FUTUREGLASS

GLASSWAREHOUSE

FUTUREGLASS
GLASS WAREHOUSE
1319 ROCKY POINT DRIVE, SUITE 200
OCEANSIDE, CA 92056
PH: (760) 536-3640

TITLE: RAMA - MODEL RAN-CHRES
GLASS BASESHOE RAILING

HANDRAIL TYPES &
ALLOWABLE SPANS

PREPARED BY: **BUILDING DROPS, INC.**

1900 NE MIAMI COURT, STE. 2-15
MIAMI, FL 33132
PH: (954)399-8478
FAX: (954)744-4738
WEB: www.buildingdrops.com



REMARKS	BY	DATE

THE INSTALLATION DETAILS DESCRIBED HEREIN ARE GENERIC AND MAY NOT REFLECT ACTUAL CONDITIONS FOR A SPECIFIC SITE. IF SITE CONDITIONS CAUSE INSTALLATION TO DEVIATE FROM THE REQUIREMENTS DETAILED HEREIN, A LICENSED ENGINEER OR ARCHITECT SHALL PREPARE SITE SPECIFIC DOCUMENTS FOR USE WITH THIS DOCUMENT.

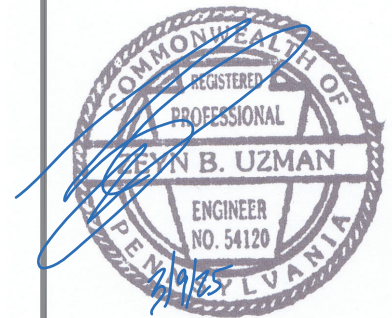

BUILDING DROPS, INC.
1900 NE MIAMI COURT, STE. 2-15
MIAMI, FL 33132
FBPE CERT. OF AUTHORIZATION No. 29578

DATE: **10.30.24**

DWG. BY: **DI** CHK. BY: **HFN**

SCALE: **NTS**

DWG. #: **GLW002**

SHEET:

7

OF 9

TYP. ALLOWABLE WIND LOADS

ALLOWABLE WIND LOADS (PSF)						
WIND SPEED (MPH)	W _{ASD} FOR Cf = 1.3			W _{ASD} FOR Cf = 2.6		
	EXP. B K _Z = 0.7	EXP. C K _Z = 0.85	EXP. D K _Z = 1.03	EXP. B K _Z = 0.7	EXP. C K _Z = 0.85	EXP. D K _Z = 1.03
100	9.50	11.53	13.98	19.00	23.07	27.95
110	11.49	13.95	16.91	22.98	27.91	33.82
120	13.68	16.61	20.12	27.35	33.21	40.25
130	16.05	19.49	23.62	32.10	39.98	47.24
140	18.62	22.60	27.39	37.23	45.21	54.78
150	21.37	25.95	31.44	42.74	51.90	62.89
160	24.31	29.52	35.78	48.63	59.05	71.55
170	27.45	33.33	40.39	54.90	66.66	80.78
180	30.77	37.37	45.28	61.54	74.73	90.56

PREMISES FOR WIND LOADS:

1. WIND LOADS ARE BASED ON ASCE 7.
2. THE FOLLOWING ASSUMPTIONS HAVE BEEN MADE:
 - a. K_d = 0.85
 - b. K_zt = 1.0
 - c. MAX. HEIGHT, Z = 15 FT
3. C_f VALUES SHOWN ON TABLE ARE TWO OF THE TYPICAL EXTREME VALUES. FOR OTHER C_f VALUES MULTIPLY THE WIND LOAD BY C_f/1.3 OR REFER TO ASCE 7 FOR MORE DETAILS.
4. FOR HEIGHTS ABOVE 15 FT REFER TO ASCE 7 FOR ADDITIONAL FACTORS.
5. WIND LOADS DISPLAYED ARE GENERIC AND MAY NOT REFLECT THE JOBSITE CONDITIONS. IF SITE SPECIFIC WIND LOADS ARE REQUIRED A LICENSED ENGINEER SHALL PREPARE SITE SPECIFIC WIND LOADS FOR USE WITH THIS PRODUCT.
6. REFER TO SHEET 9 FOR A RISK CATEGORY II WIND SPEED MAP PER ASCE 7.

FUTUREGLASS

GLASSWAREHOUSE

FUTUREGLASS
GLASS WAREHOUSE
1319 ROCKY POINT DRIVE, SUITE 200
OCEANSIDE, CA 92056
PH: (760) 536-3640

TITLE: RAMA - MODEL RAN-CHRES
GLASS BASESHOE RAILING

ALLOWABLE WIND LOADS
PER ASCE 7

PREPARED BY:
BUILDING DROPS, INC.

1900 NE MIAMI COURT, STE. 2-15
MIAMI, FL 33132
PH: (954)399-8478
FAX: (954)744-4738
WEB: www.buildingdrops.com



REMARKS	BY	DATE

THE INSTALLATION DETAILS DESCRIBED HEREIN ARE GENERIC AND MAY NOT REFLECT ACTUAL CONDITIONS FOR A SPECIFIC SITE. IF SITE CONDITIONS CAUSE INSTALLATION TO DEVIATE FROM THE REQUIREMENTS DETAILED HEREIN, A LICENSED ENGINEER OR ARCHITECT SHALL PREPARE SITE SPECIFIC DOCUMENTS FOR USE WITH THIS DOCUMENT.

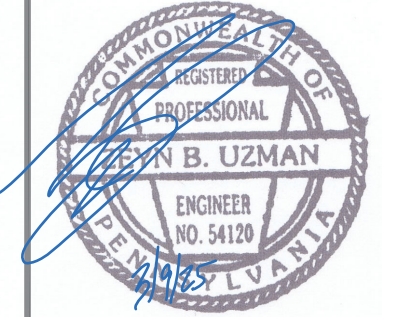

BUILDING DROPS, INC
1900 NE MIAMI COURT, STE. 2-15
MIAMI, FL 33132
FBPE CERT. OF AUTHORIZATION No. 29578

DATE:	10.30.24	
DWG. BY:	DI	CHK. BY: HFN
SCALE:	NTS	
DWG. #:	GLW002	

SHEET:
8
OF 9

WIND SPEED MAP

mph (m/sec.)



FUTUREGLASS

GLASSWAREHOUSE

FUTUREGLASS
GLASS WAREHOUSE
1319 ROCKY POINT DRIVE, SUITE 200
OCEANSIDE, CA 92056
PH: (760) 536-3640

TITLE: RAMA - MODEL RAN-CHRES
GLASS BASESHOE RAILING

WIND SPEED MAP

PREPARED BY:
BUILDING DROPS, INC.

1900 NE MIAMI COURT, STE. 2-15
MIAMI, FL 33132
PH: (954)399-8478
FAX: (954)744.4738
WEB: www.buildingdrops.com



REMARKS	BY	DATE

THE INSTALLATION DETAILS DESCRIBED HEREIN ARE GENERIC AND MAY NOT REFLECT ACTUAL CONDITIONS FOR A SPECIFIC SITE. IF SITE CONDITIONS CAUSE INSTALLATION TO DEVIATE FROM THE REQUIREMENTS DETAILED HEREIN, A LICENSED ENGINEER OR ARCHITECT SHALL PREPARE SITE SPECIFIC DOCUMENTS FOR USE WITH THIS DOCUMENT.

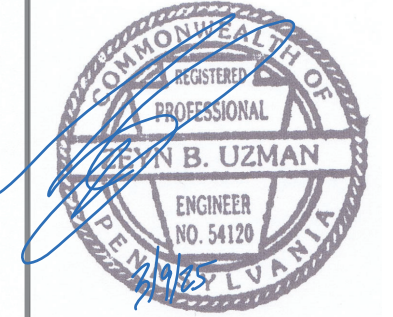

BUILDING DROPS, INC.
1900 NE MIAMI COURT, STE. 2-15
MIAMI, FL 33132
FBPE CERT. OF AUTHORIZATION No. 29578

DATE:	10.30.24	
DWG. BY:	DI	CHK. BY: HFN
SCALE:	NTS	
DWG. #:	GLW002	

SHEET:
9
OF 9