

Installation Instructions

Heated Airbath with Heated Surface

Record your model number:
Noter le numéro de modèle:
Anoté su número de modelo: _____

Français, page 11
Español, página 21

KOHLER®

Thank You for Choosing KOHLER

Need help? Contact our Customer Care Center.

- USA/Canada: 1-800-4KOHLER (1-800-456-4537) Mexico: 001-800-456-4537
- Service parts: kohler.com/serviceparts
- Care and cleaning: kohler.com/clean
- Patents: kohlercompany.com/patents

Installation Instructions

 **WARNING:** When using electrical products, basic precautions should always be followed, including the following:

 **DANGER:** Risk of electric shock. Connect only to a circuit protected by a Ground-Fault Circuit-Interrupter (GFCI)*.

Building materials and wiring should be routed away from the blower body and other heat-producing components of the unit.

Install to permit access for servicing.

A pressure wire connector marked "Earth/Ground" is provided within the wiring compartment. To reduce the risk of electric shock, connect this connector to the grounding terminal of your electric service or supply panel with copper wire equivalent in size to the circuit conductor supplying this equipment.

A pressure wire connector is provided on the exterior of the pump or control within this unit to permit connection of a bonding conductor between this unit and all the other exposed metal in the vicinity, as needed to comply with local requirements.

NOTICE: Grounding is required. The unit should be installed and grounded by a qualified service representative.

 **WARNING: Risk of injury or property damage.** Read all instructions thoroughly before beginning installation.

 **WARNING: Risk of electric shock.** A qualified electrician should make all electrical connections.

 **WARNING: Risk of electric shock.** Disconnect the power before installation or servicing.

NOTICE: Follow all plumbing, building, and electrical codes. In Canada, install this unit in accordance with the Canadian Electrical Code, Part 1.

*Outside North America, this may be known as a Residual Current Device (RCD).

Product Information

Electrical Requirements

⚠ WARNING: Risk of burns, fire, electric shock, or injury. Do not operate the heated surface if the junction box power supply cord is damaged. For proper guidance to have this product repaired, please call: 1-800-4KOHLER from within the USA or Canada, or 001-800-456-4537 from within Mexico.

The installation must have **two** Class A Ground-Fault Circuit-Interrupters (GFCI). The GFCI protects against line-to-ground shock hazard. **Use a 120 V, 15 A, 60 Hz dedicated service for the blower. Use a separate 120 V, 15 A, 60 Hz dedicated service for the bubble heater.**

If the blower supply cord is damaged, it must be replaced by the manufacturer, its service agent, or similarly qualified persons in order to avoid a hazard.

Product Notices

IMPORTANT! The recommended operating pressure for this system is 35-60 psi (241-414 kPa).

NOTICE: Keep the area around the blower clean and free of debris. Verify that the area around the blower is free of sawdust, insulation, dirt, and other small loose debris. Such material can block the blower air ducts and reduce the air flow through the blower.

NOTICE: This product contains an automatic water purge mode that turns the blower on for 5 minutes after the unit is turned off and drained.

Tools and Materials

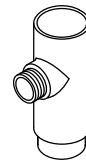
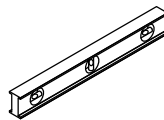
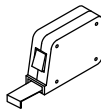
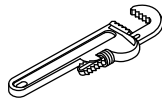
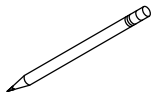
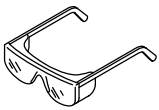

1/2 NPT Brass

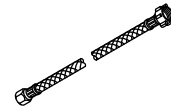

1/2"

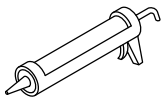

100% Silicone Sealant

Plus:

** Do not use gypsum cement.*

- Conventional Woodworking Tools and Materials
- Drop Cloth
- Construction Adhesive (Optional)
- Cement* or Mortar (Optional)
- 2x4s
- Plastic Film (Optional)
- 1/8" (3 mm) Spacers

Before You Begin

NOTICE: Measure your product for site preparation. Note the model number located on the bath blower, then visit the product page at us.kohler.com for more information.

NOTICE: Remote blower installation kit K-1446 is available for relocating the blower.

NOTICE: Provide generous, unrestricted access to the blower. You must provide access for servicing the blower. The access must be located immediately next to the blower.

NOTICE: Do not lift the bath by the piping or blower, or use the piping or blower for structural support of the bath. To avoid damage to the bath, lift at the sides of the bath.

NOTICE: Do not support the weight of the bath by the rim. Plan to shim under the bath as needed when leveling the bath.

NOTICE: Drop-in models are not intended for alcove installation. Use a flanged model for alcove installations.

NOTICE: Drop-in, alcove, or corner installation is possible, depending on the product chosen.

NOTICE: Verify that the flooring offers adequate support for your bath, and verify that the subfloor is flat and level.

NOTICE: This product requires remote blower installation. **Refer to the instructions included with the remote blower kit before proceeding.**

NOTICE: Provide adequate ventilation and a minimum 15 cubic feet (.4 cubic meters) of air space in the installed location for cooling the motor and to supply sufficient air for the blower. Do not install the blower motor closer than 1" (25 mm) from the wall or other objects.

Carefully unpack and inspect the new bath for damage before installation. If there is damage do not install the bath; contact your dealer.

1. Prepare the Site

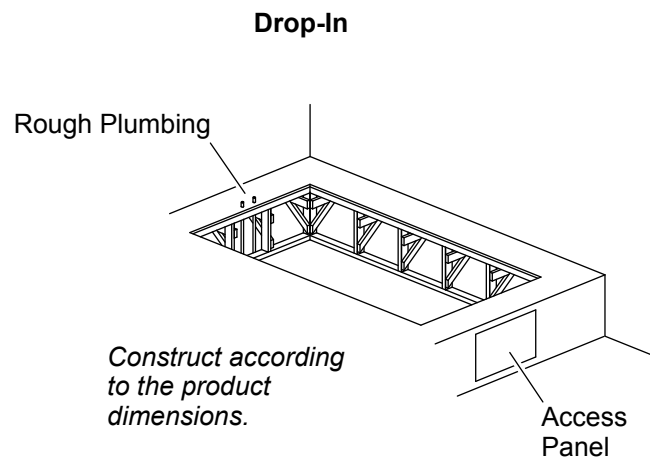
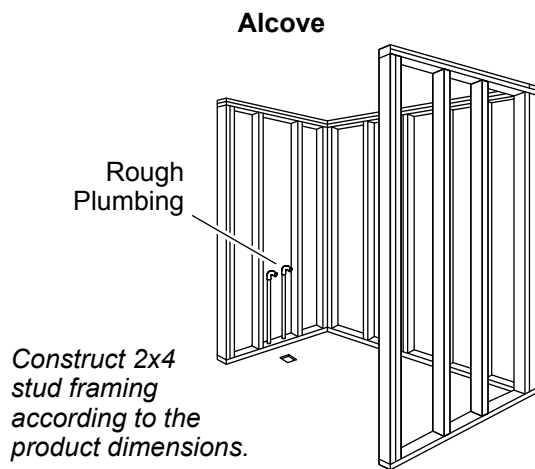

- Construct 2x4 stud framing according to the product dimensions.
- Install an access panel for future blower servicing. The access panel must be at least 30" (762 mm) wide by 15" (381 mm) high. Integrated apron models have access panels included in the apron designs.
- Install the rough plumbing.
- Install the drain to the bath according to the drain manufacturer's instructions.
- Protect the bath surface by positioning a clean drop cloth in the bowl bottom.

2. Install the Bath

Option 1

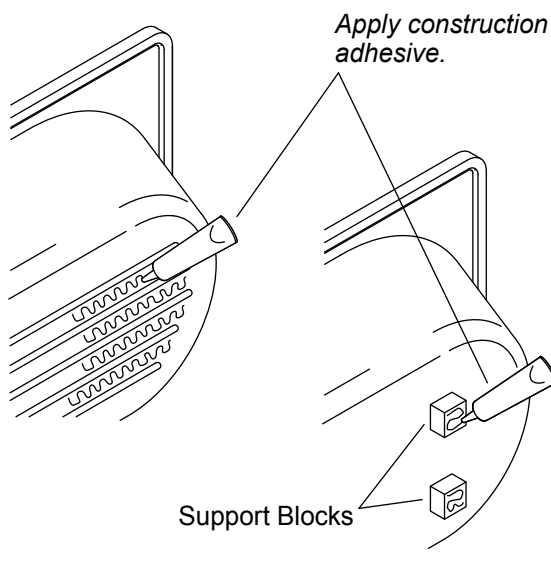

Option 2

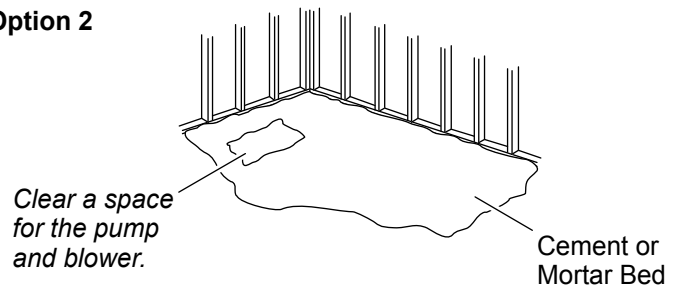

Alcove Installations

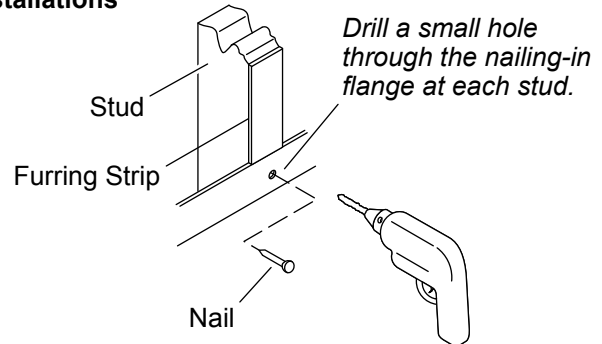

IMPORTANT! Use maximum 1/8" (3 mm) thick spacers under the bath rim to verify that the rim does not contact the deck.

NOTICE: Do not lift the bath by the piping or blower, or use the piping or blower for structural support of the bath. To avoid damage to the bath, lift by the rim at the sides of the bath.

- If the subfloor is not level, shim under the bath as needed.

Option 1: Install Using Construction Adhesive

NOTE: Some models come with support blocks; some models have molded supports.

- Apply a generous amount of high-quality construction adhesive to the bottom of the support blocks or molded supports. With help, carefully lift the bath into position.
- Apply weight to the bath bowl until the adhesive sets.

Option 2: Using a Cement or Mortar Bed

NOTE: Do not use gypsum cement or drywall compound for this application, as they will not provide an acceptable, durable bond.

NOTE: Lay plastic film on wooden subfloors if desired to prevent water absorption.

NOTE: The blower must rest directly on the subfloor. The blower should not be in contact with mortar.

- Set the bowl area in 1" (25 mm) to 2" (51 mm) of mortar cement.
- Apply weight to the bath bowl until the mortar sets.

Secure the Nailing-In Flanges (Alcove Units)

- Drill a small pilot hole through the nailing-in flange at each stud. Add shims as needed.
- Use large-head galvanized nails to secure the nailing-in flange to the studs.

- Nail furring strips to the studs.

Install the Plumbing

- Insert the drain tailpiece into the trapway. Secure the drain tailpiece to the trapway.
- Install the faucet valve.
- Check the drain connections for leakage.

3. Make the Electrical Connections

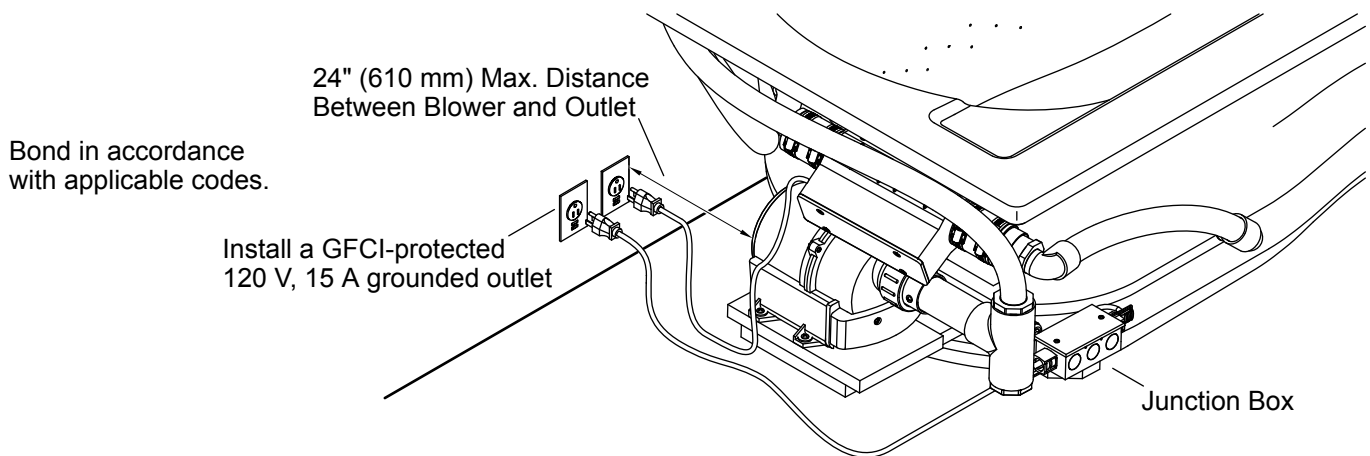

⚠ DANGER: Risk of electric shock. Connect the junction box, blower motor, and bubble heater to properly grounded, grounding-type receptacles protected by a Ground-Fault Circuit-Interrupter (GFCI)*. Do not remove the grounding pins from the plugs. Do not use grounding adapters.

⚠ WARNING: Risk of electric shock. Verify that the power has been disconnected before performing the following procedures.

NOTICE: The blower/junction box and bubble heater are equipped with cords and plugs. A qualified electrician must install two GFCI*-protected, 120 V, 15 A, grounded electrical outlets. The blower/junction box must be on its own dedicated circuit (circuit #1). The bubble heater must be on its own dedicated circuit (circuit #2). No other loads should be on these circuits.

Install two GFCI*-protected electrical outlets within reach of the 24" (610 mm) power cords.

Plug the blower/junction box cord into the outlet in circuit #1.

*Outside North America, this device may be known as a Residual Current Device (RCD).

4. Connect the Bubble Heater

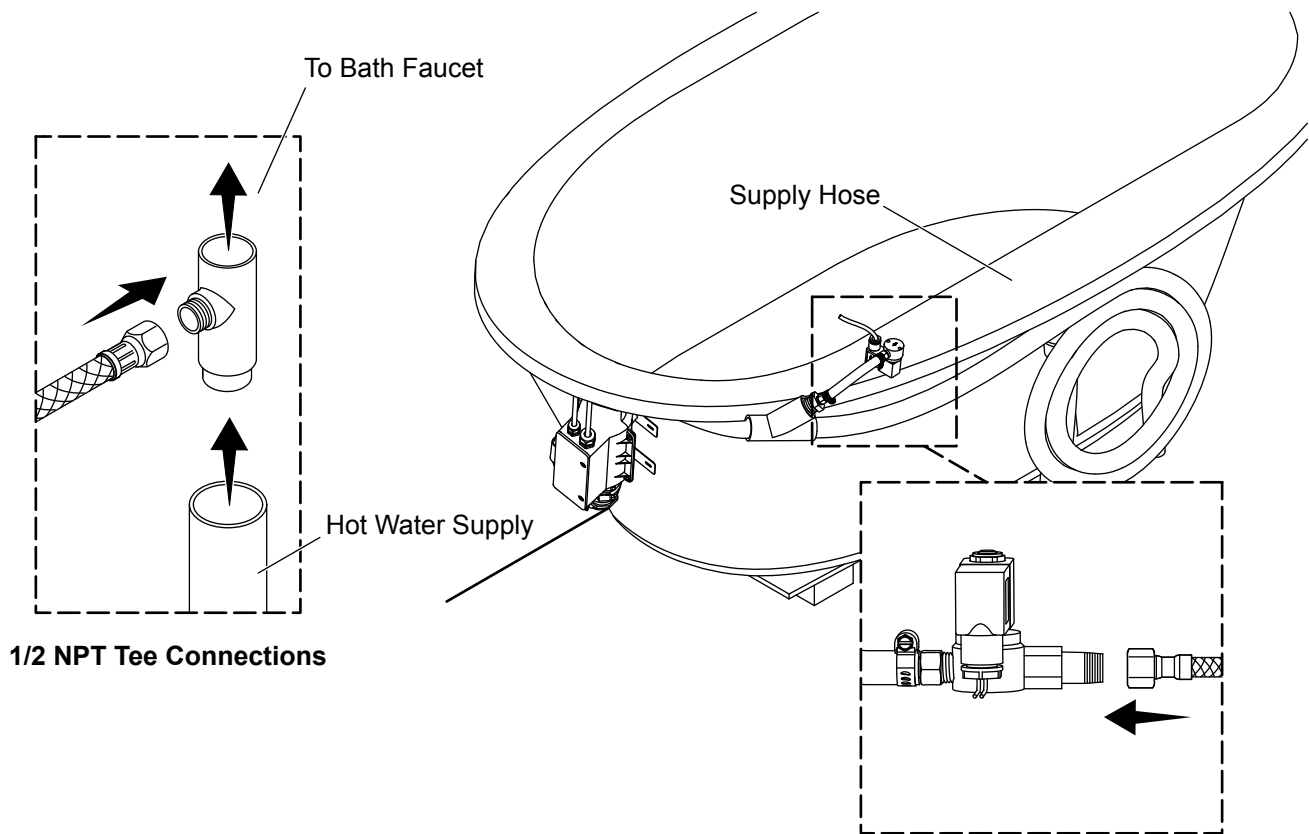

NOTE: The water supply setup may differ depending on the type bath or bath faucet that is installed.

- Install the tee (not supplied) to the hot water valve on the bath faucet.
- Thread the supply hose (not supplied) onto the 1/2" NPT port of the tee.
- Thread the opposite side of the supply hose into the 1/2" NPT brass nipple. **Do not kink the hoses.**
- Plug the bubble heater cord into the remaining GFCI*-protected outlet.

*Outside North America, this device may be known as a Residual Current Device (RCD).

5. Complete the Installation

Test Run the Bath

- Operate the heated surface user keypad to test the temperature settings.
- Fill the bath to a level at least 4" (102 mm) above the top of the highest airjet.
- Operate the bath for 5 minutes and check all bath piping connections for leaks. Check for leakage along the front, sides, and back of the bath.
- For additional information on bath operation, see the Homeowners Guide for this product.

Finish the Installation

IMPORTANT! Kohler Co. strongly recommends the use of 100% silicone sealant as instructed. Other sealants with high filler contents should be avoided, as they may shrink, separate, and peel over time.

- Install water-resistant wallboard and all finished wall, deck, and floor materials.
- Apply a minimum 1/8" (3 mm) bead of 100% silicone sealant to seal all areas where the bath and finished wall or deck meet.
- Install the faucet trim.

Clean-up After Installation

- When cleaning up after installation, **do not use abrasive cleansers**, as they may scratch and dull the bath surface. Use warm water and a liquid detergent to clean the surface of the bath.
- Remove stubborn stains or paint with turpentine or paint thinner. **Do not allow cleaners containing petroleum distillates to remain in contact with any bath surface for long periods of time.** Remove plaster by carefully scraping with a wood edge. Do not use metal scrapers, wire brushes, or other metal tools. Use a powder-type detergent on a damp cloth to provide mild abrasive action to any residual plaster.

Homeowners Guide

Heated Airbath with Heated Surface

Record your model number:
Noter le numéro de modèle:
Anoté su número de modelo: _____

Français, page 10
Español, página 18

KOHLER®

Thank You for Choosing KOHLER

Need help? Contact our Customer Care Center.

- USA/Canada: 1-800-4KOHLER (1-800-456-4537) Mexico: 001-800-456-4537
- Service parts: kohler.com/serviceparts
- Care and cleaning: kohler.com/clean
- Patents: kohlercompany.com/patents









Warranty

This product is covered under the KOHLER® Hydrotherapy Components Five-Year Limited Warranty, found at kohler.com/warranty. For a hardcopy of warranty terms, contact the Customer Care Center.

IMPORTANT SAFETY INSTRUCTIONS

READ AND FOLLOW ALL INSTRUCTIONS

INSTRUCTIONS PERTAINING TO A RISK OF FIRE, ELECTRIC SHOCK, OR INJURY TO PERSONS

-  **WARNING: When using electrical products, basic precautions should always be followed, including the following:**
-  **DANGER: Risk of accidental injury or drowning.** To reduce the risk of injury, do not permit children to use this bath unless they are closely supervised at all times.
-  **WARNING: Risk of personal injury.** To avoid injury, exercise care when entering or exiting the bath.
-  **WARNING: Risk of electric shock.** Do not permit electric appliances (such as a hair dryer, lamp, telephone, radio, or television) within 5' (1.5 m) of this bath.
-  **WARNING: The use of alcohol, drugs, or medication can greatly increase the risk of fatal hyperthermia.** Prolonged immersion in hot water may induce hyperthermia. Hyperthermia occurs when the internal temperature of the body reaches a level several degrees above the normal body temperature of 98.6°F (37°C). The symptoms of hyperthermia include an increase in the internal temperature of the body, dizziness, lethargy, drowsiness, and fainting. The effects of hyperthermia include: (a) failure to perceive heat, (b) failure to recognize the need to exit the bath, (c) unawareness of impending hazard, (d) fetal damage in pregnant women, (e) physical inability to exit the bath, and (f) unconsciousness resulting in the danger of drowning.
-  **WARNING: Risk of fetal injury.** Pregnant or possibly pregnant women should consult a physician before using the bath.
-  **WARNING: Risk of hyperthermia or drowning.** Do not use the bath immediately following strenuous exercise.
-  **WARNING: Risk of hyperthermia or drowning.** Water temperature in excess of 100°F (38°C) may cause injury. Test and adjust the water temperature before use.
-  **WARNING: Risk of personal injury.** Never drop or insert any object into any opening.

Use this bath only for its intended purpose as described in this guide. Do not use attachments not recommended by Kohler Co.

The bath must be connected only to a supply circuit that is protected by a Ground-Fault Circuit-Interrupter (GFCI)*. Such a GFCI should be provided by the installer and should be tested on a routine basis. To test the GFCI, press the test button. The GFCI should interrupt power. Press the reset button. Power should be restored. If the GFCI fails to operate in this manner, the GFCI is defective. If the GFCI interrupts power to the bath without the test button being pressed, a ground current is flowing, indicating the possibility of an electric shock. Do not use this bath. Disconnect the bath and have the problem corrected by a qualified service representative before using.

Repeated use of personal care products containing oils can damage plastic whirlpool components. Avoid using bath oils.

Whirlpool hydromassage action can cause even a small amount of bubble bath, bath soap, shampoo, or bath oil to foam excessively. For this reason, please do not use these products during whirlpool operation.

*Outside North America, this device may be known as a Residual Current Device (RCD).

SAVE THESE INSTRUCTIONS

Operating the Air System

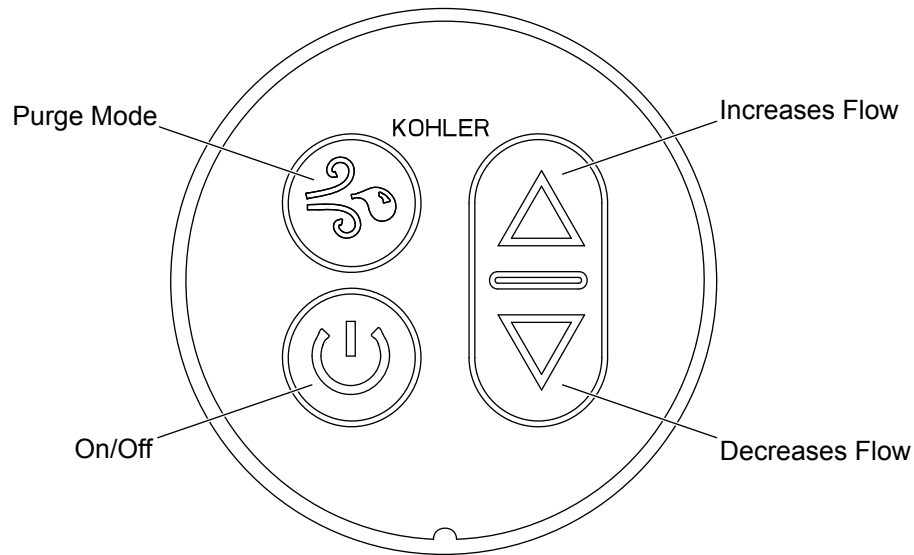

IMPORTANT! This product contains an automatic water purge mode that turns the blower on for 5 minutes after the unit is turned off and drained.

NOTE: The water temperature in the bath should never exceed 104°F (40°C).

- Close the drain, then fill the bath at least 4" (102 mm) above the top of the highest airjet.
- In order for the speed feature to function as intended, the water level must be at the overflow when user is in the bath.
- Use your hand to test the water temperature for comfort and safety, then carefully enter the bath.
- Press the [On/Off] icon to turn the blower on at medium speed. The blower will automatically run for 60 minutes unless turned off manually.
- Press the [Up] or [Down] arrow icons to increase or decrease the air flow.
- Press the [On/Off] icon a second time to turn off the blower.
- Carefully exit and drain the bath.

NOTE: After the bath drains below the water level sensor, a 5 minute purge mode will automatically start. Press the purge mode icon to manually turn the purge mode On or Off.

NOTE: If the bath does not function properly, refer to the "Troubleshooting" section.

Operating the Heated Surface

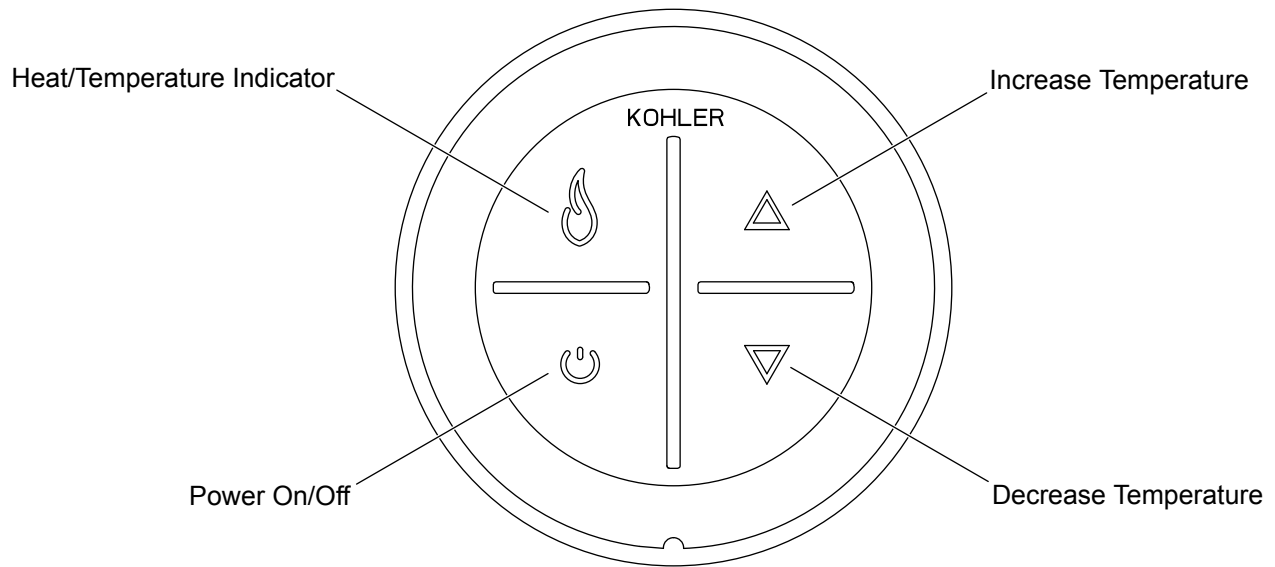

Keypad Operation

- Power Icon** - Turns the heater on and off.
- Heat/Temperature Indicator** - The [Flame] icon illuminates yellow, orange, or red depending on the heat level. Yellow indicates low heat, orange indicates medium heat, and red indicates high heat.
- Up Arrow** - Increases the temperature.
- Down Arrow** - Decreases the temperature.

NOTICE: The heater will remain on until it is manually turned off by pressing the [Power] icon.

NOTE: After 60 minutes of inactivity, the heater will automatically reset to low heat if the temperature was set to medium or high.

NOTE: The heater will turn on the last selected temperature setting.

NOTE: If the bath does not function properly, refer to the "Troubleshooting" section.

Confirm Heating System Operation

- Press the [Power] icon on the user keypad.
- Observe that the heat indicator turns yellow and the heater produces low heat.
- Press the [Up] arrow. Verify that the heat indicator turns orange and the temperature increases.
- Press the [Up] arrow a second time. Verify that the heat indicator turns red and the temperature increases.
- Press the [Down] arrow. Verify that the heat indicator turns orange and the temperature decreases.
- Press the [Down] arrow a second time. Verify that the heat indicator turns yellow and the temperature decreases.
- Press the [Power] icon to turn the heater off.

Care and Cleaning

- **Do not use powdered cleaners unless the cleaner is fully dissolved in water.** Solid substances could block the airjets.
- **Do not use full strength bleach or ammonia cleaning solutions.** Chemically active cleaning solutions can damage the bath surface.
- **Do not use abrasive cleansers or solvents on acrylic surfaces.** Abrasive cleaners and solvents can damage the bath surface.
- Wipe out your acrylic bath with a soft cloth after each use.
- Avoid detergents, disinfectants, or cleaning products in aerosol cans.

NOTE: To restore dull or scratched units: Apply white automotive polishing compound with a clean rag. Rub scratches and dull areas vigorously. Wipe off residue. Follow with a coat of white automotive paste wax. Do not wax areas where you walk or stand.

Cleaning Your User Keypad

Use a soft cloth to wipe the keypad after each use. If the surface becomes dirty, use a non-abrasive soap and warm water to clean.

Maintaining the Airjets

- If cleaning the airjets is necessary due to hard water deposits, use a small between-the-teeth dental brush and white vinegar. Dip the brush in the vinegar, brush the hole, rinse the brush in clean water, and then use the wet rinsed brush to rinse the hole.
- Fill the bath with water to the top row of airjets. Drain the bath and press the purge button.

For detailed cleaning information and products to consider, visit kohler.com/clean. To order Care & Cleaning information, call 1-800-456-4537.

Troubleshooting

This troubleshooting guide is for general aid only. A Kohler Co. Authorized Service Representative (ASR) or qualified electrician should correct any electrical problems. For warranty service, call 1-800-4KOHLER from within the USA and Canada, or 001-800-456-4537 from within Mexico.

Airbath System

Symptoms	Probable Cause	Recommended Action
1. Blower turns on by itself after the bath has been drained.	A. Normal operation. Automatic purge mode is working as designed.	A. No action is required. Automatic purge mode runs for five minutes after the bath is drained.
2. Blower turns off by itself after running for 5 minutes.	A. The Purge Mode icon was pressed instead of the On/Off icon.	A. Press the On/Off icon on the keypad. See the air bath operating instructions section.

Symptoms	Probable Cause	Recommended Action
3. Blower motor will not start.	<p>A. Power cord from blower motor is loose, disconnected, or damaged.</p> <p>B. User keypad cable loose or damaged.</p> <p>C. User keypad does not work.</p> <p>D. Blower motor does not work.</p>	<p>A. Check wiring for proper connections.</p> <p>B. Check wire connections. If necessary, replace user keypad cable.</p> <p>C. Replace user keypad.</p> <p>D. Replace the blower motor.</p>
4. Blower motor stops running and will not immediately restart.	<p>A. Blower motor overheated and protection device activated.</p>	<p>A. Check for blockage at blower air intake. Remove blockage and allow motor to cool.</p>
5. Blower motor starts, some but not all airjets are working.	<p>A. Blower motor speed is too low.</p> <p>B. Blower motor inlet is blocked.</p> <p>C. Blower motor does not work.</p> <p>D. Blower motor discharge is blocked.</p> <p>E. Airjets are clogged.</p>	<p>A. Increase speed.</p> <p>B. Clean blower motor inlet.</p> <p>C. Replace the blower motor.</p> <p>D. Clear blockage.</p> <p>E. Use a small between-the-teeth dental brush and white vinegar. Dip the brush in the vinegar, brush the hole, rinse the brush in clean water, and then use the wet rinsed brush to rinse the hole.</p>
6. Blower motor runs but no air bubbles are observed.	<p>A. Blower motor inlet is blocked.</p> <p>B. Airjets are clogged.</p> <p>C. Blower motor does not work.</p>	<p>A. Clean blower motor inlet.</p> <p>B. Use a small between-the-teeth dental brush and white vinegar. Dip the brush in the vinegar, brush the hole, rinse the brush in clean water, and then use the wet rinsed brush to rinse the hole.</p> <p>C. Replace the blower motor.</p>
7. Blower motor operates, air bubbles are observed, but speed feature does not work.	<p>A. Water level is too low.</p> <p>B. Blower motor inlet is blocked.</p> <p>C. Loose, disconnected, or damaged wiring harness.</p> <p>D. User keypad does not work.</p> <p>E. Blower motor does not work.</p>	<p>A. Add water to the bath such that it is at the overflow when user is in bath.</p> <p>B. Clean blower motor inlet.</p> <p>C. Check wiring for proper connections. Replace the wiring harness if necessary.</p> <p>D. Replace the user keypad.</p> <p>E. Replace the blower motor.</p>
8. Blower motor does not turn off when the On/Off button is pressed.	<p>A. User keypad does not work.</p> <p>B. Loose, disconnected, or damaged wiring harness.</p> <p>C. Control does not work.</p>	<p>A. Replace the user keypad.</p> <p>B. Check wiring for proper connections. Replace the wiring harness if necessary.</p> <p>C. Replace the control.</p>
9. Blower motor runs but water is cooling off too quickly.	<p>A. There is no power to the heated conduit.</p> <p>B. There is a heated conduit fault.</p>	<p>A. Set/reset the GFCI supplying heated conduit; check wiring.</p> <p>B. Check for a blinking yellow light on the heated conduit. A yellow light indicates a system fault. Replace the heated conduit.</p>
10. Low heat fault. Light blinks yellow once then repeats pattern after one second pause.	<p>A. Water for solenoid valve connected to COLD supply.</p> <p>B. Water injection assembly not working.</p>	<p>A. Move water supply to hot water supply. Remove power to heated conduit for 10 seconds to reset.</p> <p>B. Replace water injection assembly.</p>

Symptoms	Probable Cause	Recommended Action
11. Thermistor fault. Light blinks yellow twice then repeats pattern after one second pause.	A. Faulty connection.	A. Check wiring for proper connections. Replace the heated conduit if necessary.
12. Communication fault. Light blinks yellow three times then repeats pattern after one second pause.	A. Heater controller communication error.	A. Remove power to the heated conduit for 10 seconds to reset. Re-apply power and wait 3 minutes. If light still blinks yellow 3 times, replace heated conduit assembly.
13. High heat fault. Light blinks yellow four times then repeats pattern after one second pause.	A. Water injection assembly not working. B. There is a heated conduit fault.	A. Verify that water is connected to HOT water supply. Remove power to heated conduit for 10 seconds to reset. B. Replace heated conduit.
14. Purge mode does not work.	A. User keypad does not work. B. Control does not work.	A. Replace the user keypad. B. Replace the control.
15. Bath does not purge automatically.	A. Blower does not work. B. Water level sensors faulty. C. Water level sensors run together.	A. Replace the blower. B. Replace the wires. C. Separate the wires so that they run along different sides of the bath.

Heated Surface

Symptoms	Probable Cause	Recommended Action
1. Heated bath does not turn on.	A. No power to power supply. B. User keypad cable loose or damaged. C. User keypad does not work. D. Power supply does not work.	A. Set/reset GFCI or RCD breaker; check wiring. B. Check wire connections. If necessary, replace user keypad cable. C. Check wire connections. Replace user keypad. D. Replace power supply.
2. Bath is turned on, but there is little or no heat.	A. Heater cable loose or damaged. B. Heater/insulation loose on the bath. C. Heat indicator is yellow or orange. D. Heater does not work. E. Temperature sensor does not work.	A. Check wire connections. If necessary, replace heater cable. B. Secure the heater/insulation to the bath. C. Press the [Up] arrow to increase temperature. D. Replace the heater. E. Replace the heater.
3. Temperature does not automatically reset to low after one hour.	A. Temperature sensor does not work.	A. Replace the heater and/or keypad.

Symptoms	Probable Cause	Recommended Action
4. Heat indicator is blinking red.	A. Heating system needs to be reset. B. Heater does not work.	A. Press the [Power] icon to turn the power OFF. Wait 10 seconds, then turn the power ON. B. Replace the heater.
5. Heat indicator is blinking yellow.	A. Heating system needs to be reset. B. Temperature sensor does not work.	A. Press the [Power] icon to turn the power OFF. Wait 10 seconds, then turn the power ON. B. Replace the heater.