

INSTRUCTION MANUAL

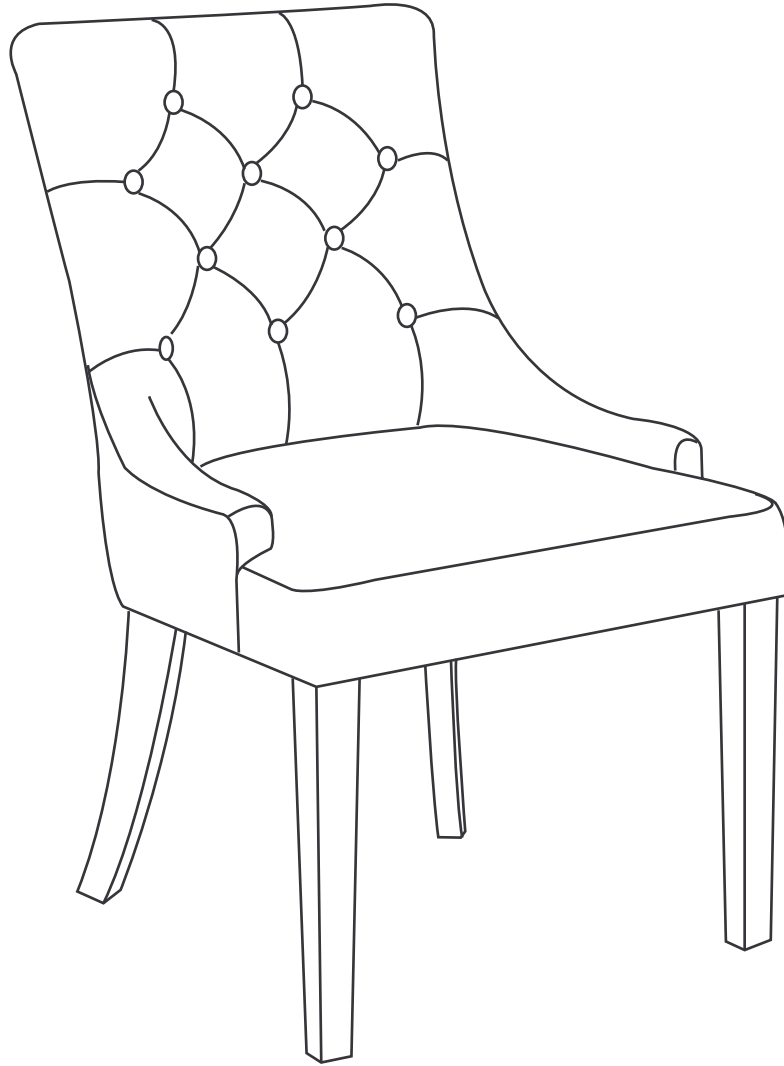

Linen Fabric Tufted Upholstered Dining Chair
SKU: ID301

! CARE & MAINTENANCE

- Be careful when assembly, avoid hurting the paint .
- Clean the dust with lukewarm water, mild detergent & soft cloth.
- Firmly secure all bolts before use, do not use any part of this item as a step ladder.
- Reconfirm that all bolts, screws, and nuts are secure every 90 days.
- Do not use or store this item in the proximity of open flame or flammable/combustible chemicals.

TOOLS REQUIRED



ALLEN WRENCH
(PROVIDED)



260 LBS
CAPACITY



1 PERSON
ASSEMBLY



UP TO 10 MIN.
ASSEMBLY

HARDWARE

1 Flat washer



$\Phi 8$
8PCS

2 Lock washer



$\Phi 8$
8PCS

3 Allen Key



M8
1PC

4 Shorter Screw



M8x55MM
4PCS

5 Longer Screws



M8x60MM
4PCS

PARTS

A

Back



1PC

B

Hind Legs



2PCS

C

Front Legs



With 2pcs
adjustable feet leveler

2PCS

PACKING

Open the zipper take out legs
and hardware

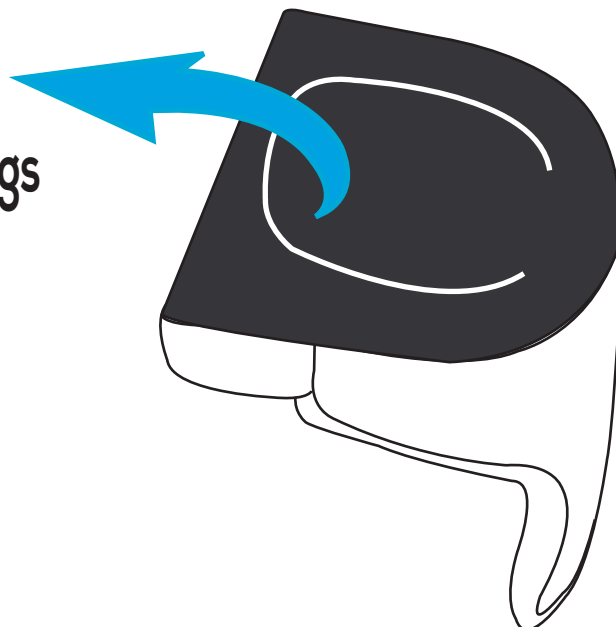

PRODUCT ASSEMBLY

1

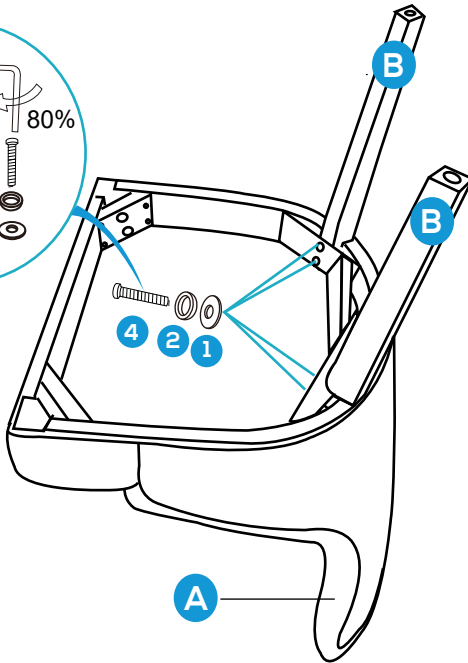
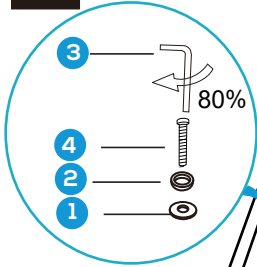

Put chair back on a clean flat surface.
Align Hind legs in the seat pad as shown in the diagram.

Using SHORTER SCREW (4) with Washer (#2, 1).

DO NOT FULLY TIGHTEN.

First **HAND** tighten then tightened using key up-to 60-80% only at this stage.

2

C Front legs

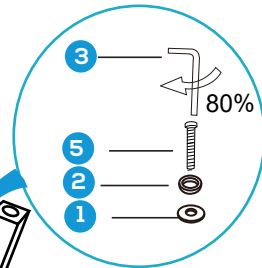
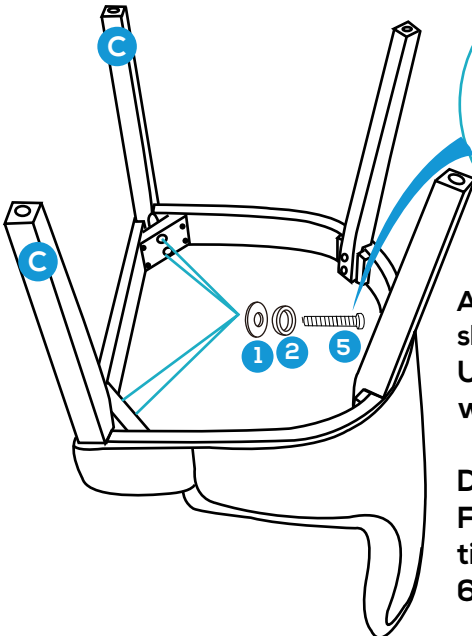
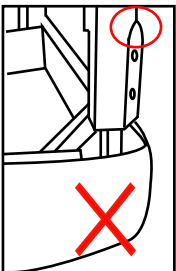
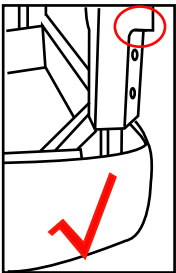

Align front legs in the seat pad as shown in the diagram.
Using LONGER SCREW (5) with Washer (#2, 1).

DO NOT FULLY TIGHTEN.
First **HAND** tighten then tightened using key up-to 60-80% only at this stage.

PRODUCT ASSEMBLY

3

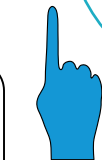
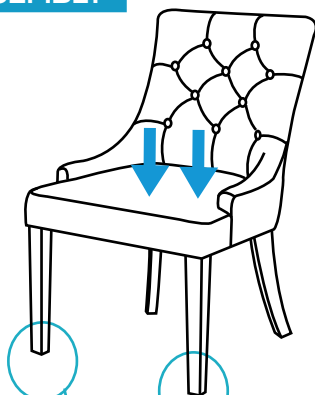
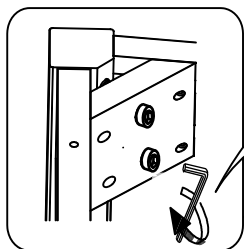
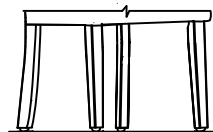
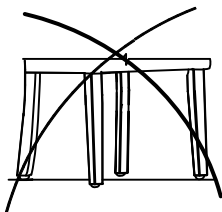

100%

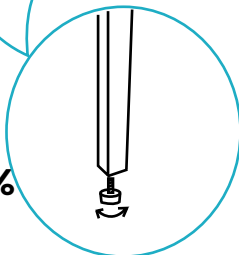

Adjustable feet leveler

Put chair in the upright position and **SIT ON THE CHAIR** to press downwards on the seat pad.

Ensuring that all 4 feet touch the ground and chair is leveled.

Proceed to tighten all screws making sure the chair remains level when tightening.

Check that all screws are tight on a regular basis to ensure chair remains level and secure.

Also you can using adjustable feet to keep four legs level.

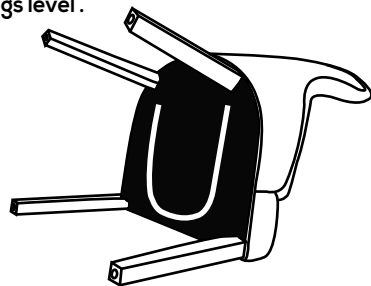

Then close the black fabric cover

4

