

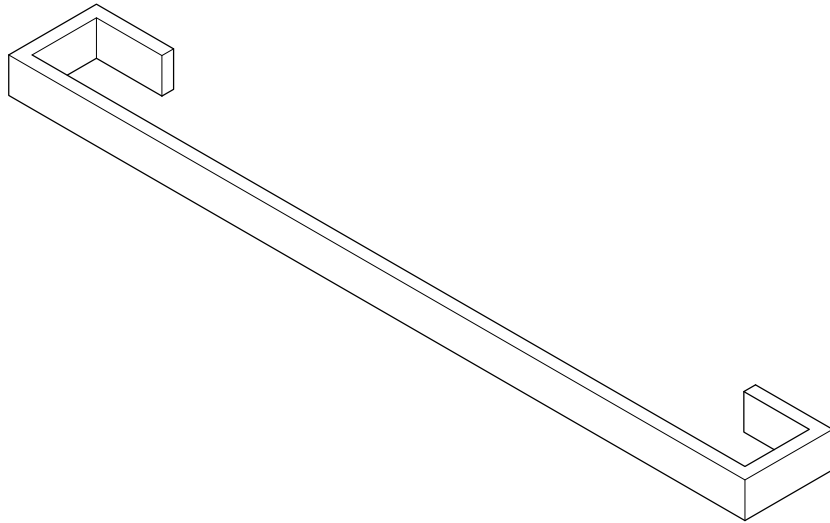

KINGSTON

KITCHEN & BATH

Towel Bar Installation

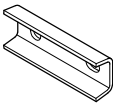
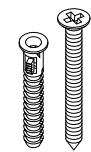

Parts:

Mounting Bracket	Mounting Screw & Anchor	Set Screw
		
2 Pcs	4 Pcs	4 Pcs

CAUTION

Failure to follow all installation directions may cause product to detach from the wall and cause serious injury

www.kingstonbrass.com
 TOLL-FREE CUSTOMER SERVICE: 1-877-2-KBRASS
 TECHNICAL SUPPORT E-mail: service@kingstonbrass.com
 12775 Reservoir Street, Chino, CA 91710

TOOLS REQUIRED

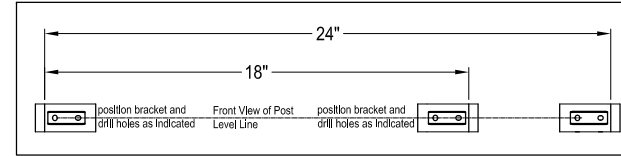
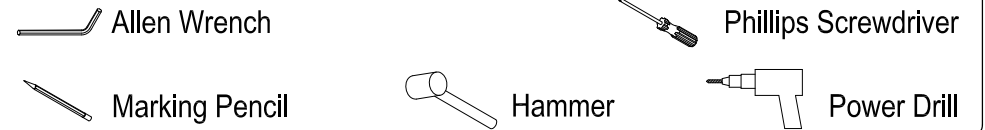

Fig. 1

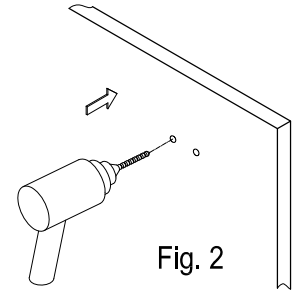

Fig. 2

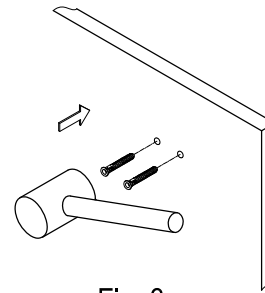

Fig. 3

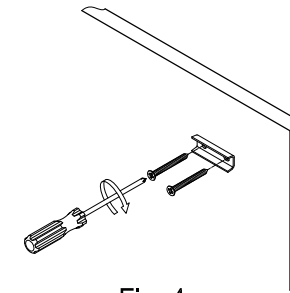

Fig. 4

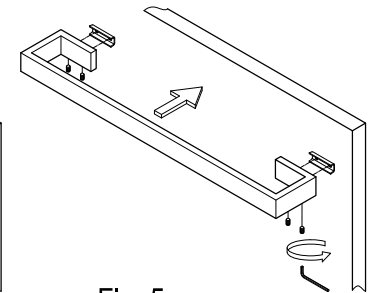

Fig. 5

Installation Steps:

- Step 1. Locate where you would like to install the towel bar by measuring from end to end on the towel bar then measure the desired height on the wall where the towel bar will hang (fig 1).
- Step 2. Position the mounting template on the desire location, and use a level to make sure it is level.
- Step 3. Use a pencil to mark both bracket holes. Repeat this step for the other side.
- Step 4. Remove the template from wall and use a 1/4" drill bit to pre-drill holes in the drywall where pencil marks are drawn (fig 2).
- Step 5. Hammer in the drywall anchors until flush with the wall (fig 3).
- Step 6. Secure the mounting brackets (with the rib facing down) to the wall using the provided screws (fig 4).
- Step 7. Insert the unit with holes facing down to the bracket and tighten setscrews with an Allen wrench until the base is tight and secure (fig 5).

Cleaning

Clean with a damp cloth only.
 Avoid using metal or abrasive polishes.



KINGSTON

KITCHEN & BATH

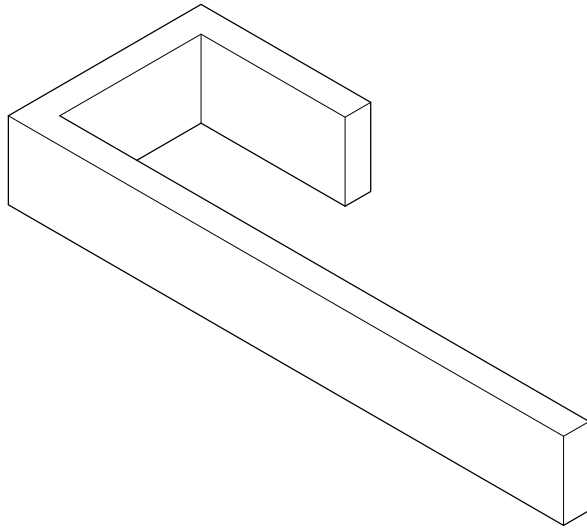
Towel Ring Installation

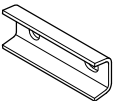
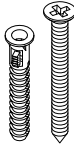

Parts:

Mounting Bracket	Mounting Screw & Anchor	Set Screw
		
1 Pc	2 Pcs	2 Pcs

CAUTION

Failure to follow all installation directions may cause product to detach from the wall and cause serious injury

www.kingstonbrass.com
 TOLL-FREE CUSTOMER SERVICE: 1-877-2-KBRASS
 TECHNICAL SUPPORT E-mail: service@kingstonbrass.com
 12775 Reservoir Street, Chino, CA 91710

TOOLS REQUIRED

 Allen Wrench

 Phillips Screwdriver

 Marking Pencil

 Hammer

 Power Drill

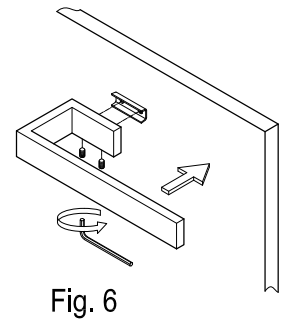
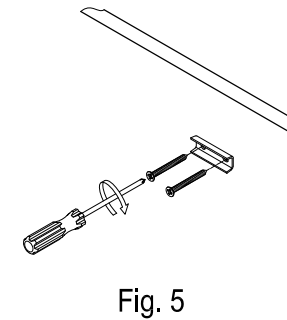
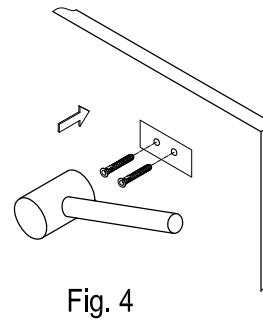
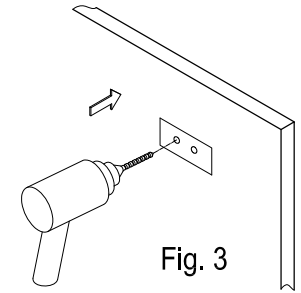
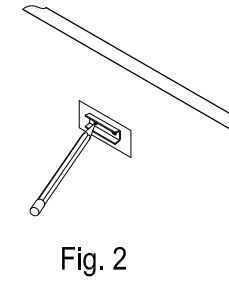
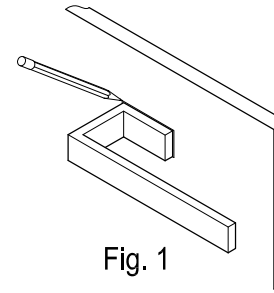

Installation Steps:

- Step 1. Locate where you would like to install the towel ring then measure the desired height on the wall where the towel ring will hang.
- Step 2. Place a base onto the wall and trace around it with a pencil (fig 1).
- Step 3. Place the mounting bracket (with the rib facing down) in the center of the pencil outline you just made and mark the location of the mounting screws (fig 2).
- Step 4. Remove the mounting bracket from wall and use a 1/4" drill bit to pre-drill holes in the drywall where pencil marks are drawn (fig 3).
- Step 5. Hammer in the drywall anchors until flush with the wall (fig 4).
- Step 6. Secure the mounting brackets (with the rib facing down) to the wall using the provided screws (fig 5).
- Step 7. Insert the unit with holes facing down to the bracket and tighten setscrews with an Allen wrench until the base is tight and secure (fig 6).

Cleaning

Clean with a damp cloth only.
 Avoid using metal or abrasive polishes.



KINGSTON

KITCHEN & BATH

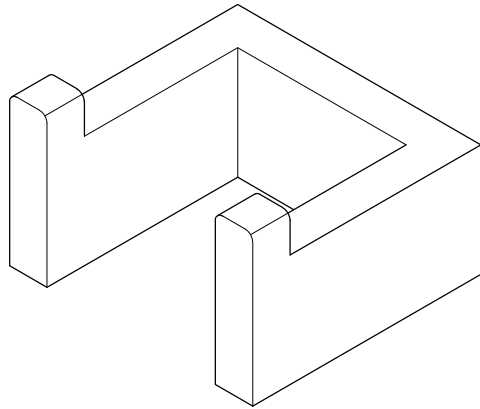
Robe Hook Installation

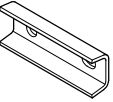
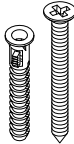

Parts:

Mounting Bracket	Mounting Screw & Anchor	Set Screw
		
1 Pc	2 Pcs	2 Pcs

CAUTION

Failure to follow all installation directions may cause product to detach from the wall and cause serious injury

www.kingstonbrass.com
TOLL-FREE CUSTOMER SERVICE: 1-877-2-KBRASS
TECHNICAL SUPPORT E-mail: service@kingstonbrass.com
12775 Reservoir Street, Chino, CA 91710

TOOLS REQUIRED

 Allen Wrench

 Phillips Screwdriver

 Marking Pencil

 Hammer

 Power Drill

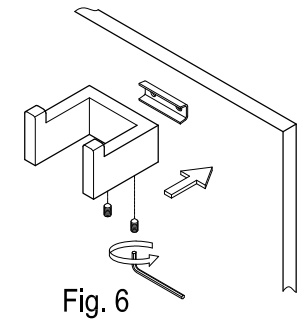
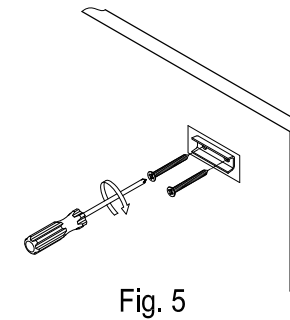
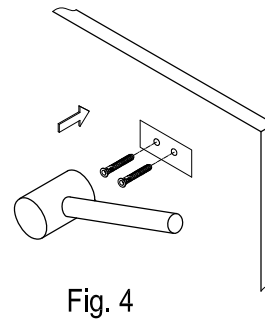
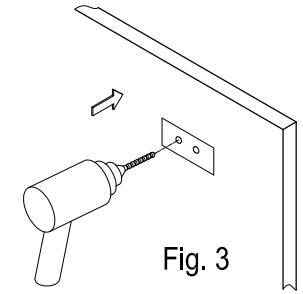
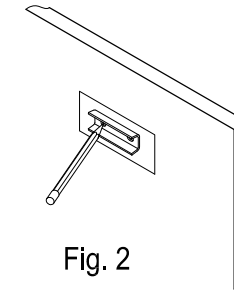
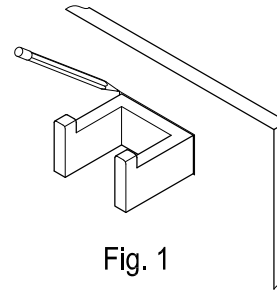

Installation Steps:

- Step 1. Locate where you would like to install the robe hook then measure the desired height on the wall where the robe hook will hang.
- Step 2. Place a base onto the wall and trace around it with a pencil (fig 1).
- Step 3. Place the mounting bracket (with the rib facing down) in the center of the pencil outline you just made and mark the location of the mounting screws (fig 2).
- Step 4. Remove the mounting bracket from wall and use a 1/4" drill bit to pre-drill holes in the drywall where pencil marks are drawn (fig 3).
- Step 5. Hammer in the drywall anchors until flush with the wall (fig 4).
- Step 6. Secure the mounting brackets (with the rib facing down) to the wall using the provided screws (fig 5).
- Step 7. Insert the unit with holes facing down to the bracket and tighten setscrews with an Allen wrench until the base is tight and secure (fig 6).

Cleaning

Clean with a damp cloth only.
Avoid using metal or abrasive polishes.



KINGSTON

KITCHEN & BATH

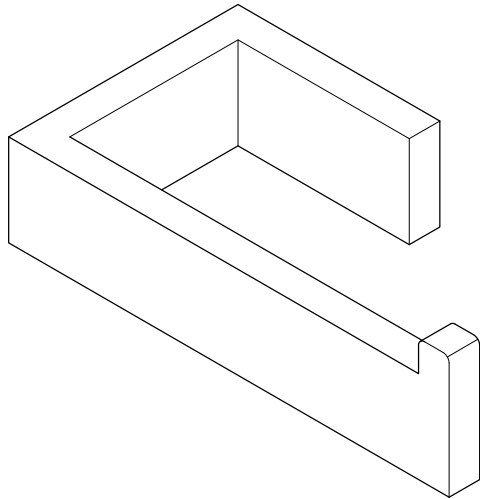
Toilet Paper Holder Installation

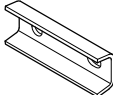
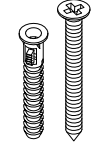

Parts:

Mounting Bracket	Mounting Screw & Anchor	Set Screw
		
1 Pc	2 Pcs	2 Pcs

CAUTION

Failure to follow all installation directions may cause product to detach from the wall and cause serious injury

www.kingstonbrass.com
TOLL-FREE CUSTOMER SERVICE: 1-877-2-KBRASS
TECHNICAL SUPPORT E-mail: service@kingstonbrass.com
12775 Reservoir Street, Chino, CA 91710

TOOLS REQUIRED

 Allen Wrench

 Phillips Screwdriver

 Marking Pencil

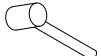
 Hammer

 Power Drill

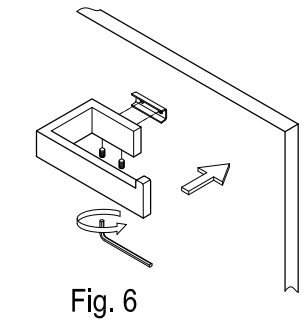
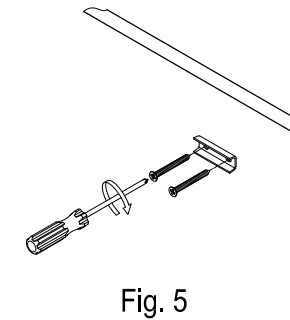
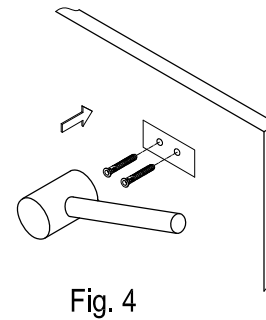
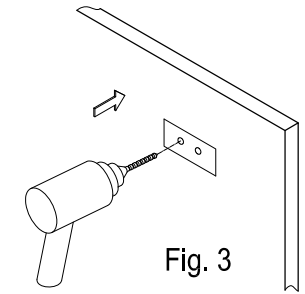
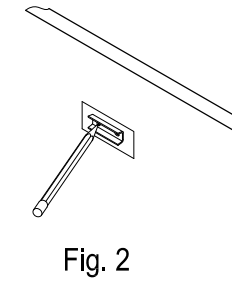
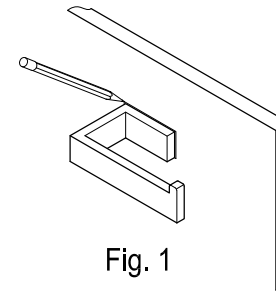

Installation Steps:

- Step 1. Locate where you would like to install the toilet paper holder.
Place a base onto the wall and trace around it with a pencil (fig 1).
- Step 2. Unscrew the set screw of the base and remove the mounting bracket.
- Step 3. Place the mounting bracket (with the rib facing down) in the center of the pencil outline you just made and mark the location of the mounting screws (fig 2).
Drill holes at the marked locations (fig 3).
- Step 4. Insert anchors into the holes with a hammer until flush with the wall (fig 4).
- Step 5. Screw the mounting bracket (with the rib facing down) to the wall with the mounting screws (fig 5).
- Step 6. Insert the unit, with the small hole in the base underneath, over the mounting bracket by tightening the set screws with an Allen wrench until the base is tightly fixed (fig 6).

Cleaning

Clean with a damp cloth only.
Avoid using metal or abrasive polishes.