

USE AND CARE GUIDE

1X2 LED FLAT PANEL FIXTURE WITH SELECTABLE COLOR TEMPERATURES

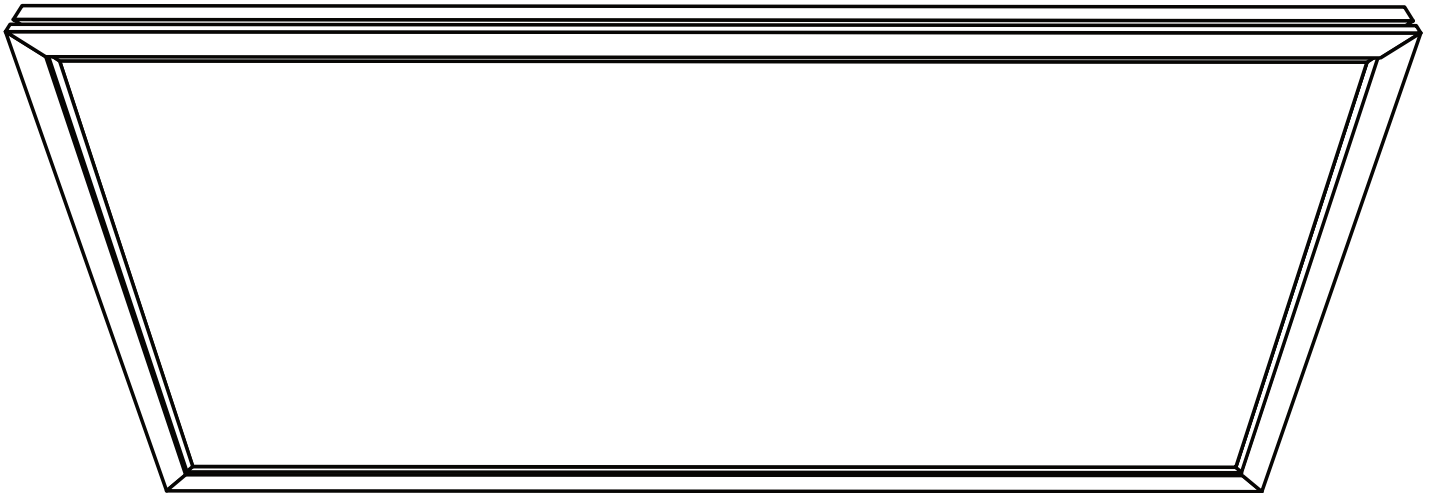

Questions, problems, missing parts?

Before returning to store, visit feit.com/help for further assistance.



Table of Contents

Table of Contents 2
Safety Information 2
Warranty 2
Pre-Installation 3
 Tools Required 3
 Hardware Included 3
Installation 4-5
Changing the Color Settings 6

Safety Information

For your safety, always remember to:

- Turn off the power supply at the fuse or circuit breaker box before you install the fixture.
- Ground the fixture to avoid potential electric shock and to ensure reliable starting.
- Double-check all connections to be sure they are tight and correct.
- Wear rubber soled shoes and work on a sturdy wooden ladder.
- Account for small parts and destroy packing material, as these may be hazardous to children.

This fixture is designed for use in a circuit protected by a fuse or circuit breaker. It is also designed to be installed in accordance with local electrical codes. If you are unsure about your wiring, consult a qualified electrician or local electrical inspector, and check your local electrical code.

 **WARNING: RISK OF SHOCK.** House electric current can cause painful shock or serious injury unless handled properly.

 **CAUTION:** Turn off the main power at the circuit breaker before installing the fixture, in order to prevent possible shock.

 **WARNING:** Changes or modifications to this unit not expressly approved by the party responsible for compliance could void the user's authority to operate the equipment.

NOTICE: All electrical connections must be in accordance with local and National Electrical Code (N.E.C.) standards. If you are unfamiliar with proper electrical wiring connections obtain the services of a qualified electrician.

Remove the fixture and the mounting package from the box and make sure that no parts are missing by referencing the illustrations on the installation instructions.

FCC STATEMENT:

This device complies with part 15 of the FCC Rules. Operation is subject to the following two conditions: (1) This device may not cause harmful interference, and (2) this device must accept any interference received, including interference that may cause undesired operation. Note: This equipment has been tested and found to comply with the limits for a Class B digital device, pursuant to part 15 of the FCC Rules. These limits are designed to provide reasonable protection against harmful interference in a residential installation. This equipment generates, uses and can radiate radio frequency energy and, if not installed and used in accordance with the instructions, may cause harmful interference to radio communications. However, there is no guarantee that interference will not occur in a particular installation. If this equipment does cause harmful interference to radio or television reception, which can be determined by turning the equipment off and on, the user is encouraged to try to correct the interference by one or more of the following measures: Reorient or relocate the receiving antenna. Increase the separation between the equipment and receiver. Connect the equipment into an outlet on a circuit different from that to which the receiver is connected. Consult the dealer or an experienced radio/TV technician for help. Any changes or modifications not expressly approved by the manufacturer could void the user's authority to operate the equipment.

Supplier's Declaration of Conformity:
47 CFR § 2.1077 Compliance Information
Responsible Party:
Feit Electric Company
4901 Gregg Road,
Pico Rivera, CA 90660, USA
Unique Identifier:
FP1X2/6WY/NK

Limited Warranty

This product is warrantied to be free from defects in workmanship and materials for up to 5 years from date of purchase. If the product fails within the warranty period, please contact Feit Electric at info@feit.com or visit feit.com/contact-us for instructions on replacement or refund. REPLACEMENT OR REFUND IS YOUR SOLE REMEDY. EXCEPT TO THE EXTENT PROHIBITED BY APPLICABLE LAW, ANY IMPLIED WARRANTIES ARE LIMITED IN DURATION TO THE DURATION OF THIS WARRANTY. LIABILITY FOR INCIDENTAL OR CONSEQUENTIAL DAMAGES IS HEREBY EXPRESSLY EXCLUDED. Some states and provinces do not allow the exclusion of incidental or consequential damages, so the above limitation or exclusion may not apply to you. This warranty gives you specific legal rights, and you may also have other rights which vary from state to state or province to province.

Pre-Installation

TOOLS REQUIRED

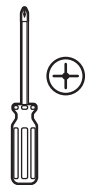

Phillips screwdriver

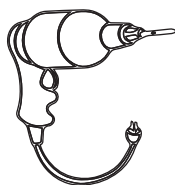

Power Drill



1/2 in. Drill Bit

HARDWARE INCLUDED



NOTE: Hardware not shown to actual size.

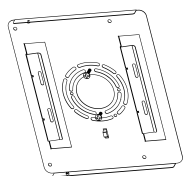

AA



BB



CC

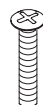

DD



EE

Part	Description	Quantity
AA	Mounting Plate (8.07 in. x 9.9 in. x 0.47 in.)	1
BB	3/16 in. Bolts	4
CC	Wire Nuts	3
DD	Screws #8-32 x 1 in.	2
EE	LED Flat Panel	1

Installation

1 Turning Off the Power

- Turn the power OFF at the switch and fusebox or the circuit breaker.

2 Identifying the Wires

- Identify the wiring: (black - line voltage, white - neutral and green - ground).

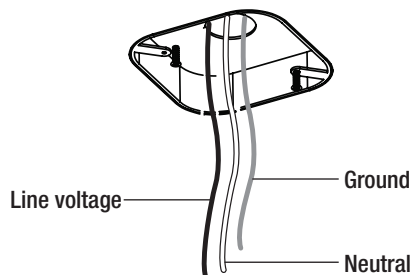

3 Attaching the Mounting Plate

- Attach the mounting plate (AA) to the junction box using the two #8-32 x 1 in. screws (DD).
- Align the mounting plate in the direction you want the fixture to be aligned. Once the toggle bolts are installed, you cannot change the orientation.

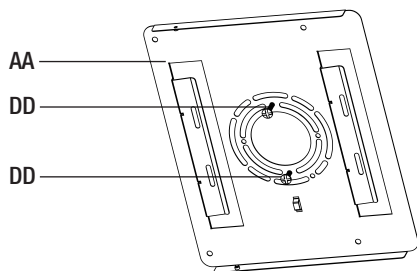

4 Positioning the Toggle Bolts

- Using the mounting plate (AA) as a guide, mark the position of the holes on the ceiling or wall where the toggle bolts will be placed.

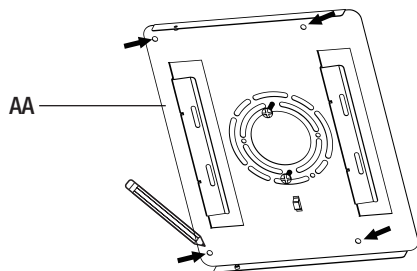

5 Securing the Toggle Bolts

- Remove the mounting plate (AA) from the junction box.
- Drill the marked locations using a 1/2 in. drill bit.
- Remove the wings from the 3/16 in. toggle bolts (BB).
- Insert a screw (BB) through the front of the mounting plate (AA) and reattach the wing to the screw (BB). Repeat for all toggle bolts.

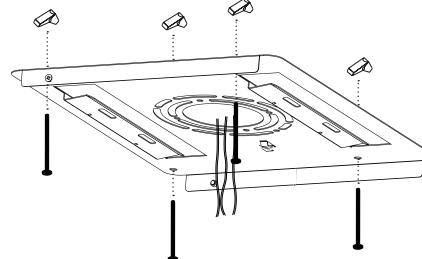

6 Re-attaching the Mounting Plate

- Feed the junction box wires through the center of the mounting plate (AA) hole.
- Re-attach the mounting plate (AA) by inserting the toggle bolts (BB) into the drilled holes.
- Once the wings (BB) are through and expanded, pull the toggle bolts (BB) downward to engage and tighten.



CAUTION: When installing the panel on a vertical surface, the mounting plate must be installed in such a way that the mounting tabs are oriented in a vertical position. If the mounting tabs are not in this position the fixture will not be properly secured and could fall resulting in serious injury.

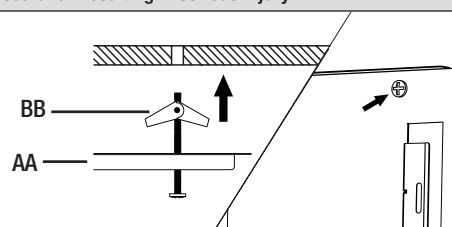

7 Connecting the Fixture

- Hook the support wire from the fixture on the mounting plate (AA).



CAUTION: Care must be taken not to have excess wires outside the junction box to avoid pinching wires. This may cause a short and could lead to a potential hazard.

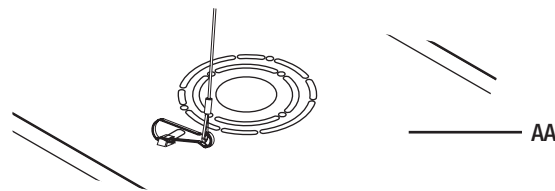

Installation (continued)

8 Installing the Fixture

- Connect the three wires coming from the fixture (EE) to the junction box wires (black - line voltage, white - neutral and green - ground).



NOTE: Before attaching the fixture, select the preferred color temperature on the back of the fixture. See "Changing Color Settings" for details.

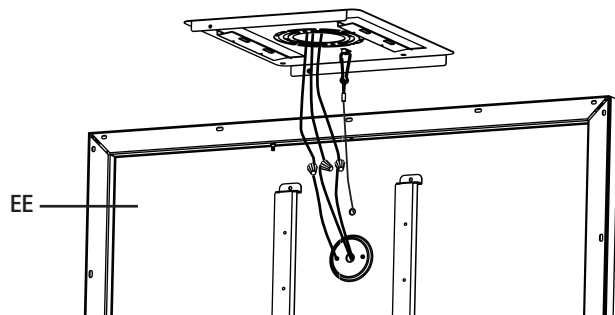

10 Attaching the Fixture

- Feed the junction box and fixture wires through the mounting bracket plate's center hole.
- Raise the fixture to the direction of the arrow on the swing arm.

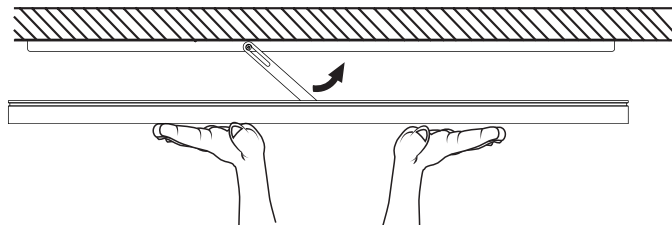

9 Connecting the Swing Arms

- Insert the swing arm's key hole slot into the mounting bracket plate's hanging screw.

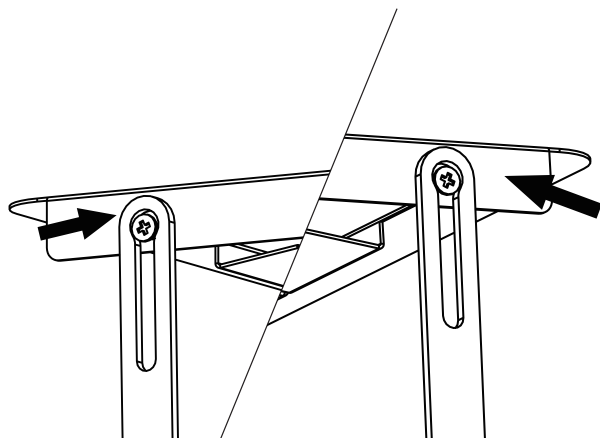

11 Securing the Fixture

- Once the fixture has been raised and is flush to the ceiling, lock the fixture by moving it towards the opposite direction it was raised.

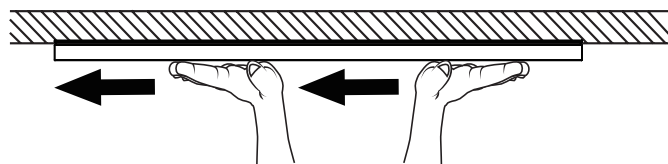

Changing Color Settings

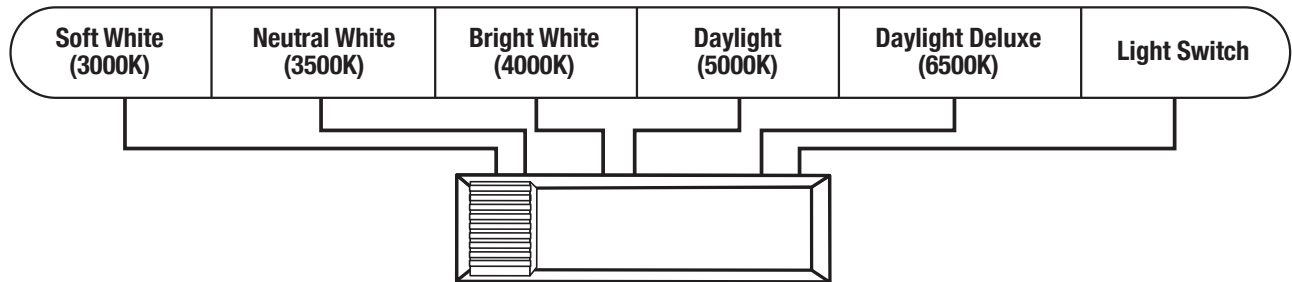

1. When the slide switch is set to 3000K, the color temperature is set to Soft White.
2. When the slide switch is set to 3500K, the color temperature is set to Neutral White.
3. When the slide switch is set to 4000K, the color temperature is set to Bright White.
4. When the slide switch is set to 5000K, the color temperature is set to Daylight.
5. When the slide switch is set to 6500K, the color temperature is set to Daylight Deluxe.
6. When the slide switch is set to SWITCH, the color temperature can be changed from 3000K, 3500K, 4000K, 5000K and 6500K with your existing light switch.
7. To change color temperatures using your existing light switch:
 - A. Set the slide switch on the back of the fixture to SWITCH.
 - B. Toggle your light switch ON and OFF within 0.5-3 seconds to cycle through the 5 different color temperatures.
 - C. If the fixture is left OFF for over 10 seconds then turned ON, the fixture will remember the last color temperature selected and will display that color when turned on again.
8. Reset function is used when operating multiple color selectable lighting products from the same light switch. In the event multiple fixtures are not displaying the same color at the same time, the fixtures must be reset using your existing light switch. Toggle the wall switch ON and OFF seven times (leave the switch in the ON position for five seconds before toggling to OFF).



Questions, problems, missing parts?

Before returning to store, visit feit.com/help for further assistance.

