

MR360UV

MARINIZED
IN-DASH DVD/MP3/CD AM/FM RECEIVER
WITH 3.6" (91mm) WIDESCREEN TFT DIGITAL MONITOR

09.2012

BOSS[®]

AUDIO SYSTEMS

3451 Lunar Court • Oxnard, CA 93030
www.bosssaudio.com
800.999.1236

tech support: www.bosssaudio.com/support



iPod[®] is a trademark of Apple, Inc.
registered in the U.S. and other countries.

USER'S MANUAL MR360UV

MARINIZED
IN-DASH DVD/MP3/CD AM/FM RECEIVER
WITH 3.6" (91mm) WIDESCREEN TFT DIGITAL MONITOR



MARINIZED

BOSS[®]

AUDIO SYSTEMS

Boss Audio Systems is not affiliated with Apple, Inc.

**To ensure safety while driving
and to comply with laws,
drivers should not watch video or
operate the video device while driving.**

6. Specification

General Specification

Power Supply Requirement.....DC 12V
Maximum Power Output.....4 x 80W(measured at DC 14.4 V)
Dimensions(w x h x d).....7"W x 2"H x 6.5"D

DVD Deck Specification

Format.....DVD/VCD/MPEG 4/JPEG//MP3/WMA/CD
Video System.....NTSC
Audio System.....24 bit/96KHz
Loading System.....Auto Loading
Mounting Angle.....0 to +/-30

Video Specification

Video Type.....16:9 and 4:3
Video Output level.....Composite:1.0± 0.2Vp-p
Load impedance: 75 ohms
Horizontal Resolution.....500

Audio Specification

Audio Output(Analog audio).....2.0⁺⁰-1.0Vrms
Frequency Response.....20Hz ~ 20KHz(at 1KHz 0 dB)
S/N Ratio(Audio).....≥90dB(at 1KHz 0 dB)
Separation.....50dB

Radio Specification

FM Section
Frequency range.....87.5MHz - 107.9MHz(US)
87.5MHz - 108.0MHz(EU)
Usable sensitivity.....3uV
I.F Frequency.....10.7MHz

AM Section
Frequency.....530KHz - 1710KHz(US)
522KHz - 1620KHz(EU)

6. The Trouble Shooting

Please read the user's manual carefully before using the DVD player. If you have any troubles in using this player, try to solve the problems by the suggestions mentioned below. If you can not remove the trouble after using all the suggestions, please contact the company or the technical service center authorized by us. For the sake of your safety, please do not open the cover and repair the player by yourself, if that, it may cause electric shock.

NO PICTURE, SOUND AND INDICATION

- * Ensure that the power switch is on.
- * Ensure that the fuse is not blown.

NO SOUND BUT HAVE PICTURE

- * Ensure that the player's audio output has a good connection with TV's audio input.
- * Check whether the audio connector is damaged.
- * Check whether you have turned down the volume.
- * Ensure that you have set the right AUDIO setup of the player.
- * Ensure that the audio is not under mute.

NO PICTURE BUT HAVE SOUND

- * Ensure that the player's video output has a good connection with TV's video input.
- * Ensure that you have turned your TV to the AV input channel connecting to your player.
- * Ensure that you have set the right VIDEO settings of the player.

BLACK AND WHITE PICTURE OR SCREEN ROLLING

- * Ensure that you have set the right TV SYSTEM (e.g. PAL, NTSC) setting.

FLAWS OF PICTURE OR SOUND

- * Check whether the setting of AUDIO is right.
- * Check whether the disc is scratched or stained.
- * Check whether there is condensation inside the Lens. If so, leave the player off for an hour or so, then try again.
- * Check whether the installation angle is less than 30°.

DISPLAY NO DISC OR BAD DISC

- * Ensure that you have put the disc on the tray.
- * Check whether the disc is put in the reverse side.
- * Check whether the disc is distorted.
- * Check whether the disc is stained or scratched badly.
- * Ensure that the disc format is compatible to the player.
- * Ensure that the temperature inside the case is not too high. If so, cool off until the ambient temperature returns to normal.
- * Replace another disc to insert it into the disc compartment.

REMOTE CONTROL IS INSENSITIVE OR DOES NOT WORK

- * Check the batteries of remote control and make sure that they are to be powerful and good conductivity.
- * Direct the remote control to the IR sensor of the player.
- * Check whether there are some obstacles between the remote control and IR sensor.

SOME FUNCTION BUTTONS DO NOT WORK

- * Turn off the power, then turn on again.
- * Reset the unit to zero, then turn on again.
- * Remove the front panel from the unit, then install it again and then turn on again.

THE RADIO DOES NOT WORK

- * Check whether the antenna cable is connected firmly. Or manually tune for a station.

PRECAUTION

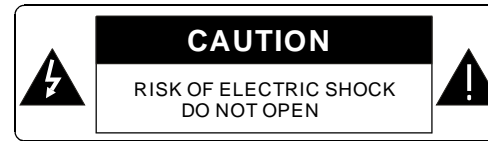

WARNING: TO REDUCE THE RISK OF FIRE OR ELECTRIC SHOCK, DO NOT EXPOSE THIS APPLIANCE TO RAIN OR MOISTURE.

CAUTION: TO REDUCE THE RISK OF ELECTRIC SHOCK, DO NOT REMOVE COVER (OR BACK). NO USER SERVICEABLE PARTS INSIDE. REFER SERVICING TO QUALIFIED SERVICE PERSONNEL.



The lightning flash with arrowhead symbol, within an equilateral triangle, is intended to alert the user to the presence of uninsulated dangerous voltage within the product's enclosure that may be of sufficient magnitude to constitute a risk of electric shock to persons.



The exclamation point within an equilateral triangle is intended to alert user to the presence of important operating and maintenance (servicing) instructions in the literature accompanying the appliance.

CLASS 1 LASER PRODUCT

Laser product symbol: located on the rear panel of the unit, indicate this player is a class laser product, only use weak laser and no hazardous radiation outside of the unit.

1. Read through this instruction manual before installation and use.
2. Do not open the cover or touch any of the components exposed out of the unit, only for qualified technicians.
3. Do not expose the unit under direct sunlight or nearby objects that radiate heat to avoid damage the unit.
4. Do not place the unit in moist and humid conditions, which effect the pick-up of the unit lead to out of work.
5. Place the unit on a flat surface and ventilative condition. Please ensure the ventilation holes are not covered to avoid overheating and malfunction.
6. Clear the panel and case with soft dry cloth only, do not apply any kind of thinner, alcohol or sprays.

Contents

1. Before Operation.....	4
1.1 Glossary.....	4
1.2 Precautions.....	4
1.3 Maintenance and Cleaning of Discs.....	5
1.4 Battery Information of the Remote Control.....	5
1.5 The Remote Control Description.....	6
1.6 Locations and Names of the Controls.....	7
1.7 Description of the Rear Cabinet.....	8
1.8 Unit Installation.....	9
2. Common Operation.....	10
3. Radio Operation.....	12
4. Basic Disc, USB or MMC/SD Operation.....	14
4.1 Begin Playback.....	16
4.2 Pause Playback.....	16
4.3 Stop Playback.....	16
4.4 Select Chapter/Track with the UP/DN or the >> << Buttons.....	16
4.5 Select Chapter/Track with the Number Buttons.....	16
4.6 Select Chapter/Track with the Root/PBC Menu.....	16
4.7 Terminate the Playback.....	17
4.8 Playback with Speed.....	17
4.9 Playback with Slow Speed.....	17
4.10 Playback with Still Frame.....	18
4.11 Playback Repeatedly.....	18
4.11.1 One/All Repeat.....	18
4.11.2 A-B Repeat.....	18
4.12 Playback in Scan Mode.....	19
4.13 Playback from a specified Chapter/Track or a Specified Time.....	19
4.14 Playback in Random.....	19
4.15 Playback in Different Angle.....	19
4.16 Playback in Zoom Mode.....	19
4.17 Change the Caption Language.....	20
4.18 Change the Audio Language.....	20
4.19 Look over the Playback Status.....	20
4.20 Program Playback.....	21
4.21 Playback the Picture CD in JPEG Format.....	21
4.22 Operation about file style of video.....	22
4.23 ESP and ID3 Function.....	22
4.24 USB and MMC/SD Reader Operation.....	22
4.25 The DVD System Menu Setup Operation.....	22
4.26 The Parental Control.....	27
4.27 The Region Code.....	28
5. Trouble Shooting.....	29
6. Specification.....	30

4.27 The Region Code

Q: Not begin to playback but to display REGION ERROR after inserting disc into disc compartment. Why ?

A: Because the DVD player and disc has respective region code. If the region codes of them are not match with each other, the DVD player can not play the disc.

Appendix: The region code of DVD:

The Motion Picture Association of America (MPAA) divided the world into 6 regions, and named every region a code, namely region code. The region codes and the countries or areas represented by the region codes are as follows:

- Region 1: America, Canada, East-Pacific Inlands;
- Region 2: Japan, West Europe, North Europe, Egypt, South Africa, Middle East;
- Region 3: South-east Asian countries include Taiwan, Hong Kong, South Korea, Thailand, Indonesia, etc.;
- Region 4: Australia, New Zealand, Central South America, South Pacific Inlands;
- Region 5: Russia, Mongolia, Indian Peninsula, Middle Asia, East Europe, North Korea, North Africa, North-west Asia etc.;
- Region 6: China mainland.

Basically, when a DVD movie disc for the version of region 6 was decided not to issue, we need to purchase another DVD player that can play the DVD movie disc for the version of non-region 6. In order to view this disc, viewer who does not have the non-region 6 DVD player facilities will have to spend extra sum of money to buy it. The problems caused from the area code inconsistency between the disc and the DVD player has pushed for the production of Unlock-Version DVD player facilities, and some DVD disc sets allow user to modify the area codes for a limited number of times. But note that only the discs produced by the 8 biggest filmmaking companies of America restrict so, they are not one of original DVD format. That is to say, the DVD movie discs not produced by the 8 biggest filmmaking companies of America were not restricted by the rule of region code. Generally, they are called FreeRegionCode discs or Full Region discs. The 8 biggest filmmaking companies of America are as follows:

1. WarnerBros;
2. Columbia;
3. 20thCenturyFOX;
4. Paramount;
5. Universal;
6. UA(UnitedArtist);
7. MGM(MetroDogwynMayer);
8. WaltDisney

4.26 The Parental Control

Q: After inserting DVD disc into disc compartment, it will appear a dialogue window that ask me input a password of 4 digit. Why ?

A: This is because that the disc movie you are playing was rated with the Parental Control, and the current rating level of DVD player is lower than one of current disc. You must input right password and enter it to entry Parental Control setup menu and then set a equal or higher rating level than one of current disc. So that you can playback the disc.

NOTE

- * If you have not changed the password, the factory preset password for the DVD player will be empty. So that you should input a desired password and input it again to verify it to enter the Parental Control setup menu.
- * For the rating level setup of Parental Control of the DVD player, please refer to the relative content of LOCK setup menu for details.

Accessories: Parental Control

The Parental Control function of a DVD player can control the playback of movie rated level in a disc. Can set the DVD player(include software player in PC) to be a certain rating level with SETUP MENU on TV screen. If the rating level set in the disc is higher than one set in the DVD player, the DVD player can not playback the disc. Sometimes the Parental Control sequences in some discs are different from each other. The rating level setup can be protected by the password. Therein, if you select Unlock item, the Parental Control function will be invalid, the content of disc will be played totally.

The disc movie can be designed as that the DVD player will playback the different version of content of a same movie according to the different rating level set by Parental Control. Depend on the DVD feature of seamless switching described above, the scenes that are not fitting for children will be cleared or replaced by the other fitting scene automatically.

All rating levels of Parental Control are as follows:

- | | |
|---|----------|
| | Unlock |
| 1 | Kid Safe |
| 2 | G |
| 3 | PG |
| 4 | PG 13 |
| 5 | PG R |
| 6 | R |
| 7 | NC 17 |
| 8 | Adult |

1. Before Operation

1.1 Glossary

PBC (playback control)

It is a kind of signal(menu) recorded in the disc with SVCD or VCD2.0 format used for the playback control. For the discs contained PBC, It can playback interactive software with the menu displayed on TV.

Title

Generally, the title is the important part of DVD disc. for example, the theme part of movie is title 1, the part described how to make movie is title 2, the cast is title 3, etc. Every title contain a serial number that is easy to lookup.

Chapter

A title can be divided into several blocks, so that every block can be operated as a unit, the unit is called chapter. The chapter contain a unit at least.

Track

It is the biggest component of VCD. Generally, every song of karaoke disc is a track.

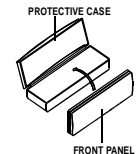

1.2 Precautions

Safety

1. The unit is designed for negative terminal of the battery which is connected to the vehicle metal. Please confirm it before installation.
2. Do not allow the speaker wires to be shorted together when the unit is switched on. Otherwise it may overload or burn out the power amplifier.
3. Do not install the detachable panel before connecting the wire.
4. The protective case is to safely keep the front panel(see the photo).

Environment

1. Do not use this unit when water and moisture is near it.
2. If moisture forms inside the Lens, it may not operate properly. To correct this problem, wait about one hour for the moisture to evaporate.
3. If the car interior is extremely hot, do not use the player until the car has been driven for a while to cool off the interior.

1.3 Maintenance and Cleaning of Discs

Disc Maintenance

1. To keep the disc clean, handle the disc by its edge, do not touch the disc surface of the play side.
2. Do not stick paper or tape on the disc. If there is glue (or analog) on the disc surface, must wipe it up before using.
3. Do not expose the disc to direct sunlight, or nearby heat sources such as caliduct, or leave it in a car parked in direct sunlight where there can be a considerable rise in temperature.
4. Put the disc inside disc case to keep temperature after finishing playback.

Disc Cleaning

1. Before playing, wipe the disc with a clean lint. wipe the disc outwards from the disc center.
2. Do not use petrol, thinner, commercially cleaner or anti-static spray used to plastic LP to wipe disc.

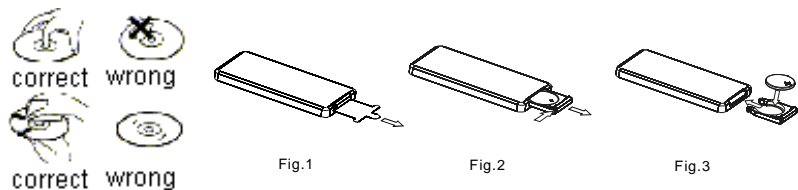

Fig.1

Fig.2

Fig.3

1.4 Battery Information of the Remote Control

Replace Battery in the Remote Control:

1. Before using the remote control for the first time, pull the insulating sheet out of the remote control as the direction indicated by the arrow. (see fig.1)
2. Press the movable block hold as the direction indicated by the A arrow (See fig.2), then pull the battery holder out of the remote control as the direction indicated by the B arrow (see fig.2).
3. Replace the old battery by a new battery with (+) polarity side upward. (See fig.3).
4. Insert the battery holder to the original position in remote control. (See fig.3).

Note about the Battery of the Remote Control:

1. Improper use of battery may cause overheating or explosion. so that Result in injury or fire .
2. Battery leakage may cause damage to the remote control (Battery Life: 6 months with normal use in normal room temperature).
3. Do not short the battery.
4. Do not throw the battery into the fire.
5. To avoid the risk of accident, keep the battery out of reach of children.

4.25.6 DIGITAL SETUP



OP MODE

It is for selecting audio output mode

DYNAMIC RANGE

After selecting the compression mode of LINE OUT, set the item, so you can adjust the linear compression ratio. If you set it to be FULL, the Peak-to-Peak value of the audio signal is the minimum; if you set it to be OFF, the Peak-to-Peak value is the maximum.

DUAL MONO

It is for selecting a desired audio output mode for the left and right ways of signal. It is mainly for Karaoke of Ac3. There are 4 modes in all as follows: STEREO, MONO L, MONO R, MIX MONO.

4.25.4 VIDEO SETUP



BRIGHTNESS

It is for adjusting the brightness of the video output.

CONTRAST

It is for adjusting the contrast of the video output.

SATURATION

It is for adjusting the saturation of the video output.

HUE

It is for adjusting the hue of the video output.

4.25.5 SPEAKER SETUP



DOWNMIX

It is for selecting your desired sound effect when there is no center speaker and subwoofer. There are 3 modes: LT/RT, STEREO, VSS.

LT/RT: When playing a media with stereo effect, choose the item, so it will output audio signal with vivid theatre effect.

STEREO: If you choose the item, when outputting audio signal with 5.1 channels, it will output the left and right channels of signal ; when outputting audio signal with 2 channels, it will output the common 2 channels of stereo signal.

VSS: If you choose the item, when playing a media recorded with 5.1 channels, the main channel speakers can output audio signal with VSS effect.

1.5 The Remote Control Description

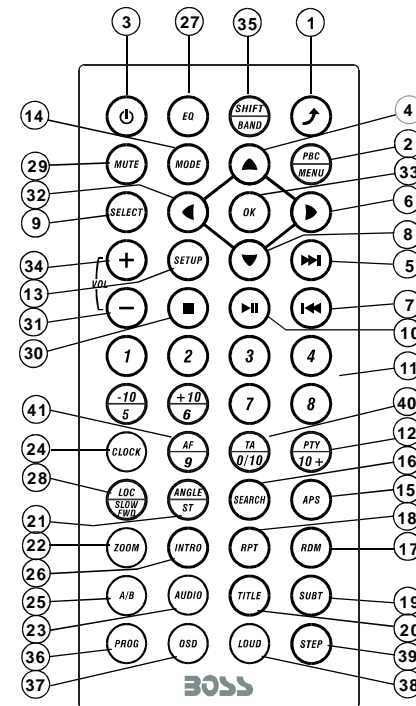

- | | |
|-------------------------|-------------------------------------|
| 14. MODE BUTTON | 1. BACK BUTTON |
| 15. APS BUTTON | 2. MENU/PBC BUTTON |
| 16. SEARCH BUTTON | 3. POWER BUTTON |
| 17. RDM BUTTON | 4. ^ BUTTON |
| 18. RPT BUTTON | 5. >> BUTTON |
| 19. SUBTITLE BUTTON | 6. > BUTTON |
| 20. TITLE BUTTON | 7. << BUTTON |
| 21. ANGLE/ST BUTTON | 8. v BUTTON |
| 22. ZOOM BUTTON | 9. SEL BUTTON |
| 23. AUDIO BUTTON | 10. PLAY/PAUSE BUTTON |
| 24. CLK BUTTON | 11. NUMBER(0~10,+10
-10) BUTTONS |
| 25. A-B BUTTON | 12. 10+/PTY BUTTON |
| 26. INT BUTTON | 13. SETUP BUTTON |
| 27. EQ BUTTON | 14. MODE BUTTON |
| 28. LOC/SLOW-FWD BUTTON | 15. APS BUTTON |
| | 16. SEARCH BUTTON |
| | 17. RDM BUTTON |
| | 18. RPT BUTTON |
| | 19. SUBTITLE BUTTON |
| | 20. TITLE BUTTON |
| | 21. ANGLE/ST BUTTON |
| | 22. ZOOM BUTTON |
| | 23. AUDIO BUTTON |
| | 24. CLK BUTTON |
| | 25. A-B BUTTON |
| | 26. INT BUTTON |
| | 27. EQ BUTTON |
| | 28. LOC/SLOW-FWD BUTTON |
| | 29. MUTE BUTTON |
| | 30. STOP BUTTON |
| | 31. VOLUME- BUTTON |
| | 32. < BUTTON |
| | 33. OK BUTTON |
| | 34. VOLUME+ BUTTON |
| | 35. BAND/SHIFT BUTTON |
| | 36. PROG BUTTON |
| | 37. OSD BUTTON |
| | 38. LOUD BUTTON |
| | 39. STEP BUTTON |
| | 40. TABUTTON |
| | 41. AF BUTTON |

1.6 Locations and Names of the Controls

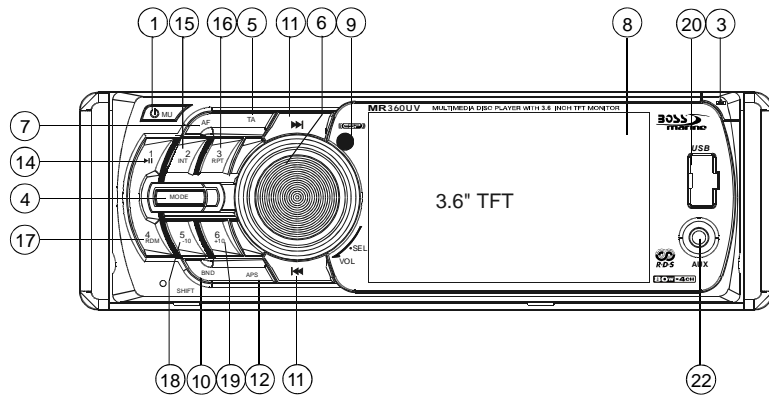

The figure of the front panel

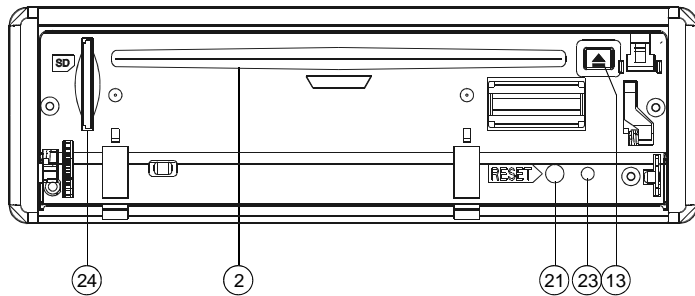

The figure of the Unit Chassis Facet After removing the Front Panel

- | | |
|-------------------------|-------------------------|
| 1. POWER/MUTE BUTTON | 13. EJECT BUTTON |
| 2. DISC SLOT | 14. 1/PLAY/PAUSE BUTTON |
| 3. RELEASE BUTTON | 15. 2/INT BUTTON |
| 4. MODE | 16. 3/RPT BUTTON |
| 5. TA BUTTON | 17. 4/RDM BUTTON |
| 6. SEL BUTTON | 18. 5/-10 BUTTON |
| AND VOL KNOB | 19. 6/+10 BUTTON |
| 7. AF BUTTON | 20. USB SOCKET |
| 8. SMALL MONITOR | 21. RESET BUTTON |
| 9. IR REMOTE SENSOR | 22. AUX IN SOCKET |
| 10. BAND BUTTON | 23. LED INDICATOR |
| 11. >>I AND I<< BUTTONS | 24. SD CARD SLOT |
| 12. APS BUTTON | |

4.25.2 LANGUAGE SETUP

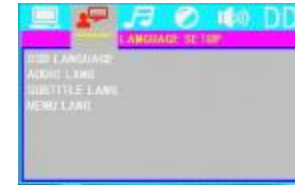

OSD LANGUAGE

This item is for selecting the language of the SYSTEM MENU and all operating prompt interface displayed during playback.

AUDIO LANG

This item is for selecting a audio language.

SUBTITLE LANG

This item is for selecting a subtitle language.

MENU LANG

This item is for selecting a menu language.

4.25.3 AUDIO SETUP



KEY

It is for selecting your desired basic music tone(from low to high).

For the DVD System Menu, there are 6 setup pages in all. They display as follows:

4.25.1 SYSTEM SETUP



TV TYPE

The setup item is for matching TV screen size.

- 4:3 PS: Choose the item when connecting a TV set with 4:3 screen. When playing the pictures with 16:9 size, the left and right parts of the video will be cut out, and display in full screen.
- 4:3 LB: Choose the item when connecting a TV set with 4:3 screen. When playing the pictures with 16:9 size, the top and bottom parts of the TV screen will be turned into a black square respectively.
- 16:9: Choose the item when connecting a TV set with 16:9 wide screen.

PASSWORD

This setup item is for locking or unlocking the rating level of the Parental Control. The defaulted state is locked. The defaulted password is 0000. You can set a new password that you like: Select the PASSWORD item and then press the > button to enter it, then input the original password 0000, and then press the OK button to unlock it. Press the > button to enter it again, then input a new password that you like and then press the OK button to make it effective. Before the other persons see the Manual, you should get the password in mind and cut out the part of PASSWORD in the Manual.

RATING

The item is for setting a new rating level of the Parental Control.

1. Select the PASSWORD item and then press the > button to enter it, then input the password mentioned above, and then press the OK button to unlock the setting of the rating level of the Parental Control.
2. Select the RATING item and then press the > button to enter it, then use the direction buttons to select your desired rating level, then press the OK button to confirm.
3. Select the PASSWORD item again and then press the > button to enter it, then input the password, and then press the OK button to lock the new setting of the rating level of the Parental Control.

DEFAULT

This item is for making all setup items change back to original status.

1.7 Description of the Rear Cabinet

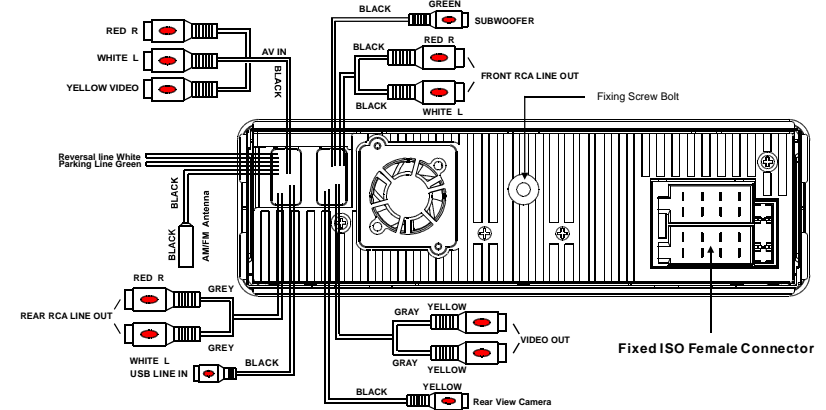

Note: After connecting the Parking Line, the video on the small monitor of the front panel will be display only after braking the car.

Connecting the parking brake line to the parking brake system built in the car

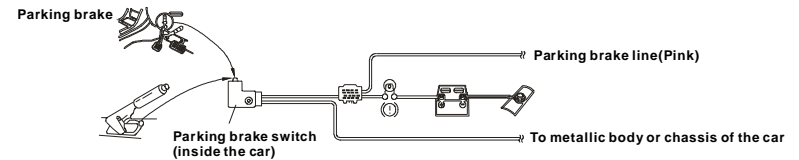

The Description of the Fixed ISO Female Connector

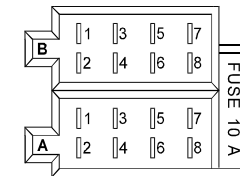

CONNECTOR A

- 1.
- 2.
- 3.
4. Memory +12V
5. Auto Antenna
- 6.
7. 12V (To Ignition Key)
8. GROUND

CONNECTOR B

1. Rear Right Speaker (+)
2. Rear Right Speaker (-)
3. Front Right Speaker (+)
4. Front Right Speaker (-)
5. Front Left Speaker (+)
6. Front Left Speaker (-)
7. Rear Left Speaker (+)
8. Rear Left Speaker (-)

1.8 UNIT INSTALLATION

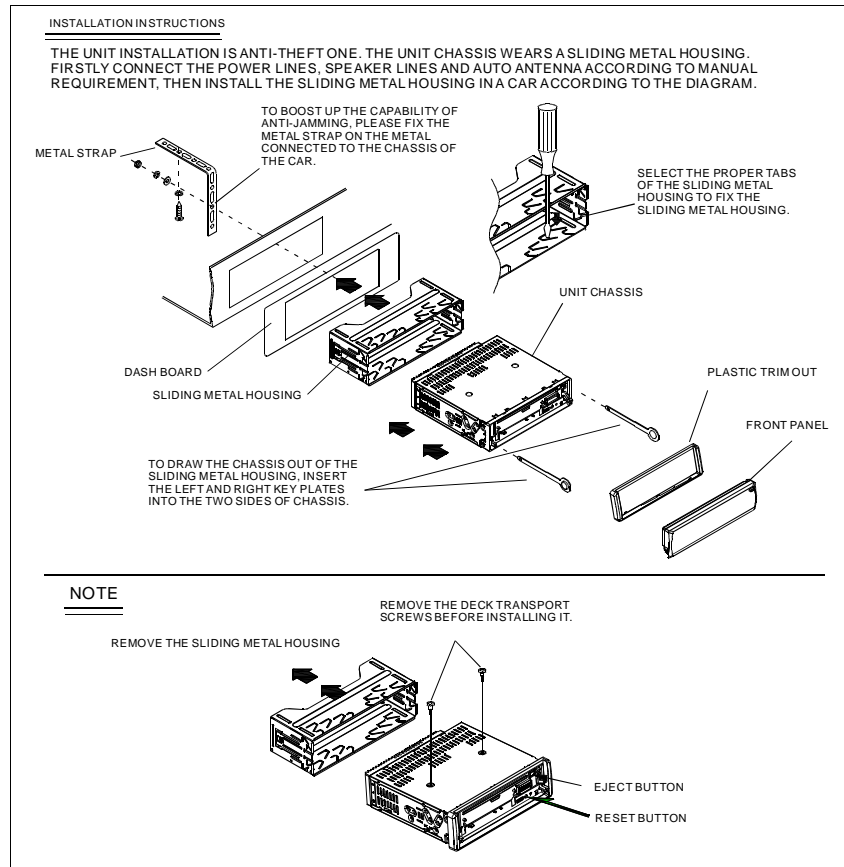

To demount the front panel

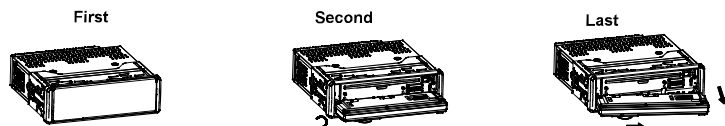

To mount the front panel

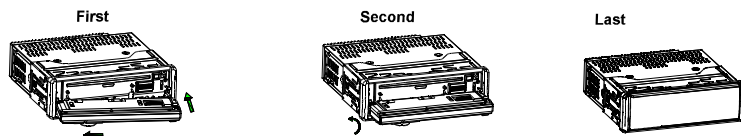

- During JPEG playback, press one of the >/</^/v buttons to change the angle of viewing picture that is displaying as follows:
 >: 90 deg cw; <: 90deg ccw; ^: UP<-->DOWN; v: LEFT<-->RIGHT
 During JPEG playback, press the PROG button to change the mode of refresh picture.
 During JPEG playback, press the STOP button to stop playing and return to the root menu.
- During JPEG playback, the following buttons are not available: SLOW-FWD, SUBTITLE, TITLE, ANGLE, STEP, AUDIO, RDM, INT and A-B.
- In JPEG mode, the other operations are same as ones in MP3/WMA mode.

4.22 Operation about file style of video

- The root menu is displayed on TV when beginning to switch on DISC mode, then it will automatically play the first file.
 During playback, press the STOP button to stop playing and return to the root menu.
- When displaying the root menu, press the direction buttons to select your desired FOLDER or file, then press the OK or PLAY button to open the FOLDER, or play the selected file.
 When displaying the root menu, you can also use the number buttons to select the serial number of the file and play the file.
- The ANGLE, PROG, RDM, INT and TITLE/PBC button are not valid.
- The other functions are same as ones in DVD disc; but the RPT function is same as one in MP3/WMA.

4.23 ESP and ID3 Function

There is ESP function for all formats of discs.

In MP3/WMA mode, during playback, the information of the file name, folder name, song's title, artist and album will be scrolling on the LCD display. As long as the current playing MP3 music contains relevant ID3 tag information in version 1.0/2.0 format, the 3 items underlined above will be scrolling on the LCD display; otherwise, they will not.

4.24 USB and MMC/SD Reader Operation

Power on the unit, then insert the USB storage or MMC/SD Card (firstly flip down the front panel), and then the monitor will display the root menu of the USB storage or MMC/SD Card.

All the operations are same as ones of the corresponding format.

When you want to pull out the Card, firstly push it, and then pull it out.

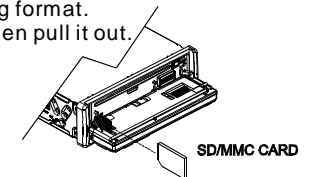

4.25 The DVD System Menu Setup Operation

- Press the SETUP button on the remote controller to access the DVD System Menu on the monitor.
- There are 6 setup pages in all for the System Menu. Press the > or < button to select an desired setup page.
- Press the ^ or v button to select an setup item in the selected setup page.
- Press the > button to enter the setup item. Then press the v or ^ button to select a desired mode of the setup item, finally press the OK button to confirm it.
- Press the < button to return to the upper level.
- Press the SETUP button again or use the direction buttons to highlight the item of the EXIT SETUP and then press the OK button to exit the System Menu.

4.20 Program Playback

It allows you to enter the order in which you want some chapters/tracks in DVD/VCD/MP3/WMA/CD disc to play.

- 1 During playback, press the PROG button to enter a program interface as follows:



- 2 Use the direction buttons to move cursor onto the desired place for inputting the sequence number.
 - 3 Use the number button to input desired sequence number of title/chapter/track with desired sequence.
 - 4 Use the direction button to move cursor onto Play item, then press the OK button to play the programmed titles/chapters/tracks in programmed order; only pressing the PLAY button also can play the programmed titles/chapters/tracks in programmed order.
- * To exit program playback, firstly press the STOP button, then press the PLAY button to enter sequence playback; or press the PROG button twice again.
 - * To remove the all programmed sequence numbers, move the cursor onto Clear item, then press the OK button.
 - * To change the programmed sequence, move the cursor onto the item you want to change, input the desired sequence number.
 - * During VCD playback, if it is in PBC ON mode, at the same time of entering the state of program playback, it turns off PBC mode.

4.21 Playback the Picture CD in JPEG Format

1. The root menu is displayed on the monitor when beginning to switch on DISC mode. At the time, it plays MP3/WMA file.(the TITLE or MENU button is not available).
In the root menu, the left file sort icon is for MP3/WMA file; the middle file sort icon is for JPEG file; the right file sort icon is for VIDEO file. If one of these 3 file sort does not exist, you can not move cursor onto the file sort icon.
2. When displaying the root menu, press the direction buttons to select your desired FOLDER, file or file sort icon, then press the OK or PLAY button to open the FOLDER, or play the selected file, or play only this sort of file.
When displaying the root menu, you can also use the number buttons to select the serial number of the file and play the file.
When you select a JPEG file sort icon, press the ^ or > button to select the first JPEG file, then press the v button to select the desired JPEG file, finally press the OK or PLAY/PAUSE button to display the JPEG picture in full screen from the selected JPEG picture.

2. Common Operation

1. To turn on/off the unit
Under power off mode, press the POWER button to turn on the unit.
Under power on mode, press and hold the POWER button on the front panel or briefly press the POWER button on the remote control to turn off the unit.

2. To select function mode
Press the MODE button to select TUNER, DISC(After inserting a disc), USB (After inserting a USB storage), Card(After inserting a MMC or SD card) or AUX mode.



Mode Menu

Press and hold the BAND button to turn on shift then rotate the VOL knob or the direction buttons to select function mode; you can also use the direction buttons to select function mode and press OK to confirm.

During playing, select the  to up to the main Menu.

Press and hold the MODE button the display can be turned off but the unit keeps working, when we press whatever button it returns on.

Note: This unit has front and rear USB. Only one will work at a time.

3. To adjust sound level
Rotate the VOL knob or press or hold the + or - button to directly adjust the volume level.
4. To mute sound
Press the MUTE button on remote control to turn on/off MUTE mode.
Briefly pressing the POWER button on the front panel also can turn on/off MUTE mode.
5. To display the time
Press the CLK button on remote controller to display clock time on the small monitor of the front panel in DISC/USB/SD-MMC modes, while under RADIO mode it is always displayed.
6. To select a preset EQ mode
Press the EQ button to select the preset music equalizer curves: FLAT, CLASSIC, ROCK, POP, EQ OFF. The sound effect will be changed.
7. To remove the front panel
Press the REL button on the front panel to detach the front panel from the unit, then you can remove the front panel.
8. To turn on/off LOUDNESS mode
Press the LOUD button to turn on/off LOUDNESS mode.
When turning on LOUDNESS mode, it will enhance bass level immediately when the bass is not enough.

9. Return control

When media playing, press the  button to up to the previous menu, press menu to up to the previous menu till to the main menu.(When playing Video, please press stop button first)

10. To reset the unit

when the display is incorrect, or the function buttons are not effective or sound is distorted, press the REL button to detach the front panel from the unit and remove it, then use the sharp end of a thing to press the RESET button, which will reset to factory default, and re-instate the correct functions.

11. To adjust sound modes

To adjust the sound modes, briefly and repeatedly press the SEL button on the front panel to select one of the sound modes such as : VOL, BAS(without preset EQ), TRE (without preset EQ), BAL, FAD.

12. To do setup

In setup mode, select the GENERAL, CLOCK, AUDIO, VIDEO, RADIO (rotate the volume tune or the direction buttons)as follow:

GENERAL SETUP

Wallpaper: this function allows to choose the display background.

Logo: this function allows to choose the starting screen.

Beep: choose the buttons' sound on/off

CLOCK SETUP

Clock mode: select 24 HOUR or 12 HOUR.

Clock time: adjust the clock.

AUDIO SETUP

Loud: choose between Loudness ON/OFF.

EQ: choose between the different types of EQ.

VIDEO SETUP

Standard Video: After setting brightness, contrast, saturation, hue, tap it to turn to the preset mode.

Brightness

Contrast

Saturation

Hue

RADIO SETUP

Radio region: choose the radio zone.

RDS setting: ON/OFF

Note: Press and hold the BAND to turn on SHIFT to do select all the function by the rotate VOL, after selecting, press the SEL to confirm, or you can also use the direction buttons to do selecting.



GENERAL SETUP



CLOCK SETUP

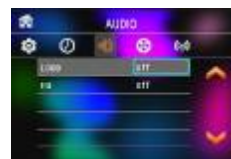

AUDIO SETUP



VIDEO SETUP



RADIO SETUP

ZOOMx2,ZOOMx3,ZOOMx4,ZOOMx1/2,ZOOMx1/3,ZOOMx1/4,ZOOM OFF.
Press one of the $\wedge/v/>/<$ buttons to select the area you want to enlarge.

4.17 Change the Caption Language

In the state of DVD disc playing, press the SUBTITLE button repeatedly to select the language of the caption or turn off the caption.(depend on the disc used.)

In the state of VCD/MP3/WMA/CD disc playing, the button is not available.

4.18 Change the Audio Language

1. In the state of DVD disc playing, press the AUDIO button repeatedly on the IR remote controller to select the desired language type.

(depend on the disc used)

2. In the state of VCD disc playing, press the AUDIO button repeatedly to select the sound mode of the MONO L, MONO R, MIX MONO and Stereo, no language function.

3. In the state of CD/WMA/MP3 disc playing, the AUDIO button is invalid.

4.19 Look over the Playback Status

1. In the state of DVD disc playing, press the OSD button repeatedly on the remote controller to turn on/off the playback status. When it is on, it will display the information such as: the serial number of the playing title, the serial number of the playing chapter, the elapsed time of the playing chapter, the remained time of the playing chapter, the elapsed time of the playing title, the remained time of the playing title, etc.

2. In the state of VCD/CD disc playing, press the OSD button repeatedly on the remote controller to turn on/off the playback status. When it is on, it will display the information such as: the serial number of the playing track, the elapsed time of the playing track, the remained time of the playing track, the elapsed time of the disc, the remained time of the disc.

3. In the state of MP3/WMA disc playing, press the OSD button repeatedly on the remote controller to turn on/off the playback status. When it is on, it will display the information such as: the serial number of the playing track, the elapsed time of the playing track, the remained time of the playing track.

4.12 Playback in Scan Mode

1. In the state of VCD(PBC OFF)/CD disc playing, press the INT button to play the previous 15 seconds part of each track on the disc. Press the INT button again to resume normal playback.
2. In the state of DVD/MP3/WMA disc playing, the INT button is not available.

4.13 Playback from a specified chapter/track or a specified time

1. In the state of DVD disc playing, press the SEARCH button to display a interface and highlight the title item, then use the number buttons to input the serial number of the title; use the direction buttons to highlight the chapter item, then use the number buttons to input the serial number of the chapter; you can still use the direction buttons to highlight the time item, then use the number buttons to input the desired time to start playback; finally press the OK or PLAY button to play the selected chapter or play from the selected time.
2. In the state of VCD/MP3/WMA/CD disc playing, press the SEARCH button to display a interface and highlight the track item, then use the number buttons to input the serial number of the track; you can still use the direction buttons to highlight the time item, then use the number buttons to input the desired time to start playback; finally press the OK or PLAY button to play the selected track or play from the selected time.

4.14 Playback in Random

In the state of DVD/VCD(PBC OFF)/MP3/WMA/CD disc playing, press the RDM button to switch between RANDOM (ON)/RANDOM OFF. When in RANDOM (ON) mode, it will play in random.

4.15 Playback in Different Angle

1. In the state of VCD/MP3/WMA/CD disc playing, the ANGLE button on the IR remote controller is not available.
2. In the state of DVD disc playing, press the ANGLE button repeatedly on the IR remote controller to view in different angle.(This function is only for the DVD discs with ANGLE function)

4.16 Playback in Zoom Mode

In DVD/VCD mode, during playback, press the ZOOM button continuously to enlarge a certain area of the images on the screen with these multiples:

3. Radio Operation

1. BAND BUTTON

In RADIO mode, press the BAND button on the remote control or on the front panel to select your desired radio band of FM1, FM2, FM3, AM1 and AM2, and the selected band will be displayed on the small monitor of the front panel.



RADIO interface

2. TUNE/SEEK UP/DOWN BUTTONS

In RADIO mode:

- 1) Press and hold the UP/DN button to automatically search up/down for a available station from the current frequency.
- 2) Briefly press the UP/DN button to manually search up or down with step by step for your desired station from the current frequency.



AUDIO & VIDEO SETUP interface

3. APS BUTTON

In RADIO mode:

- 1) When pressing and holding the APS button, the radio searches from the lowest frequency and checks the signal strength level until 1 cycle search is finished. And then the 6 strongest stations are preset to the corresponding preset number memory bank. The APS operation is implemented in each bank of the selected band. When the APS operation is finished, the radio executes the preset scan, and after preset scanning for one cycle, it will stop scanning and broadcasting the No.1 station for FM1.(It can store 3x6 stations for FM and 2x6 stations for AM in all)
- 2) When briefly pressing the APS button on the front panel or the remote control, the radio searches for each preset station from the M1. When the field strength level is more than the threshold level of the stop level, the radio holds at that preset number for few seconds with releasing mute, and then searches again. After finishing a circle of searching, it will stop searching on the M1.

NOTE: In FM band, FM1,FM2,FM3 is checked one at a time.

In AM band, AM1, AM2 is checked one at a time.

4. PRESET STATION [1-6] BUTTONS

- 1) To memorize the current frequency on the current band, press and hold any one of the six Number buttons (1-6) .
- 2) To recall the memory station on the current band, press one of the Number buttons [1-6] .

5. STEREO/MONO BUTTON

Press the ST button on the remote control to select the STEREO or MONO sound mode for FM band.

6. LOC BUTTON

- 1) When the signal of the distance radio station are very weak and the receiving effect is bad during tuning, check whether there is the word LOC on LCD. If there is the word LOC on LCD, press this button to turn off the LOC function, then tune again for the distance radio station;
- 2) When the signals from the local radio stations are too strong, this could lead to interference. press this button to turn on the LOC function, and the LOC icon will be lit up on the LCD. Re-tune for the local station required.

7. PTY (PROGRAM TYPE) BUTTON

Press the PTY button shortly to select one of the following mode:

PTY MUSIC group- - PTY SPEECH group- - PTY OFF

When PTY group is on, press the VOL+ or VOL- button on the remote controller or rotate the VOL knob on the front panel to select one of PTY programs: <-->NEWS<-->AFFAIRS<-->INFO<-->SPORT<-->EDUCATE<-->DRAMA<-->CULTURE<-->SCIENCE<-->VARIED<-->WEATHER<-->FINANCE<-->CHILDREN<-->SOCIAL<-->RELIGION<-->PHONE IN<-->TRAVEL<-->LEISURE<-->DOCUMENT<-->PTY NONE<-->POP M<-->ROCK M<-->EASY M<-->LIGHT M<-->CLASSICS<-->OTHER M<-->JAZZ<-->COUNTRY<-->NATION M<-->OLDIES<-->FOLK M<-->

When PTY group is on, pressing the 6 number buttons also can select one of PTY programs as above.

After selecting one of the PTY programs, it will display PTY SEEK and automatically search for the station of the PTY program. If the station of the PTY program does not exist, it will display PTY NONE and then return back to the normal station.

8. AF [ALTERNATIVE FREQUENCIES] BUTTON

When pressed the AF button short, the AF switching mode is selected and the state of the AF switching mode is displayed by AF segment in display.

Segment off: AF switching mode off.

Segment on: AF switching mode on, and has RDS information.

Segment flashing: AF switching mode on, but RDS information is not received yet.

When the AF switching mode is selected, the radio checks the signal strength of the AF all the time. The interval of checking time of each AFs depends on the signal strength of the current station, from a few minute for the strong station to a few seconds for the weak station. Every time that a new AF is stronger than the current station, it switches over to that frequency for very short time, and the NEW FREQUENCY is displayed for 1-2 second. Because the mute time of the AF switching or the checking time is very short, it is almost inaudible in case of normal program. (When AF flash on LCD, it will search for the stronger RDS station. If AF and TP flash on LCD, it can only search for the traffic announcement station).

In FM mode, when AF is on, SEEK, (SCAN), AUTO-MEMORY function can only receive and save the RDS program.

9. TA [TRAFFIC ANNOUNCEMENT] BUTTON

Press the TA button shortly to turn on TA search mode.

When traffic announcement is transmitted:

- 1). If the unit is in Disc Play mode, it will switch to radio mode temporarily.
- 2). Temporarily switch over to an EON linked station when EON detects a traffic announcement on that other program, and TA, TP will be displayed on LCD

* TA interruption function:

The current traffic announcement is cancelled by pressing TA button shortly.

* When TA is on, SEEK, (SCAN), AUTO MEMORY function can be received or saved only when traffic program identification code has been received.

During slow forward, press the PLAY button to resume normal playback.

The function is only for video.

4.10 Playback with still frame

If the unit is currently running DVD/VCD disc, press the STEP button consecutively to display the still frame forward with step by step.

Press the PLAY button to resume normal playback.

4.11 Playback Repeatedly

4.11.1 ONE/ALL Repeat

1. In the mode of DVD disc playback:
Press the RPT button to select REP CHAPTER, REP TITLE, REP ALL or REP CANCEL
2. In the mode of VCD(PBC OFF)/CD disc playback:
press the RPT button to select REP 1, REP ALL or CANCEL.
When it is in the state of PBC ON, during VCD disc playing, the RPT button are not available.
3. In the mode of MP3/WMA disc playback:
Press the RPT button to select REP 1, REP DIR, REP ALL or CANCEL.

4.11.2 A-B Repeat

Press the **A-B** button if you want to repeat a specific segment on a disc that you define:

1. Press the **A-B** button at a point (A) where you want it to be the start point of the repeat segment. Press the **A-B** button again at a point (B) where you want it to be the terminal point of the repeat segment. Then it will play the segment repeatedly.
2. To cancel the A-B repeat mode and resume normal playback, press the **A-B** button for the third time.

Note:

During VCD/MP3/WMA/CD playback, points A and B must be within the same track.

During DVD playback, points A and B can be selected from different chapters.

In VCD mode

1. When starting to turn on the PBC function, it will play from the beginning of the disc till it display the PBC menu on TV screen if the disc include the PBC menu.
2. Press the number buttons to select your desired track to play.

In MP3/WMA mode

1. The root menu is displayed on the monitor screen all the time (and the TITLE or MENU button is not available).
2. Press the direction buttons to select your desired FOLDER, then press the OK or PLAY button to open the FOLDER, and then press the direction buttons to select your desired file, finally press the OK button to play the selected file.

In CD mode, the TITLE, PBC, MENU buttons are disabled.

4.7 Terminate the Playback

1. Press the RELEASE button to detach the front panel from the unit, then press the EJECT button to eject disc, and then remove the disc and flip up the front panel till hearing a clip.
2. Long press the POWER button on the front panel or briefly press the POWER button on the remote controller to turn off the DVD player.

4.8 Playback with Speed

During normal playback, long press the UP/DN button on the front panel or the >>|/|<< button on the remote controller continuously to fast forwards or backwards at the following speeds: x2, x4, x8, x20, normal.

During speed playback, press the PLAY button to resume normal playback.

4.9 Playback with Slow Speed

During playback, press the SLOW_FWD button to execute the Slow Forward function.

With each consecutive pressing of the SLOW_FWD button, the playback speed decreases. The speed levels in Slow Forward as follows: x1/2, x1/3, x1/4, x1/5, x1/6, x1/7, normal.

4. Basic Disc, USB or MMC/SD Operation

4.1 Begin playback

1. Press the POWER button briefly to turn on the DVD player.

After turning on the DVD player, please turn on the monitor, and ensure that the video output of the monitor is the video input from the DVD player connected with the monitor.

? Common Question

Q: There is not anything is displayed on TV screen when the DVD player is turned on. How to solve the problem?

A: Ensure that the TV was set to right video input (not TV channel); for example, if you make VIDEO1 INPUT of TV and DVD player connected with each other, then you need set TV to VIDEO1.

2. Press the RELEASE button to detach the front panel from the unit.

3. Insert a disc into the DISC SLOT (Label surface up), then flip up the front panel till hearing a clip.

NOTE

1. For some discs that are seriously scratched or poor manufacturing or recording quality, it may not play.

2. If the player can not read disc under normal condition, please try to eject and reload the disc again.

3. Remark:

1) In addition to normal CD and DVD, this unit supports to play CD-R, CD-R/W, DVD-R and DVD-R/W as well; however, depending on the conditions of the recording equipment, recording program or the disc itself, some CD-R, CD-R/W, DVD-R or DVD-R/W may not play.

2) When dealing with CD-R, CD-R/W, DVD-R or DVD-R/W recording, too high recording speed may result in poor signal quality and therefore, it is recommendable to select as lower as possible recording speed.

4. Play USB & Card

Insert an USB or MMC/SD Card into their slots respectively, then the root menu will be displayed on the monitor and it will play audio file automatically if the USB or MMC/SD Card include audio files.

Press and hold BAND to turn on SHIFT.

 : select to pause playback.

 : select to stop playback .

 :select one of them can switch on between the speed levels of fast backward or forward. (Except image mode.)

 : select one of them can select next or previous chapter/track.

 : select to turn volume up and down.

 : select to turn the selecting page up and down.

 : select to RDM play mode as the remote control. (Only for music mode.)

 : To select audio language.

 : Same as the PRG button on the remote control.

 : Same as the A-B button on the remote control.

 : Same as the REPEAT button on the remote control.

 : Same as the SUBTITLE button on the remote control.

 : To select the track/chapter from 1-9 and then select OK to play your selecting.

 : During playback, press the ZOOM button and then tap one of them are same as the direction buttons on the Remote Control. (Except music & image mode.);During playback, press one of them to change the playback angle. (Only for image mode.)

 : Same as the ZOOM button on the remote control.

 : Select to play step by step, select >II to turn to normal play.

 : To select the track/chapter from 0-9 and then select OK to play your selecting.



Interface for MUSIC



Keyboard interface-1



Keyboard interface-2



Keyboard interface-3

4.2 Pause Playback

In the state of DVD/VCD/CD/MP3/WMA disc playing, press the PAUSE button on IR remote controller to pause the playback, press the PLAY button to resume normal playback.

4.3 Stop Playback

In the state of DVD/VCD/MP3/WMA/CD disc playing, press the STOP button once to pause the playback, then press the PLAY button to resume the normal playback; press the STOP button twice to full stop the playback, then press the PLAY button to start playback from the beginning of the first chapter/track.

4.4 Select Chapter/Track with the UP/DN or the >>|/|<< Button

Press the UP/DN button on the front panel or the >>|/|<< button on the remote controller during playback to select the next or last chapter/track to playback.

Note: Press the UP/DN or the >>|/|<< button multiple times to advance multiple chapters/tracks forward or backward.

4.5 Select Chapter/Track with the Number Buttons

In the state of DVD/VCD(PBC OFF)/MP3/WMA/CD disc playing, press one of the 1~9 and the 0/10 number buttons to directly select and play the 1st to 10th track/chapter (the 0/10 button is used as the 10 button).

If you want to play the track/chapter that's serial number is bigger than 10, use the 10+, 1~9 and 0/10 button. For example 1, to play the 13th track/chapter, firstly press the 10+ button once, then press the 3 button. For example 2, to play the 34th track/chapter, firstly press the 10+ button for 3 times, then press the 4 button. (the 0/10 button is used as the 0 button)

Note: long pressing the +10 or -10 button can play the next 10 or last 10 chapter/track (only for MP3/WMA).

4.6 Select Chapter/Track with the Root/PBC Menu (If the disc includes the root/PBC menu)

In the state of DVD disc playing

1. Press the TITLE button on the remote controller to display the title list.
2. Press the direction buttons to select your desired title, and then press the OK or PLAY button to open the root menu of the selected title.
3. Press the direction buttons to select your desired chapter, finally press the OK or PLAY button to play the selected chapter.

During playback, pressing the MENU button can directly display the root menu of the title that is playing.