

WTT
WESTINTRENDS
WTT
DESIGNED IN CALIFORNIA

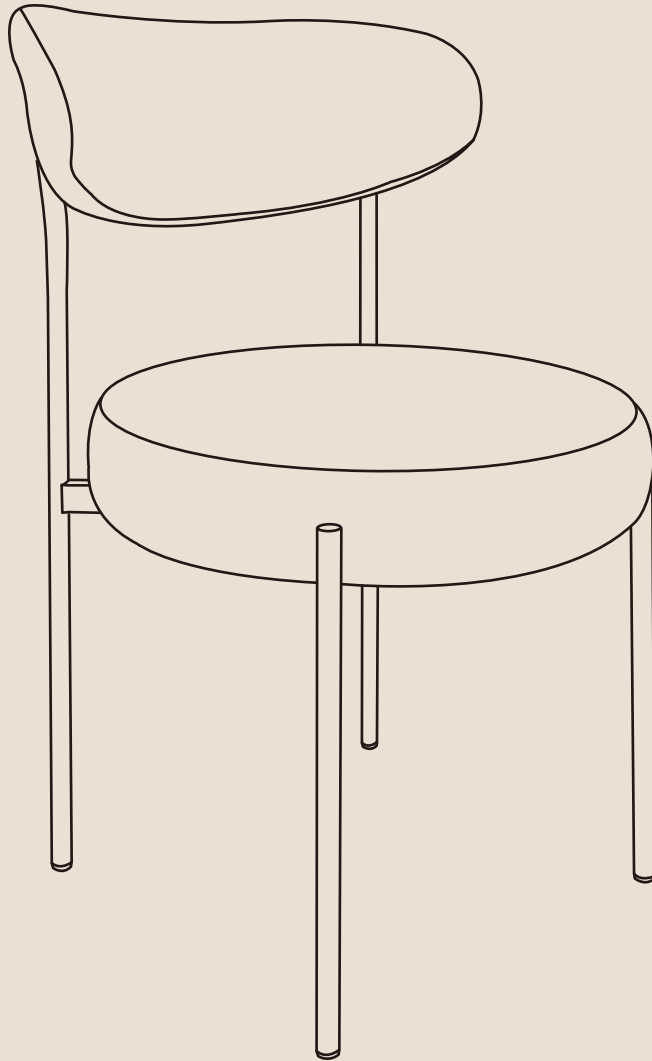

SIDE CHAIR

V1.0

THANK YOU!

We appreciate you for choosing WestinTrends!

Thank you for letting WestinTrends continue to offer accessible luxury trends, inspired by everyone!

JOIN THE WESTINTRENDS COMMUNITY

Sign up here:

[**https://westintrends.com/welcome**](https://westintrends.com/welcome)



QUESTIONS OR COMMENTS?

If you have questions reach out to

[**cs@westintrends.com**](mailto:cs@westintrends.com)

FOLLOW, SHARE, & LEARN



PRODUCT REGISTRATION

[**https://westintrends.com/apps/product-registration**](https://westintrends.com/apps/product-registration)



ACCESSIBILITY - COMMUNITY - VALUE - SUSTAINABILITY

! CARE&MAINTENANCE

- Be careful when assembly, avoid hurting the plating of the surface.
- Clean the chair with lukewarm water, mild detergent & soft cloth.
- Firmly secure all bolts before use, do not use any part of this item as a step ladder.
- Reconfirm that all bolts, screws, and nuts are secure every 90 days.
- Do not use or store this item in the proximity of open flame or flammable/combustible chemicals.
- Be aware that some parts are heavy and have sharp edges.
- Do not overtighten screws. (Insert all screws before tighten screws.)

TOOLS REQUIRED



250 LBS
CAPACITY







1 PERSON
ASSEMBLY







UP TO 15 MIN.
ASSEMBLY

HARDWARE

1 SHORT BOLT M6 x 30mm  1 PCS	2 LONG BOLT M6 x 45mm  4 PCS	3 FLAT BOLT M6 x 30mm  2 PCS	4 ALLEN WRENCH M6 x 140mm  1 PCS	P2 FELT PAD Φ 15mm  4 PCS
--	---	---	---	--

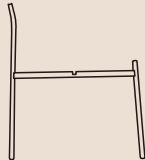
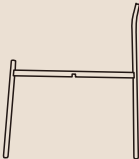
PARTS

A BACKREST  zipper side down 1 PC	B CUSHION SEAT  1 PC
C LEFT BACK LEG with adjustable feet leveler  1 PC	D RIGHT BACK LEG with adjustable feet leveler  1 PC

adjustable feet leveler 

PRODUCT ASSEMBLY - OVERALL VIEW

Look at following overall view of this chair and learn the exact position of each parts to be assembled.

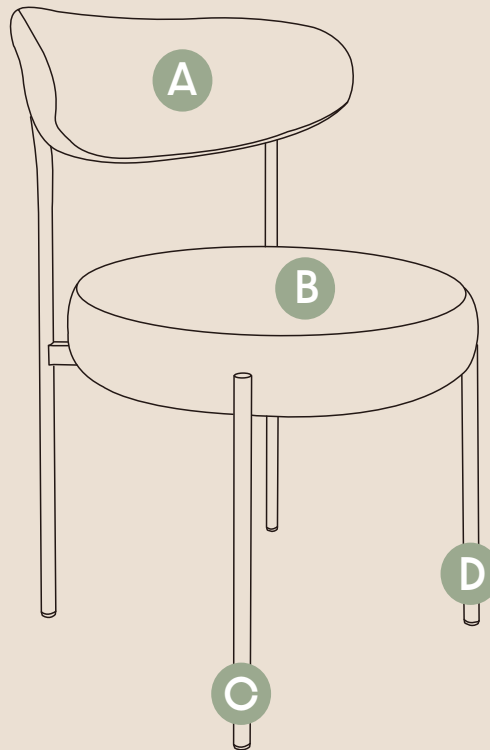

PRODUCT ASSEMBLY

- 1 Put 1 piece of **Part C Left Back Leg** & 1 piece of **Part D Right Back Leg** exactly as show below. Attach them with 1 piece of hardware **#1 Short Bolt** through the middle screw hole (80% tighten).

PAY ATTENTION: Each leg is with an arrow on front side. Make sure two arrows point to **FRONT INTERIOR** after assembly.

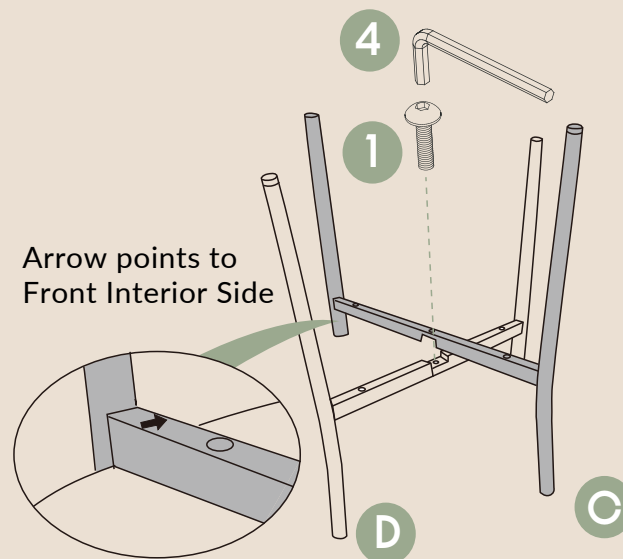

2

Put **Part B Cushion Seat** up side down on a clean table.
Attach **Part C & D** on bottom of **Part B** with 4 pieces of hardware **#2 Long Bolt**.

PAY ATTENTION: **Part B Cushion Seat** has a FRONT side sticker.
Make sure the direction is correct before screwing.

80% tighten all the five bolts on bottom of the cushion seat.

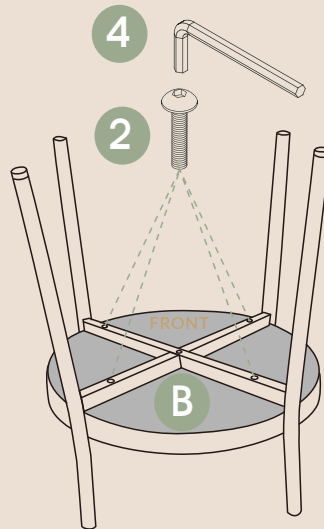

3

Attach **Part A Backrest** onto top hole of **Part C & D Back Legs** with 2 pieces of **#3 Flat Bolt**.
80% tighten.

Place the chair in normal position, press downward and adjust the legs to be straight.
Then tighten all 7 screws to 100%. Adjust the feet leveler on four legs for best balance.

Stick 4 pieces of **P2 FELT PAD** onto the bottom of feet for better protection of the floor.

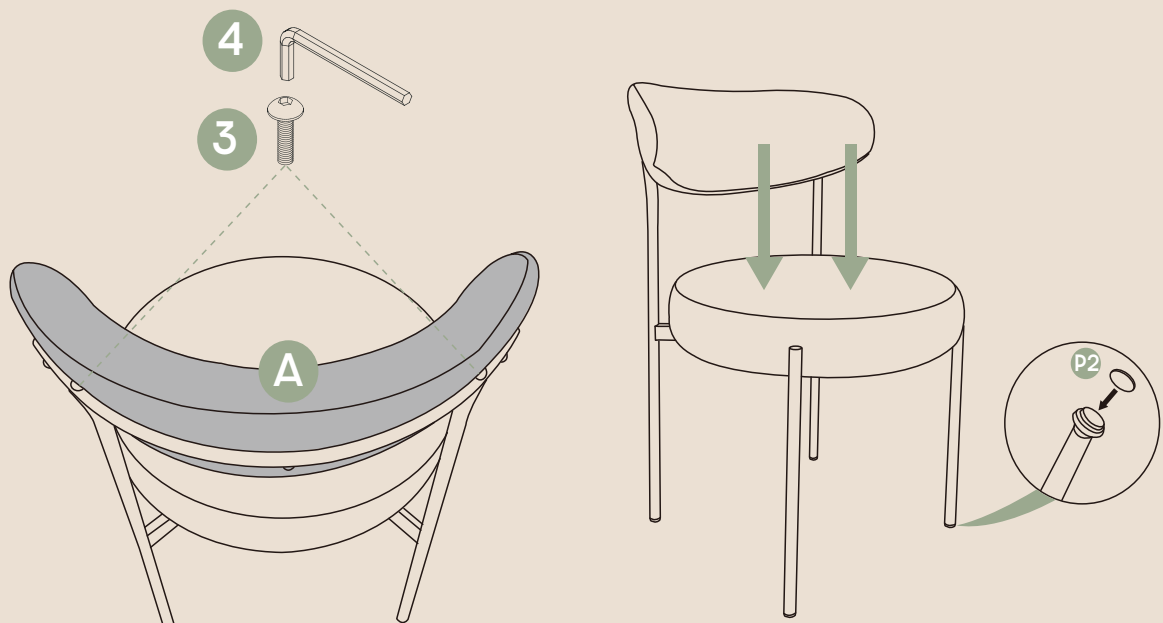

REGISTRATION & REFUND POLICY

<https://westintrends.com/apps/product-registration>



<https://westintrends.com/policies/refund-policy>



HAVING TROUBLE

- **Not sure how to assemble or missing pieces?**

Please contact our Customer Service Team for assistance at cs@westintrends.com

Have Order #, Part # or SKU ready to speed up customer service!

CLEANING TIPS

REGULAR CLEAN: Dust periodically with lukewarm water, mild detergent & a soft clean dust cloth. Avoid the use of chemicals as they may damage the finish.

QUICK CLEAN: For spots or smudges on the upholstery fabric, highly recommend immediate clean. Lightly moisten a cloth with water and wipe clean.

Regular cleaning not only preserves the aesthetic appeal of your furniture but also helps extend its lifespan.