

# USER'S MANUAL

## BV9979B

### BLUETOOTH®

### DVD/MP3/CD AM/FM RECEIVER

FEATURING MOTORIZED 7" (178mm) WIDESCREEN TOUCHSCREEN  
DIGITAL TFT LCD MONITOR



# BOSS®

AUDIO SYSTEMS

**To ensure safety while driving**

**and to comply with laws,**

**drivers should not watch video or**

**operate the video device while driving.**

## CONTENTS

General Information.....	1
Safety Notice.....	2
Accessories.....	3
Remote Control Operation.....	4
Unit Installation.....	6
Wires Connection Description.....	7
Panel Introduction.....	8
Main Menu Operation Instruction.....	9
Access Setup Interface.....	9
Clock Setup.....	11
General Setup.....	11
Audio Setup.....	12
Disc Setup.....	13
Other Setup.....	14
SWC-Steering Wheel Control Setting.....	14
Radio Operation.....	15
DISC/CD/USB/SD Playback.....	17
Media.....	18
USB/SD Menu.....	19
Bluetooth Operation.....	20
Bluetooth Operation Menu.....	20
Bluetooth Dialing.....	21
Bluetooth Call.....	21
Bluetooth Phone Book.....	22
Bluetooth Phone Call History.....	23
Bluetooth Music Streaming-A2DP.....	23
Photo.....	24
Camera/Aux/AV Menu.....	25
Troubleshooting.....	26

# SPECIFICATIONS

Model No.	BV9979B		
General features	Fixed front panel 7 inch TFT screen FM/AM Radio RDS DVD fully compatible with DVD/VCD/CD/MP3/MPEG4/JPEG Front & rear USB reader support SD card reader support Built-in Bluetooth AUX Input AV Input AV output Rear view camera Front, Rear and Subwoofer Pre-Amp Output 85W*4 AMP power output maximum Steering wheel control		
TFT screen	800*480pixel		
SD	32G		
Working power	12 V		
Max Output	85W*4		
Working Temperature	-20°C~70°C / -4°F~158°F		
Size	178*50*160mm		
Weight	1.92kg / 4.23lbs		
Compatible Media			
Picture	JPG/JPEG/BMP		
Disc	CD/CD-R/CD-RW/DVD/DVD±R/DVD±RW		
Audio file	MP3/AAC/WAV		
Video file	.AVI	MP3	MPEG-4
	MP4	AAC	MPEG-4 Visual
	MPG	AC-3	MPEG-1/2

## SAFTY NOTICE

---

Please read and understand the following safety information before operating this unit.

⊘ The device is suitable for 12V power supply (requires grounding). Do not connect it to 24V power supply in trucks or buses, or else it will be damaged.

❗ Please use genuine discs, instead of incompatible and poor discs, or else it will damage the device or shorten the service life.

❗ Without the guide of qualified personnel, do not replace the fuse, or else it may damage the device or cause fire.

⚠ Please follow the traffic laws and regulations and do not watch program or operate the device when you are driving, to avoid accidents (excluding passengers watching through rear monitor).

❗ To ensure safety and operate the device normally, please ask qualified personnel to install the device. do not disassemble or repair the device without authorization, to avoid damage and accidents.

Please contact local car audio distributor for details.

⊘ Do not put the device in moist environment or water, to avoid electric shock, damage and fire due to short circuit.

⊘ The mechanical drive part of the monitor uses automatic precision transmission component. Do not pull, push or rotate the device by force or impact the TFT screen to avoid damaging the device.

❗ Do not insert the audio plug of the vehicle into the master unit directly. please convert with the dedicated end cable provided by our company.

❗ When install the unit, prevent metal objects falling into the master unit from the vents to avoid short circuit and damaging the device.

### Safety Statement

⊘ For the safety of you and others, do not watch programs or operate the device when you are driving. It is prohibited by the laws and regulations.

❗ The backing monitor function should be used as auxiliary means. we are not responsible for any accidents occurred during backing.

# ACCESSORIES

Below are the photos with the accessories included in the box.

Remote Control



Cable



Mounting Strap/Release Key /Mounting Sleeve

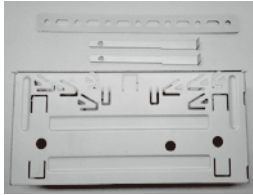

Mounting Hardware



Screw  
PM4\*5mm 4pcs



Flat gasket  
M5Φ10X1.0mm  
2pcs



Hex nut  
8.0 mmΦ5.0X1.0mm  
1pc

Trim Ring/Touch Pen



Screw  
PA5\*18mm 1pc



Spring Washer  
1pc



Rear Chassis  
Support Bolt  
M5x23mm 1pc



Rubber Support  
Boot 1pc

# REMOTE CONTROL OPERATION

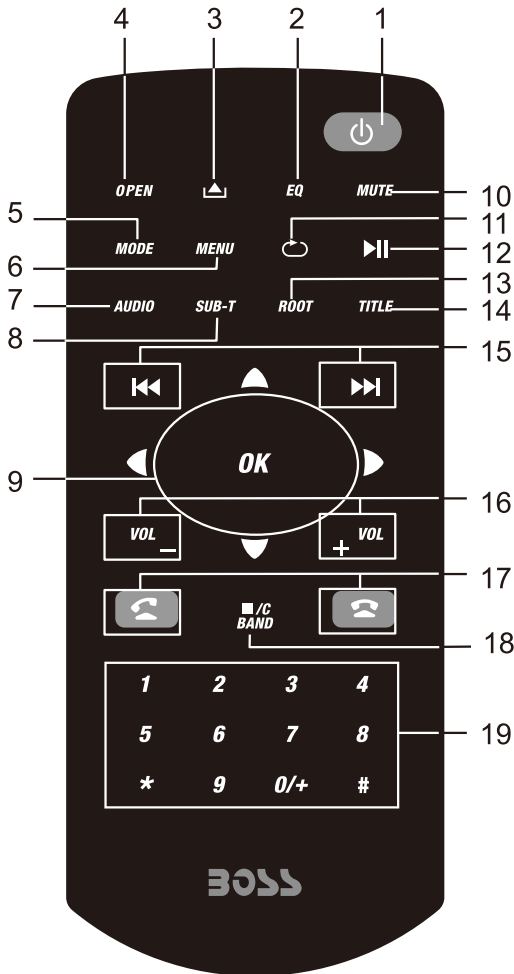

## 1. PWR ON/OFF

Press to turn on or turn off the unit.

## 2. EQ mode

Press to set EQ mode.

## 3. EJECT Key

Press to eject the Disc in the unit. And press again to load the Disc if you do not take out it.

## 4. OPEN key

Press to make the screen stretching out or go back.

## 5. MODE key

Press to change mode of the unit.

## REMOTE CONTROL OPERATION

---

### **6.MENU key**

Press Menu to return to the home menu.

### **7.Audio KEY**

Press to change switch language in DVD mode, and switch left, right or stereo in VCD mode.

### **8.SUBTITLE Changing Key**

Switch the subtitle during playing if the Disc have multiple subtitle.

### **9.Direction and OK key**

If there is a Disc with root list menu,press direction key to move up/down/left/right, and press OK to confirm.

### **10.MUTE key**

Short press to mute the unit. Long press to make panel go dark, and press any empty place, will run the unit.

### **11.REPEAT key**

Under DISC/SD/USB mode, press to set the repeat mode.

### **12.Play/Pause**

Press to switch play pause.

### **13.ROOT key**

DVD playing mode, press to go into root list menu; VCD playing mode, press to turn on/off PBC function.

### **14.TITLE key**

Under DVD playing mode, press to enter into title list menu.

### **15.Under Disc/ SD/USB mode, press to choose previous/next song.**

Under music list menu, press to choose PRE/NEXT page. Under RADIO mode, press to search frequency forward/backward.

### **16.VOLUME UP/DOWN key**

Press to adjust volume up and volume down.

### **17.Receiving calls/call out; hang up.**

### **18.STOP/C/BAND**

In disc playing mode, press to STOP, press “ok” to start;

In radio mode press to change band between FM1/FM2/FM3/AM1/AM2; Press to enter RADIO mode, except DVD mode.

Delete wrong number when in phone mode.

### **19.Number key**

Enter phone number in phone mode.



# UNIT INSTALLATION

THE UNIT IS INSTALLED TO BE AN ANTI-THEFT ONE. THE CHASSIS OF THE UNIT WEARS A SLIDING METAL HOUSING. PLEASE DO THE CONNECTION OF THE POWER, SPEAKERS AND ANTENNA ACCORDING TO THE REQUIREMENT OF THE INSTRUCTION BOOK , THEN INSTALL THE SLIDING METAL HOUSING IN THE CAR AS FOLLOWS.

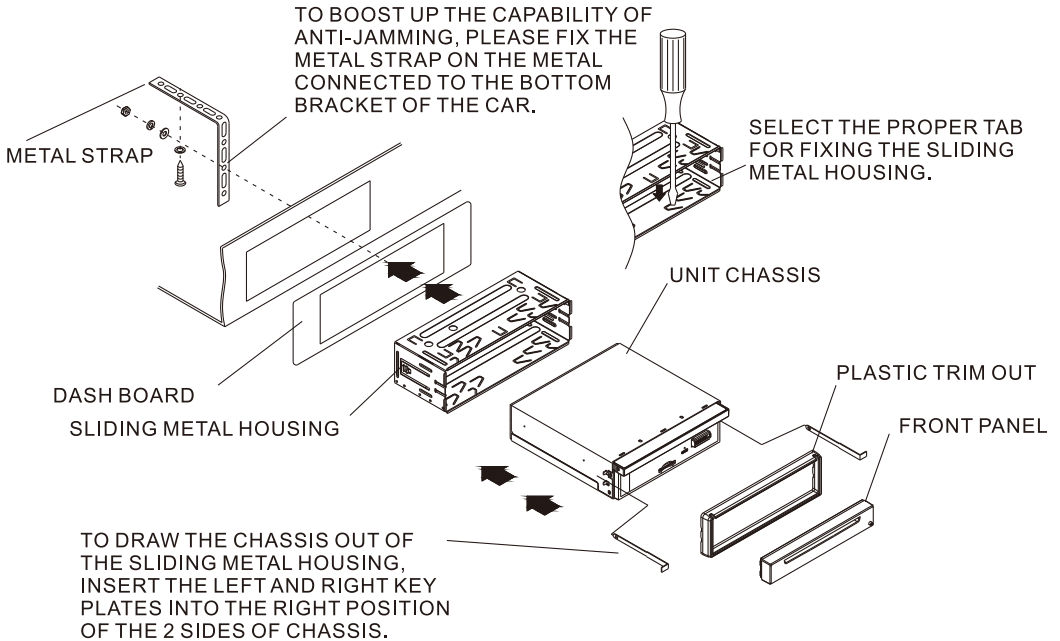

# WIRES CONNECTION DESCRIPTION

## The Description of the Input/Output Interface of the Rear Cabinet

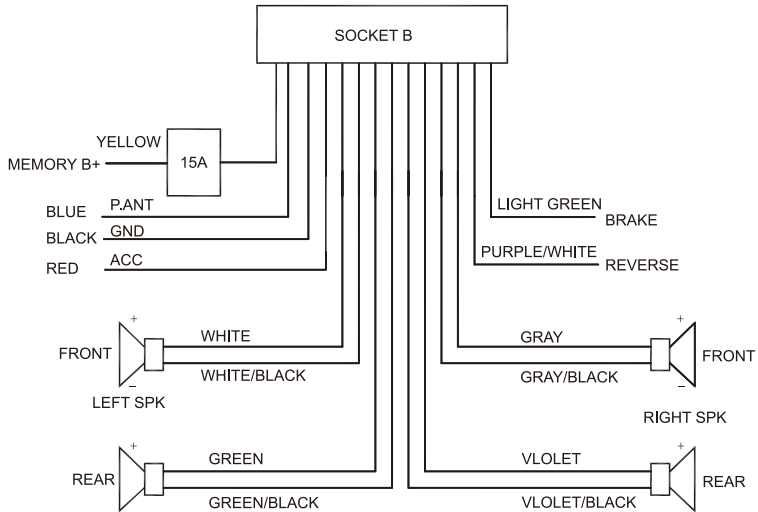
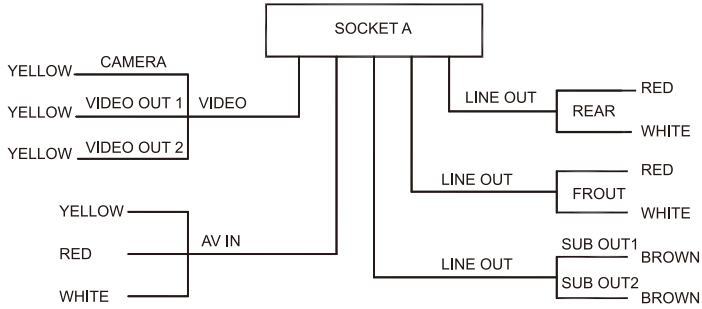
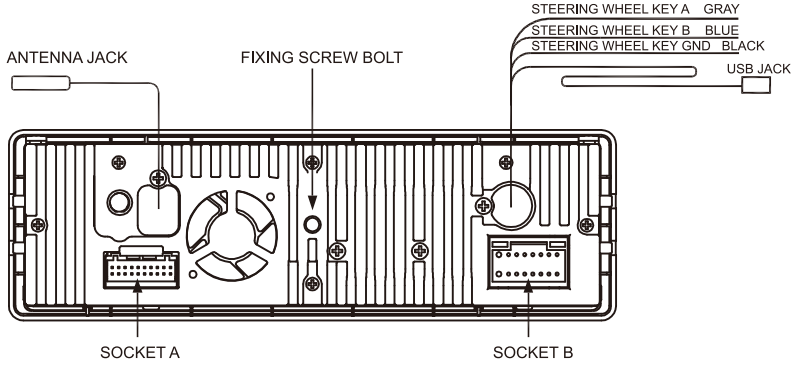

# PANEL INTRODUCTION

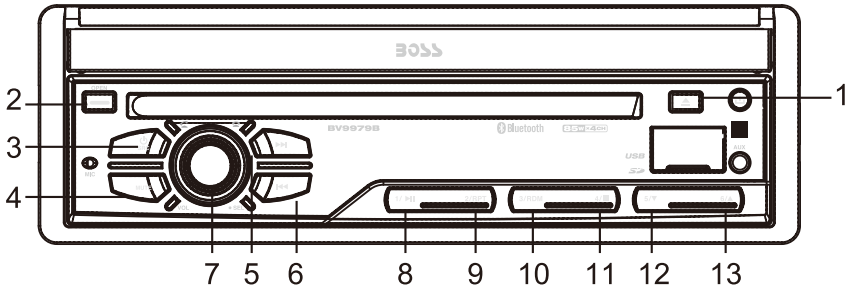

## 1.Eject key

When there is a Disc in the unit, press EJECT to remove the Disc. And press again to load the Disc if you do not take it out.

2.Short press to power ON the unit, and open/close the screen. Long press to power OFF the unit.

## 3.SOURCE key & PWR ON/OFF

Short press to select system mode(RADIO/DISC/PHONE/STREAMING/AUX/USB-F/USB-R/SD/AV IN/CAMERA). Long press to turn ON/OFF the unit.

## 4.MUTE key

Press to activate the MUTE function and silence the audio output. Press again to restore sound.Long press to turn off the backlight; then press any place of the TFT LCD to restore the backlight.

## 5/6. ◀◀ & ▶▶ button

Press to choose previous/next song under Disc/SD/USB mode.  
Press to choose previous/next page under music list menu.  
Press to search frequency forward/backward under radio mode.

## 7.VOLUME UP/DOWN & Talking Calls & HANG UP

Rotate to adjust the output volume UP or DOWN.  
Press the volume button to take incoming calls under Bluetooth mode;  
Press the volume button to hang up the phone calls during phone calls.  
Long press to reject incoming calls.  
If there root list menu of DVD, MP3 mode, press direction key to move up/down/left/right, and press volume button to confirm enter.

## 8/9. Choose frequency1/2 in radio mode.

Play/Pause/Repeat in video/audio mode.

## 10/11. Choose frequency3/4 in radio mode.

Random playing/ Stop in DVD/USB/SD mode.

## 12/13. Choose frequency5/6 in radio mode.

Press to adjust screen angle.

# MAIN MENU OPERATION INSTRUCTION

## MAIN MENU 1



## MAIN MENU 2



## MAIN MENU 3

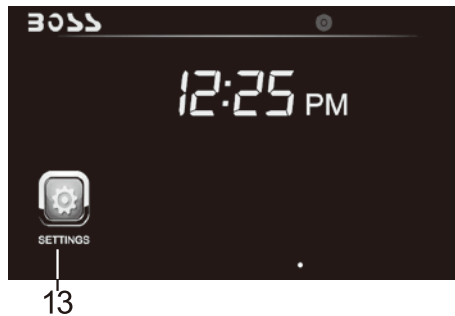

1. Shows the present time of the unit.
2. Press to go into main menu 2.
3. Radio Interface

### 4. Disc Interface

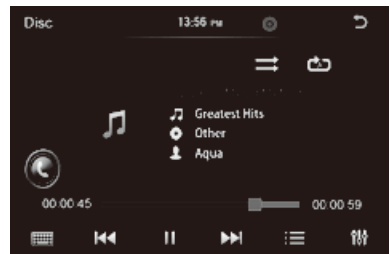

# MAIN MENU OPERATION INSTRUCTION

## 5 . Phone setup Interface

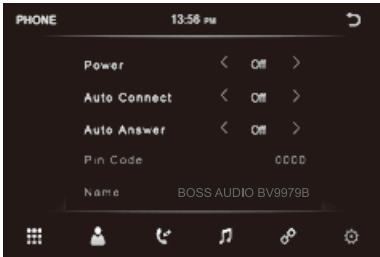

## 6.Streaming

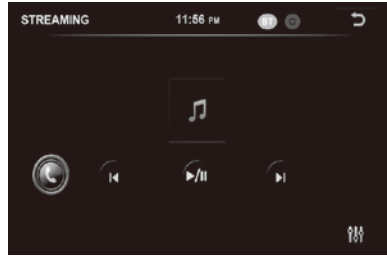

## 7.AUX IN Interface

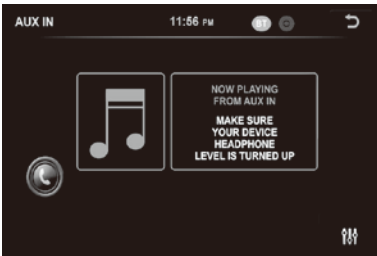

## 8.9. USB Interface

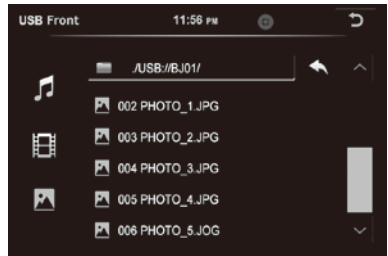

## 10.SD Interface

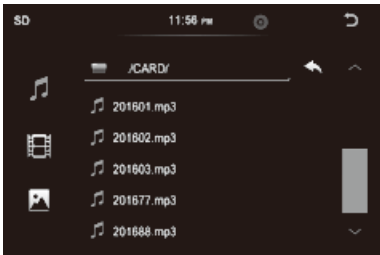

## 11 . AV Interface

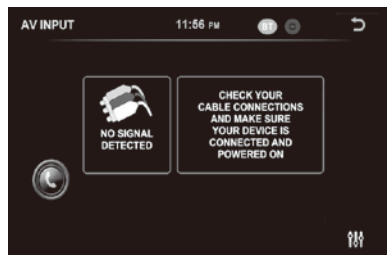

## 12.CAMERA Interface

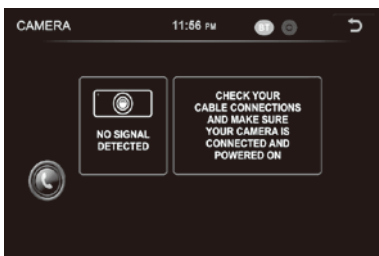

## 13. Settings Interface

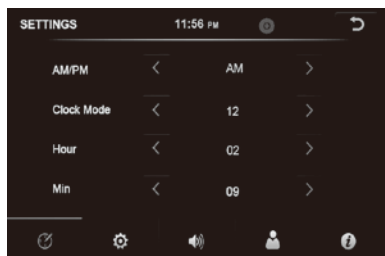

# ACCESS SETUP INTERFACE

There are five menu in setup:

## CLOCK SETUP-Menu 1

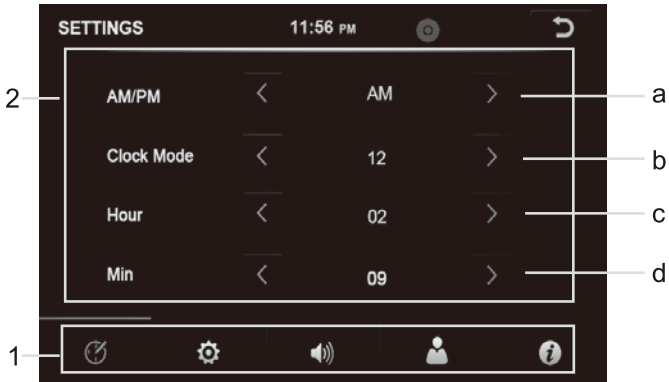

1. Setup function area: Clock setup, General setup, Audio setup, Disc setup, Other setup.
2. Subsidiary function area: Move up and down to see the general setup items.
  - a. Press to set AM/PM at 12hr mode.
  - b. Press to set clock mode: 24/12 hr.
  - c. Press to set hour.
  - d. Press to set minute.

## GENERAL SETUP-Menu 2

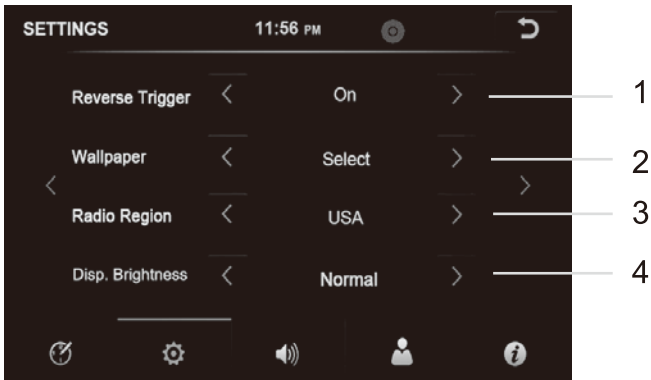

# ACCESS SETUP INTERFACE

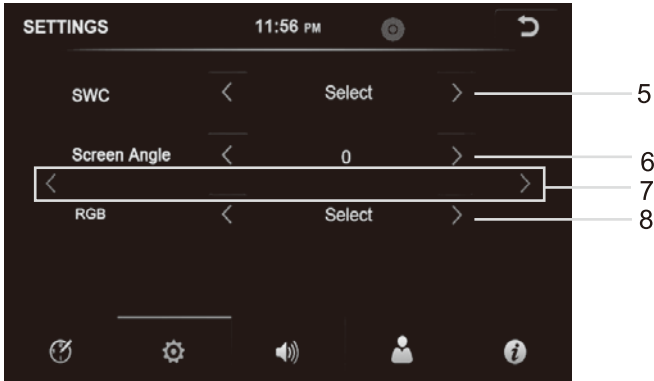

1. Reverse trigger: Turn on if you have a rear view camera. Turn off if you haven't.
2. Touch to set wallpaper
3. Touch to choose radio field between: USA/Europe /Latin 1 /Latin2/ORIT.
4. Backlight dimmer selection: Night /Dark /Normal/Bright.
- 5.Touch to enter SWC menu.
6. Screen Angle: select an optimal angle of the monitor.
- 7.Sliding Left or right to enter into some other setup subsidiary functions.
- 8.Touch to enter into RGB SETUP menu

## AUDIO SETUP-Menu 3

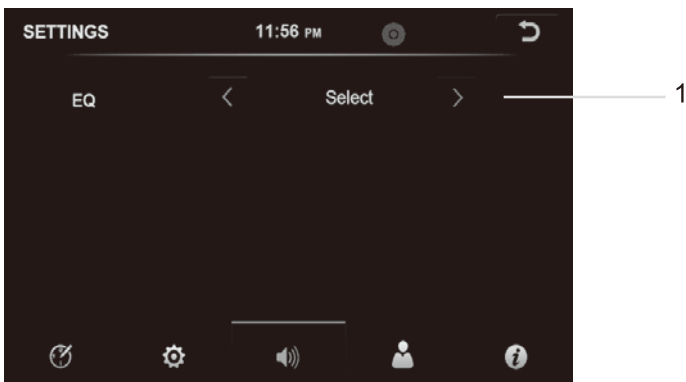

# ACCESS SETUP INTERFACE

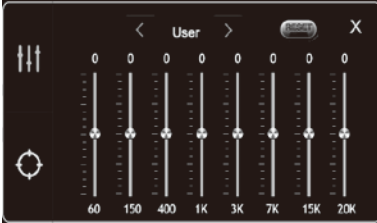

1. Press to enter into EQ set up menu.

## DISC SETUP-Menu 4

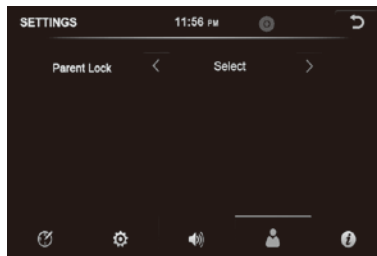

1.Touch to set up the level of the DVD. Default password is 0000



## OTHER SETUP-Menu 5

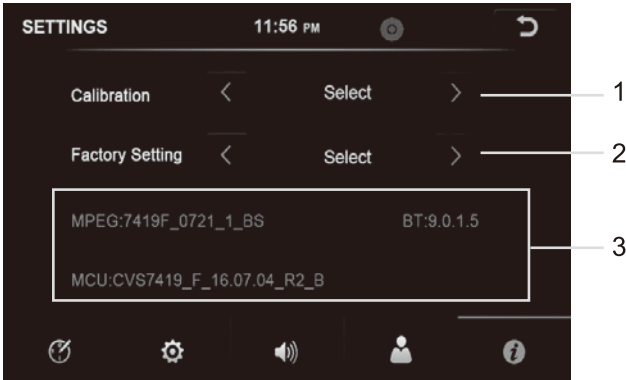

1. Touch to enter calibrate menu.
2. Load factory setting.
3. Show the software version information.

## SWC-STEERING WHEEL CONTROL SETTING

Touch SWC enter SWC setting menu :

Press "OK" to start SWC leaning.

**Start learning:**

Set the POWER button as an example.

1. Press POWER button in the unit (Picture 1), then you will see reminder like picture 2, Press OK.

2. Press POWER key in your steering wheel. Then you can see the reminder in the unit like Picture .Setting successfully. Will show like Picture 3.

3. Click OK, and finished learning.

4. Repeat 1-3 to learning other keys.

**Picture 1**

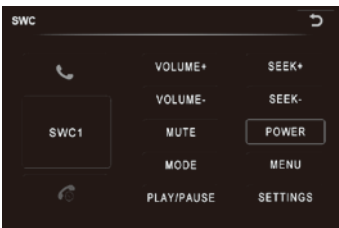

**Picture 2**



# RADIO OPERATION

Picture 3

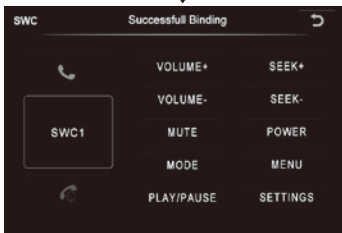

SWC1: Select different SWC resistance to meet different cars. If you cannot finish all key pairing, you can press to select SWC2 SWC3, until all keys can learn.

NOTE: Click SWC1 you will lost all KEY learning before.

## RADIO OPERATION

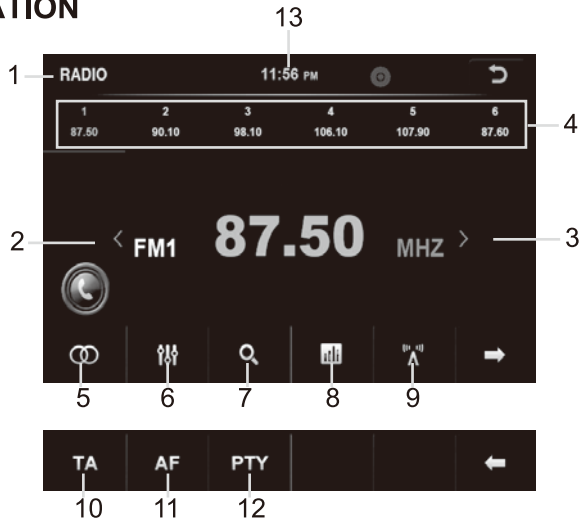

1. Show the present mode. Touch  to go back home.
2. Short press to seek backward. Long press to enter manual mode and backward in step.
3. Short press to seek forward. Long press to enter manual mode and forward in step.
4. Preset stations area, long press to save current station.
5. Stereo on/off: Click to turn on/off stereo when receiving a stereo signal.
6. Press to enter into EQ menu.
7. Short press for PS, long for AS.
8. Band changing: Click to change band between FM1/FM2/FM3/AM1/AM2.
9. LO/DX: Touch to select Local or Distant broadcasting stations.

## 10. TA(Traffic Announcement)

**ON:** When the traffic station is turned on, the radio will automatically search for traffic stations.

**OFF:** Repress [TA] button to close TA function. In other modes, traffic announcement will automatically switch to radio mode, after the traffic announcement is completed, it will automatically switch to the previous mode.

## 11 . AF(Auto Frequency)

Touch the button to turn the AF function on/off. AF function is turned on, When the received station signals become weak, the radio will automatically fine-tune to other frequencies. When receiving an emergency announcing, the screen will display warning message.

## 12 . PTY(Programming Type)

Touch the button the screen displays program types, users can search station according to program type.

13 .Press this area in any interface, you will see below present time standby mode:

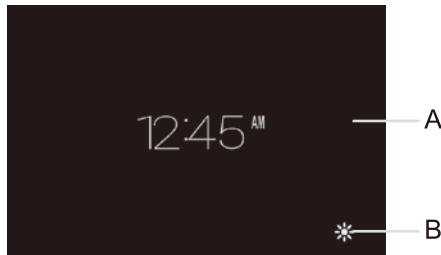

**A.**Press any empty area in this menu to go back to last source menu.



**B.**Press to dim the unit.

**Note:** If RDS is turned OFF, AF/TA/PTY will not function.

# DISC/CD/USB/SD PLAYBACK

## MEDIA PLAYING VIDEO FORM PLAYING



- 1.Touch  to select one of the three Menu Control Bars:  
2. KEYPAD: Touch to select chapter of DVD.
- 3.Short press to move to previous chapter, Long press to fast reverse.
- 4.PLAY/PAUSE: Touch to begin playback/pause.
- 5.Short press to move to next chapter, Long press to fast forward.
- 6.Touch to enter DVD Menu.
- 7.Touch to alter repeat mode in the following sequence:
  - DVD: Repeat All, Repeat OFF, Repeat Chapter, Repeat Title .
  - VCD: Repeat All, Repeat OFF, Repeat Single .
- 8.Random play.
9. Touch to setting menu of brightness and contrast.
- 10.Touch to enter DVD Title.
- 11.Touch to select the subtitle language if the disc is recorded in multiple languages.
12. Touch to switch video 4:3 and 16:9.
13. Touch to show in for mation of the video.
14. Touch to selcet DVD video angle.
15. Touch to select the audio language.

## DISC/CD/USB/SD PLAYBACK

**NOTE:** When properly installed, a video cannot be displayed unless the parking brake is applied. If the parking brake wire is not installed correctly, the following message will appear.



### MEDIA PLAYING—CD AUDIO

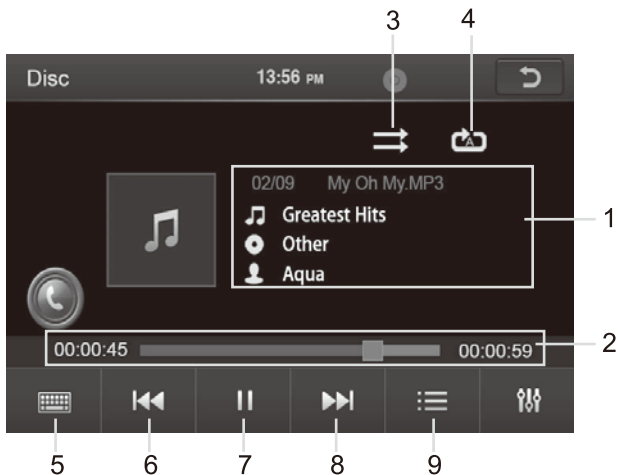

- 1.Track now playing、Playing status、The disc type.
- 2.Time bar shows total time and playing time of the present song.
- 3.Random play.
- 4.Repeat mode:Repeat the song or Repeat the disc.
5. KEYPAD: Touch to select chapter of CD.
- 6.Touch to move to previous chapter .
- 7.PLAY/PAUSE: Touch to begin playback/pause.
- 8.Touch to move to next chapter.
- 9.Touch to view the song list of the CD.

# DISC/CD/USB/SD PLAYBACK

## Source Menu of CD

Touch the SOURCE MENU(ICON 5) to access to the CD track menu to view or change tracks manually. Touch again to return to the playback of the current track.

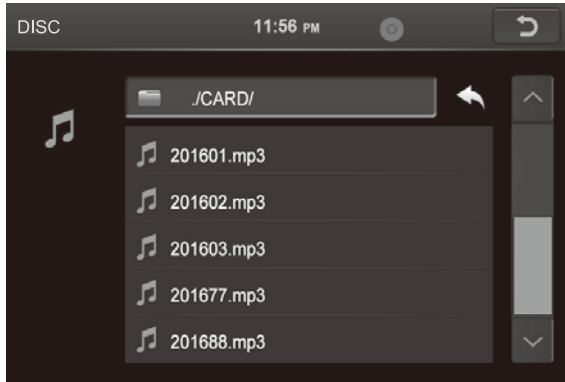

## USB/SD MUSIC/VIDEO/PICTURE

Press USB/SD in the main menu, music menu is all same with the Disc music. There is only one different: it will show more ID3 information on it such as: song name, singer.

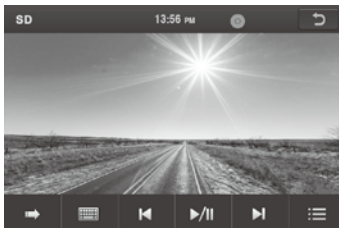
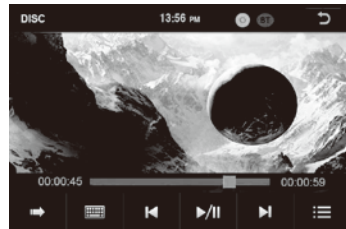
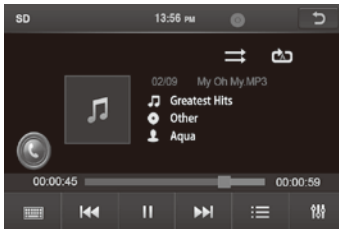

# BLUETOOTH OPERATION

## BLUETOOTH OPERATION MENU

Click phone icon and will enter into Bluetooth function interface:

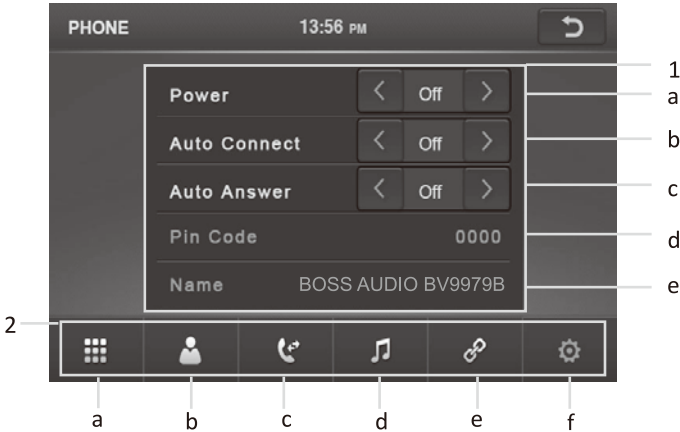

### 1. Bluetooth setting menu:

a. ON/OFF: Turn on and turn off of Bluetooth .

Turn on: show gray BT  . and the icon turn blue when paired phone.

b. Connect automatically: Can connect the devices automatically which have already been connected before .

c. Answer automatically: Can turn on or turn off the function of listen to calls automatically.

d. PIN code: Default password "0000" , and can be change by yourself click "0000"

e. Default Bluetooth name for this unit: BOSS AUDIO BV9979B.

### 2. Function area:

a. Click and see the dialing keypad, users can dial no. and make phone calls.

b. Click to see the Bluetooth phonebook menu.

c. Click to see the Bluetooth call history.

d. Bluetooth music

e. Bluetooth pairing interface as following.

f. Bluetooth setting menu.

# BLUETOOTH OPERATION

## BLUETOOTH DIALING



1. Shows the number you press in, and press  to delete wrong number.
2. Key area.
3. Touch to call out.

## BLUETOOTH CALL

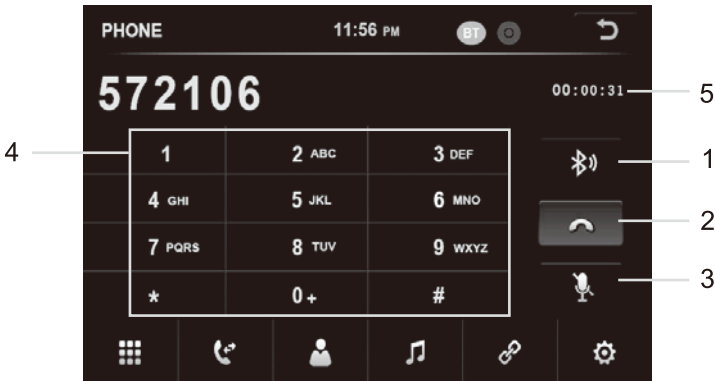

1. Touch to select talk through phone or through Bluetooth.
2. Press to hang up the phone call.
3. Touch to mute or un-mute mic.
4. Keypad area.
5. Show talking time.



# BLUETOOTH OPERATION

## BLUETOOTH PHONE BOOK

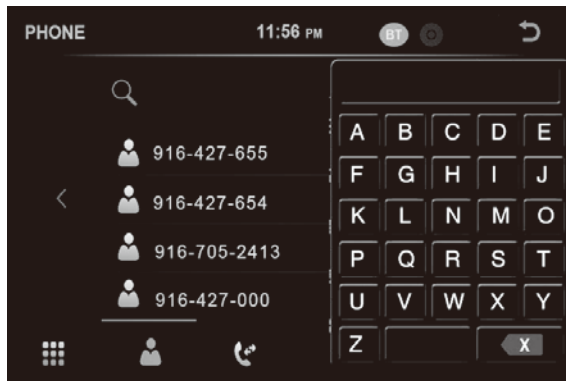
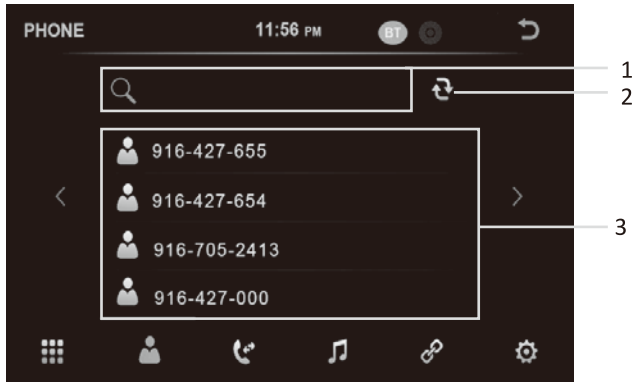

- 1.Touch to enter name and search the wanted phone number.
- 2.Click to sync phonebook.
- 3.Contact list.

# BLUETOOTH OPERATION

## BLUETOOTH PHONE CALL HISTORY

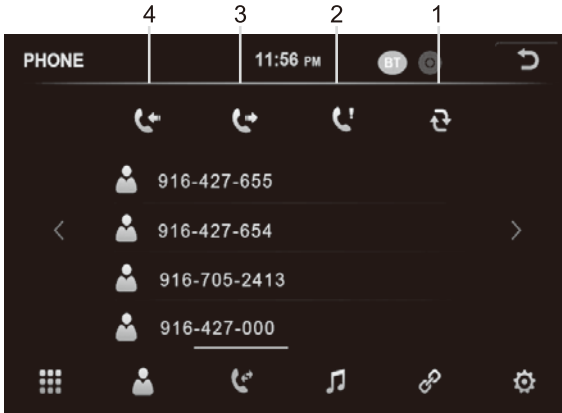

1. Click to sync phonebook.
2. Touch to show missed calls.
3. Touch to show the dialed phone number.
4. Touch to show the received phone number.

## BLUETOOTH MUSIC-A2DP

1. Previous song
2. Play/pause.
3. Next song
4. Enter EQ setting menu.

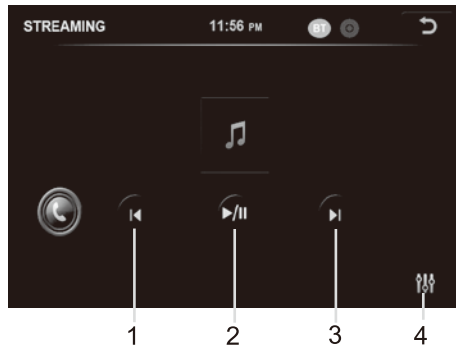

## BLUETOOTH PAIR DEVICE

1. Disconnect the phone.
2. Connect the phone.
3. Delete the phone.

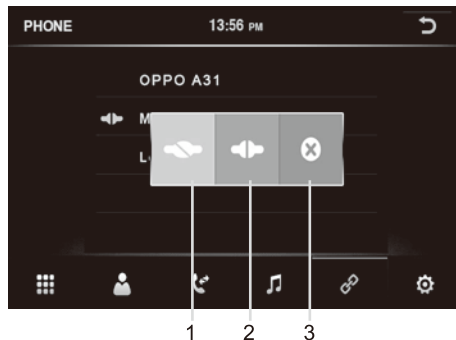

**PHOTO**



- 1.Touch to select one of the two Menu Control Bars:1/3,2/3,3/3.
- 2.Keypad: enter number to select file.
- 3.Previous one.
- 4.PLAY/PAUSE: touch to begin play. Press again the icon to pause.  
During picture playing mode, one picture will be played for 5s automatically and goes to the next if you do not press it.
- 5.Next one.
- 6.List: Press to enter file list.
- 7.Read mode select.
- 8.Random play.
- 9.Enter into setting menu for brightness, and contract.
- 10.Turn right 90 degrees.
- 11.Zoom out/in the present picture.
- 12.Show the number of the picture files.

# CAMERA/AUX/AV MENU

---

**CAMERA:** Rear view function, the rear view video signal can display automatically when you reversing the car, and back to the last sources after reversing the car.



**AUX IN:** External audio input function

Connect the audio device to the unit by the 3.5mm jack in front of the panel and touch AUX INPUT icon.

**AV INPUT:** External video and audio input function

Connect the video and audio device to the unit by the RCA jacks and touch AV INPUT icon.

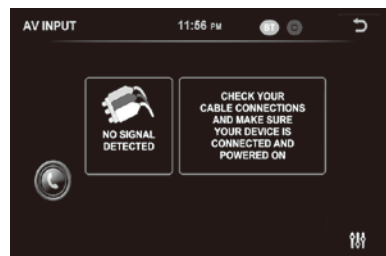
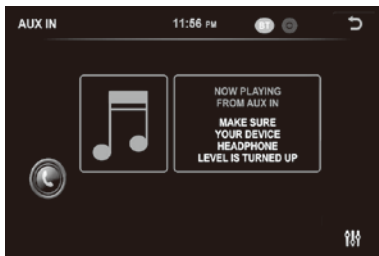

# TROUBLESHOOTING

**Table 1: Error message**

Media displayed	Cause	Corrective Action
Loading	Disc is being read	
No Disc/Bad Disc	Disc is dirty	Clean the disc
	Disc is upside down	Insert Disc in right way
Unknown Disc	Unsupported Disc type	Check the disc and change one
Error	Illegal mechanism operation	Press EJECT for 5s to reset loading mechanism

# TROUBLESHOOTING

---

**Table 2: General problems**

Problem	Cause	Corrective Action
Unit will not power on	Radio fuse blown	Install new fuse with right rating
	Car battery fuse blown	Install new fuse with right rating
	Illegal operation	Press the RESET button
Screen touch is insensitive	Place of touch screen is offset	Go to setup menu and set the calibration
No audio output	Improper audio output connection	Check wiring and correct
	VOLUME 0	Turn up the volume
	Improper MUTE connection	Check wiring and TEL MUTE connection
	Speaker damaged	Change speakers
Low audio output	Volume set too low	Increase the volume
	Heavily biased volume balance	Check and adjust the channel balance to the center position
Poor sound quality or distortion	Speaker power rating not compatible with unit	Connect proper speakers
	Speaker is shorted	Check speaker contrast

# **TROUBLESHOOTING**

**Table 3: TFT monitors**

Problem	Cause	Corrective Action
No image	Incorrect connection to parking wire	Check wiring and correct
	Parking brake is not engaged	Stop vehicle in safe place and set parking brake ON
Flashing image or interference appears on screen	DVD is not compatible with current TV system settings	Change setup to accommodate Disc
	Improper video signal connections	Check wiring and correct
Improper image, improper height/width ratio display	Improper aspect ratio setup	Use correct aspect ratio setting

**Table 4: Tuner**

Problem	Cause	Corrective Action
Weak station searching	Auto antenna is not fully extended	Connect the auto antenna properly
	LOCAL function is activated	Turn LOCAL function OFF

# TROUBLESHOOTING

---

**Table 5: Disc**

Problem	Cause	Corrective Action
Cannot insert Disc	Disc already inside unit	Eject the current Disc and insert the new one
Lots of noise during play, and stop then	Disc is scratched or warped	Use a new one in good condition
	Disc is dirty or wet	Clean the Disc
No repeat or searching while playing VCD	PBC is ON	Turn PBC OFF



# USER'S MANUAL

BV9979B

BLUETOOTH® | DVD/MP3/CD AM/FM RECEIVER



BOSS Audio Systems  
3451 Lunar Court • Oxnard, CA 93030

[www.bossaudio.com](http://www.bossaudio.com)

800-999-1236 US Toll-free

805-988-0192 US Local Main

tech support: [www.bossaudio.com/support/technical-support](http://www.bossaudio.com/support/technical-support)



1216

iPod® and iPhone® are trademarks of Apple, Inc. registered in the U.S. and other countries.  
BOSS Audio Systems is not affiliated with Apple, Inc.  
The Bluetooth® word mark and logos are registered trademarks owned by Bluetooth SIG, Inc. and any use of such marks by BOSS Audio Systems is under license. Other trademarks and trade names are those of their respective owners.