

Model/Modelo/Modèle

35862LF▲

Series/Series/Seria

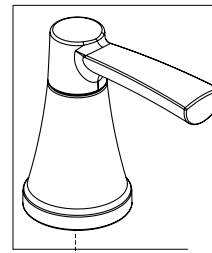

RP101879▲
Handle Assemblies
Conjunto de manija
Montage de la manette

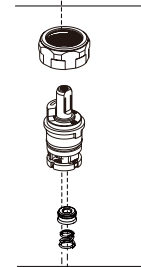

RP101504
Stem Unit Assembly, Seat & Spring,
Bonnet Nut & Washer
Ensamble de la Unidad del Vástago,
Asiento y Resorte, Bonete y Arandela
Obturbador, siège et ressort, écrou à
chapeau et rondelle

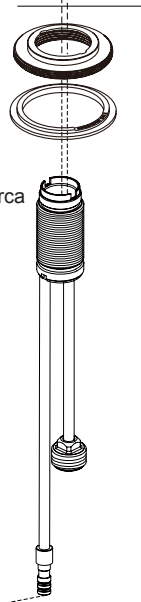

RP101881▲
Waterway, Handle base-Cold Side
Canal, base de la manija-Lado Frío
Voie navigable, base de poignée - Eau Froide

RP101880▲
Waterway, Handle base-Hot Side
Canal, base de la manija-Lado Caliente
Voie navigable, base de poignée - Eau Chaude

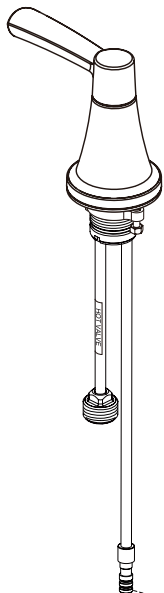

RP101876
1.2 GPM (4.5 L/Min)
Aerator & Wrench
Aérateur et Clé

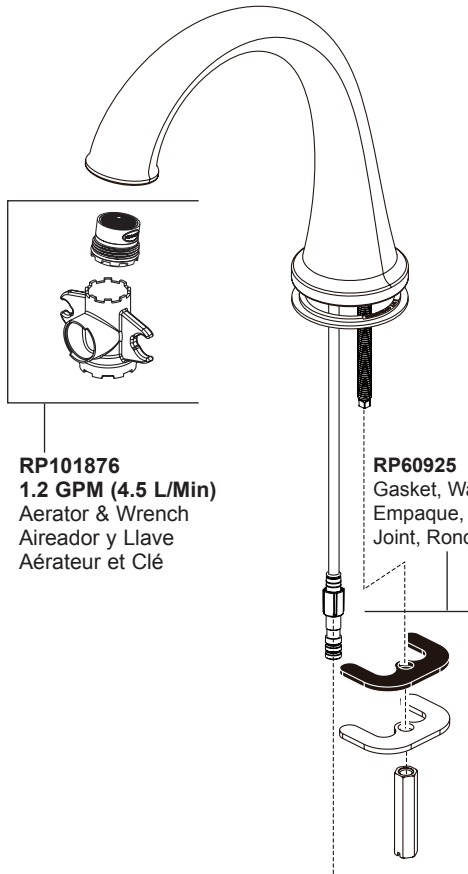

RP60925
Gasket, Washer & Nut
Empaque, Arandela y Tuerca
Joint, Rondelle et Écrou

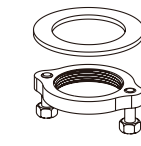

RP101297
Washers (2), Nuts (2)
& Screws (4)
Arandelas (2), Tuercas (2)
y Tornillos (4)
Rondelles (2), Écrous (2)
et Vis (4)

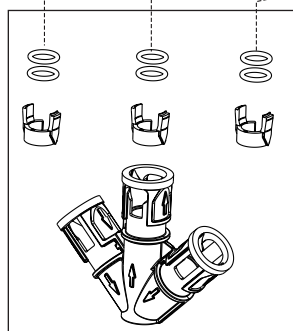

RP101296
Blocks & O-Rings
Bloques y Aros-O
Blocs de fixation et joints toriques

RP100137▲
Push Pop-UP with Overflow
Control de rebose para
desagües manuales
Mécanique à poussoir avec trop-plein

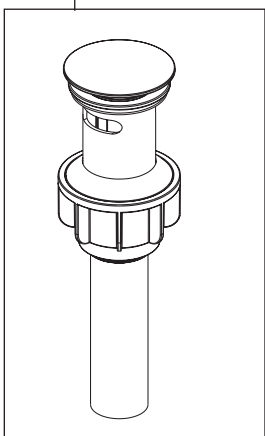

▲ Specify Finish / Especificque el acabado / Précisez la Finition